



Operating Instructions

LCM-3G Series



LCM-3G Series

LCM-207-3G

LCM-307-3G

LCM-209-3G

LCM-119-3G

LCM-123-3G

LCM-132-3G

LCM-147-3G

PRECAUTION	4
1. OVERVIEW	7
2. GENERAL FEATURES	7
3. FUNCTIONAL EXPLANATION OF EACH PART	8
1) FRONT PANEL	8
<i>LCM-119-3G</i>	8
<i>LCM-123-3G</i>	9
<i>Front Keys Arrangements</i>	9
<i>Front Keys Operations</i>	9
<i>Front panel LED Operations</i>	10
2) REAR PANEL	11
<i>LCM-119-3G</i>	11
<i>LCM-123</i>	11
<i>Connection Details</i>	11
<i>Interface description</i>	12
4. MENU OVERVIEW	12
1) TO SHOW AND REMOVE THE MENU	13
2) TO GO TO THE NEXT LEVEL	13
3) TO GO BACK TO THE PREVIOUS LEVEL	13
4) TYPICAL MENU OPERATION	13
5. BASIC OPERATION	14
1) TURNING ON THE MONITOR	14
2) ON SCREEN MENU LANGUAGE SELECTION	14
6. ON SCREEN MENU SELECTION AND ADJUSTMENT	14
1) HOW TO ADJUST THE OSD SCREEN	14
7. SELECT VIDEO INPUT	15
1) HOW TO SELECT VIDEO SOURCE BY OSD	15
8. COLOR MENU	16
1) ADJUST	16
2) COLOR SELECT	17
3) BACKLIGHT ADJUST	17
4) GAMMA SELECT	17
5) MONO/BLUE ONLY	17
9. IMAGE MENU	18
1) ASPECT RATIO	18
2) SCAN	18
3) ZOOM	18
4) NR (NOISE REDUCTION)	19
5) PC MENU (PC MODE ONLY)	19
10. MARKER MENU OPTIONS	19
1) MARKER & USER MARKER	19

2)	SAFETY MARKER	20
3)	CENTER MAKER	20
4)	MARKER WIDTH	21
5)	MARKER COLOR	21
6)	SAFETY MARKER COLOR	21
11.	SYSTEM MENU	22
1)	SETUP LOAD & SETUP SAVE	22
2)	FUNCTION KEY	22
3)	ON SCREEN DISPLAY	23
	<i>OSD Option</i>	23
	<i>Under Monitor Display (color: Tally R/G mode action)</i>	23
	<i>ID Style</i>	24
4)	SET ID & ACTIVE SET ID	24
12.	ADVANCED MENU	25
1)	ADVANCED	25
2)	INFORMATION	25
3)	OPTION	25
4)	SCREEN CONTROL	26
5)	NETWORK CONFIG	26
13.	PIP MENU (PICTURE IN PICTURE)	27
1)	PIP ON/OFF	27
2)	INPUT SOURCE	27
3)	ASPECT RATIO	28
4)	POSITION	28
5)	PIP BLEND	29
6)	IP SWAP	29
14.	OSD TREE	30
1)	COLOR	31
2)	IMAGE	31
3)	MARKER	32
4)	SYSTEM	33
5)	ADVANCED	34
6)	PIP	35
15.	SPECIFICATIONS	36
1)	PANEL SPECIFICATIONS	36
2)	SUPPORTED SIGNALS	37
3)	SUPPORTED TIMINGS	38
	<i>PC & DVI input</i>	38
16.	MECHANICAL DIMENSIONS	42

Precaution

Before operating the set, please read this manual carefully.

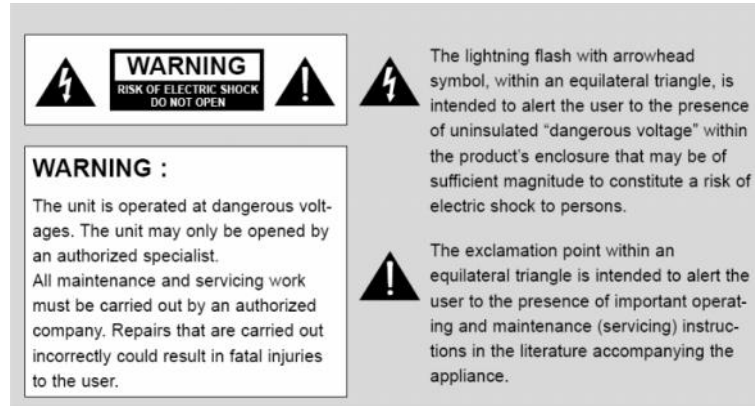

The image shows a collection of warning labels and symbols. On the left, there is a rectangular label with a lightning bolt symbol on the left and an exclamation mark symbol on the right. The text in the center reads: **WARNING**
RISK OF ELECTRIC SHOCK
DO NOT OPEN. Below this is another rectangular label with the heading **WARNING :** followed by the text: The unit is operated at dangerous voltages. The unit may only be opened by an authorized specialist. All maintenance and servicing work must be carried out by an authorized company. Repairs that are carried out incorrectly could result in fatal injuries to the user. To the right of these labels are two explanatory paragraphs. The first paragraph, preceded by a lightning bolt symbol, explains that the lightning flash with arrowhead symbol, within an equilateral triangle, is intended to alert the user to the presence of uninsulated "dangerous voltage" within the product's enclosure that may be of sufficient magnitude to constitute a risk of electric shock to persons. The second paragraph, preceded by an exclamation mark symbol, explains that the exclamation point within an equilateral triangle is intended to alert the user to the presence of important operating and maintenance (servicing) instructions in the literature accompanying the appliance.

WARNING:

To reduce the risk of any electric shock, do not remove back cover as there are no user serviceable parts inside. Please refer to Plura or a qualified service personnel/agent. To prevent fire or shock hazard, do not expose the rear side of the unit to rain or moisture. Do not rub or clean the Active Matrix LCD with any harsh surface as this may scratch, mark, or damage the Active Matrix LCD permanently.

CAUTION:

Unauthorized tampering with the inside of the monitor voids the warranty.

The manufacturer shall not warrant for any damage caused by improper maintenance and/or repair by any third party.

Important safeguards for you and your new product:

Please read and observe the following safety points when installing and using your new device and save them for future reference.

1. **Read Instructions**
2. **Follow Instructions**
All operating and use instructions should be followed.

3. **Retain Instructions**

The safety and operating instructions should be retained for future reference.

4. Observe Warnings

All warnings on the product and in the operating instructions should be adhered to.

5. Cleaning

Disconnect the unit from the mains before cleaning. Do not use abrasive cleaners. Use a damp cloth for cleaning.

6. Water and Moisture

Do not use this unit near water.

7. Transportation

A product should be transported with care. Excessive force and uneven surfaces may cause the damage to product.

8. Attachments

Do not use attachments not recommended by Plura as they may cause hazards.

9. Ventilation

Do not block any of the ventilation openings.

Install in accordance with the manufacturer's instructions.

10. Power Sources

This product should be operated only from the type of power source indicated on the marking label. If you are not sure of the type of power supply, consult your power company.

11. Power Lead Polarization

This product is equipped with a three-wire grounding-type cord. This is a safety feature. Do not use an alternative power cord.

12. Power Cord Protection

Power-supply cords should be protected so that they are not likely to be walked on or pinched by items placed upon or against them, paying particular attention to cords at plugs, convenience receptacles and the point where they exit from the product.

13. Outdoor Cable Grounding

If an outdoor cable is connected to the product, be sure the cable is grounded to provide some protection against voltage surges and built-up static charges. A "face plate" also needs to be installed with an isolating capacitor to prevent any damage from static.

14. Lightning

For added protection for this product during a lightning storm, or when it is left unattended and unused for long periods of time, unplug it from the wall outlet. This will prevent possible damage to the product due to lightning and power-line surges.

15. Earthing the product

This product must be earthed properly to comply with the safety regulations in the country of use. If you are unsure of these regulations, please consult a qualified electrician.

16. Servicing

Do not attempt to service this product yourself as opening or removing covers may expose you to dangerous voltages or other hazards. Refer all servicing to qualified service personnel. If the device does not operate properly, switch it off and call your dealer.

17. Service

Turn this product off, unplug from the mains supply and refer servicing to qualified service personnel under the following conditions:

- A. *If the power-supply cord or plug is damaged.*
- B. *If the LCD has been damaged.*
- C. *If water or moisture penetrated the glass and/or the LCD screen.*
- D. *If the product does not operate normally by following the operating instructions. Adjust only those controls that are covered by the operating instructions as an improper adjustment of other controls may result in damage and will often require extensive work by a qualified technician to restore the product to its normal operation.*
- E. *If the product has been dropped or the frame has been damaged.*
- F. *If the product exhibits a distinct change in performance.*

18. Safety Check

Upon completion of any service or repairs to this product, ask the service technician to perform safety checks to determine that the product is in proper operating condition and the front seal is intact.

19. Mounting

The product should be mounted on a wall only as recommended in the instructions.

20. Power

This device operates on an AC supply; the voltage is as indicated on the label on the Manual. This device must be earthed at all times through the chassis as well as through the power lead.

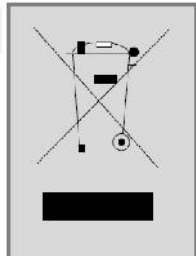
 Note		<p>This product is designed and manufactured with high quality materials and components which can be recycled and reused. This symbol means that electrical and electronic equipment, at their end-of-life, should be disposed of separately from your household waste.</p> <p>Please, dispose of this equipment at your local community waste collection/recycling centre.</p> <p>In the European Union there are separate collection systems for used electrical and electronic product.</p> <p>Please, help us to conserve the environment we live in!</p>
---	---	---

1. OVERVIEW

LCM Series consists of high quality HD LCD monitors, specifically designed for use in Broadcast environment ensuring accurate color reproduction in accordance with SMPTE, EBU, REC 709 Broadcast Standards. It supports up to 3Gbps-1080-60P along with all other Digital & Analog inputs & formats, Composite/RGB/PC-RGB/DVI/HDMI/Component.

2. GENERAL FEATURES

- SDI 2 Input / 2 Output.
- Color Temperature – User, VAR, 11000K, 9300K, 7500K, 6500K, 5000K and 3200K
- Over Scan/Under Scan/ 1:1 scan/ Zoom
- PIP (Picture In Picture)/PIP Blend
- Supports VESA DDC2B and a subset of VESA standards.
- Single board is suitable for mounting behind an LCD panel.
- Supported ETHERNET/Firmware Upgrade.
- OSD: Graphic based OSD, 6 Languages (UNICODE System).
- LCD Dimming Control
- Manual Dimming Level Control.
- ETHERNET: Network System Controller / Update
- Rack Mount.

3. Functional explanation of each part

1) Front Panel

LCM-119-3G

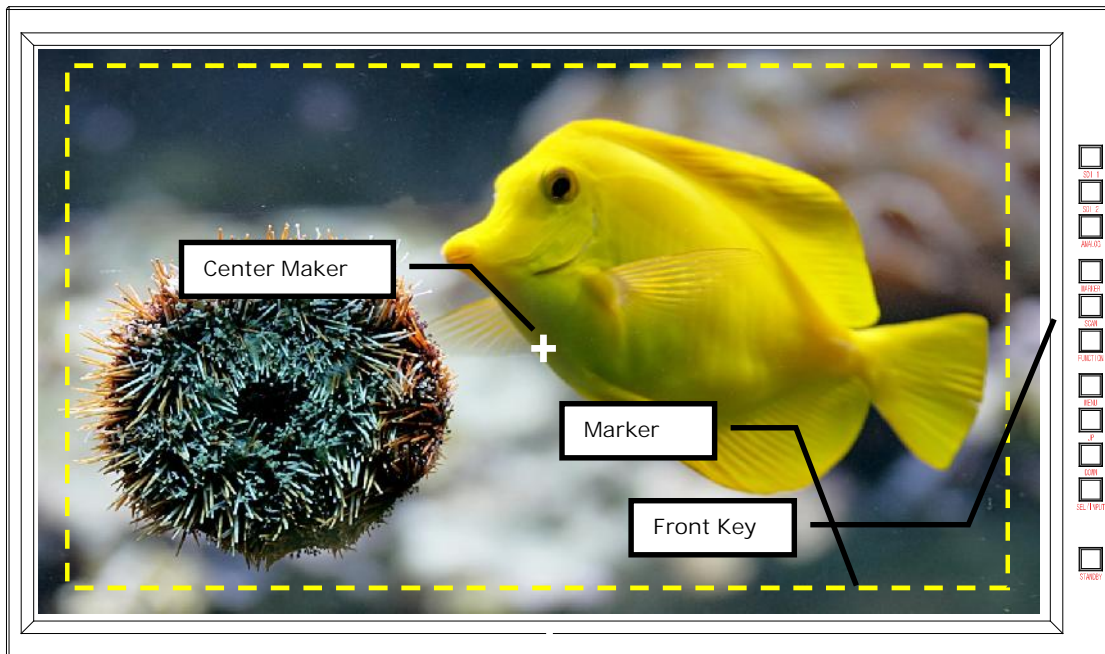

LCM-123-3G

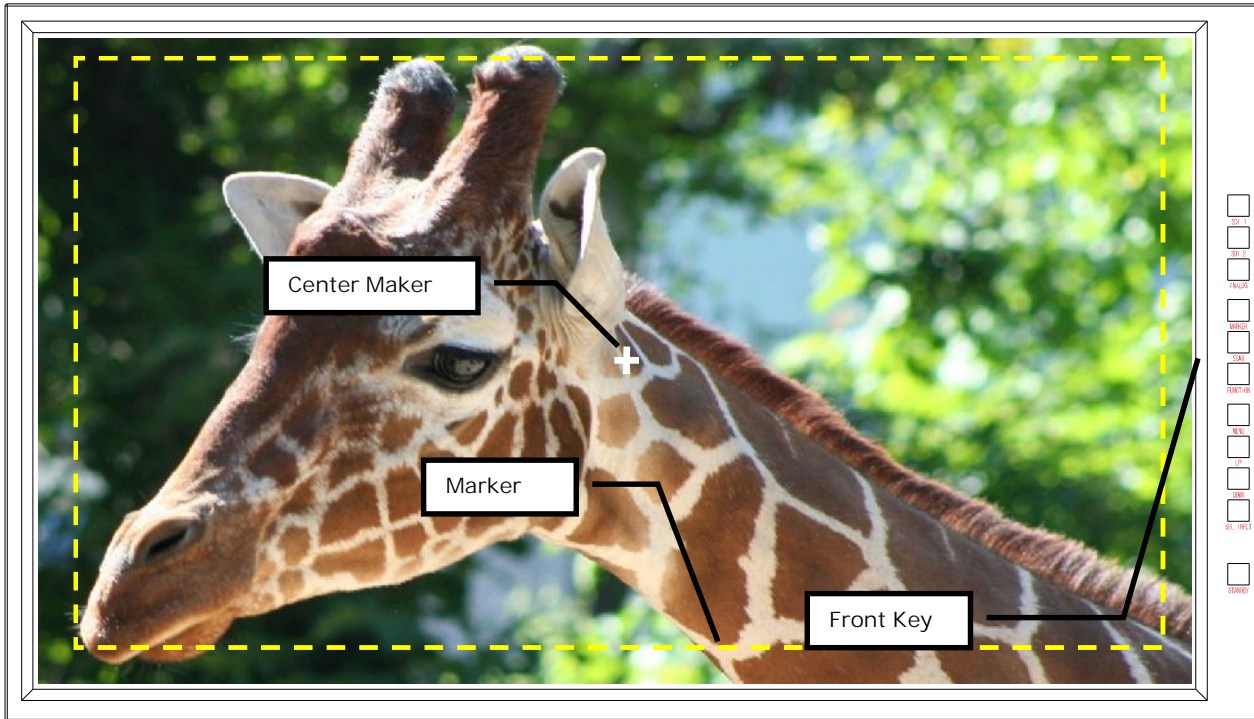

Front Keys Arrangements

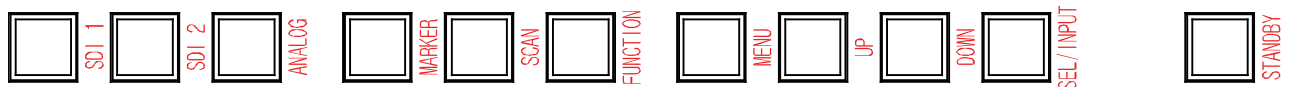

Front Keys Operations

Key Name	Operation
STANDBY	▶ Power ON/OFF Button. This button is operated after being pressed about 3 seconds.
SEL/INPUT	<ul style="list-style-type: none"> ▶ Activates OSD menu of selected input source. ▶ Changes input source. ▶ Executes functions (by OSD help commands) in main OSD menu.
DOWN	▶ Decreases values of user menu in main OSD menu.

	<ul style="list-style-type: none"> ▶ Executes function (by OSD help commands) in main OSD menu.
UP	<ul style="list-style-type: none"> ▶ Increases values of user menu in main OSD menu. ▶ Executes function (by OSD help commands) in main OSD menu.
MENU	<ul style="list-style-type: none"> ▶ Activates main OSD menu. ▶ Navigates higher menu in main OSD menu. ▶ Exits OSD menu.
FUNCTION	<ul style="list-style-type: none"> ▶ Executes user selected functions <p>UNDEF, Aspect, Zoom, Color temp, Gamma select, PIP, PIP Source, PIP size, PIP Position, PIP Swap, Input Composite, Input PC, Input HDMI, Input DVI</p>
SCAN	<ul style="list-style-type: none"> ▶ Executes Scan function (Over-Scan -> Zero-Scan -> Under Scan-> Pixel to Pixel)
MARKER	<ul style="list-style-type: none"> ▶ Draw Marker on Screen (Off -> 16:9 -> 4:3 ... -> 2.35:1)
SDI 1	<ul style="list-style-type: none"> ▶ Select SDI 1 source directly
SDI 2	<ul style="list-style-type: none"> ▶ Select SDI 2 source directly
ANALOG	<ul style="list-style-type: none"> ▶ Select ANALOG source directly <p>('Composite1' ->'Composite2' ->'Composite3' -> 'S-video' -> 'G.B.R' -> 'Y.Pb.Pr' -> 'PC')</p>

Front panel LED Operations

- Green Led will be ON when Power is ON

2) **Rear Panel**

LCM-119-3G

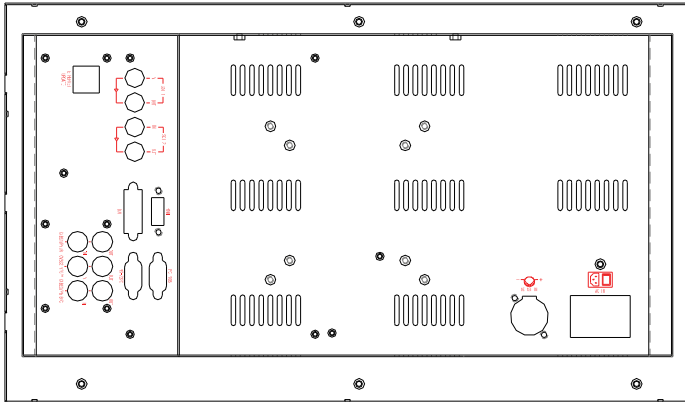

LCM-123

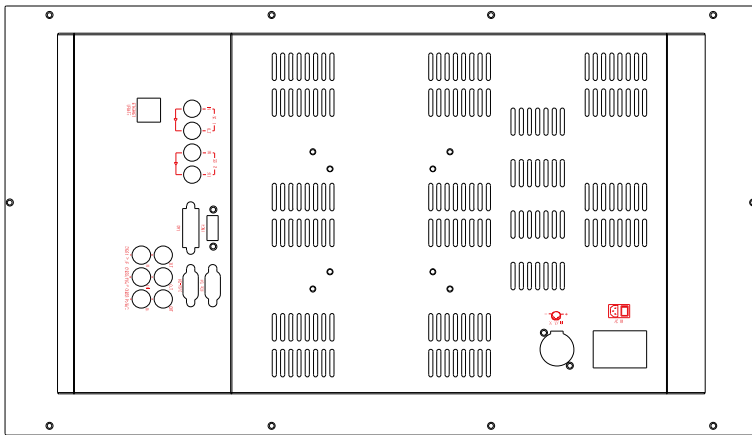

Connection Details

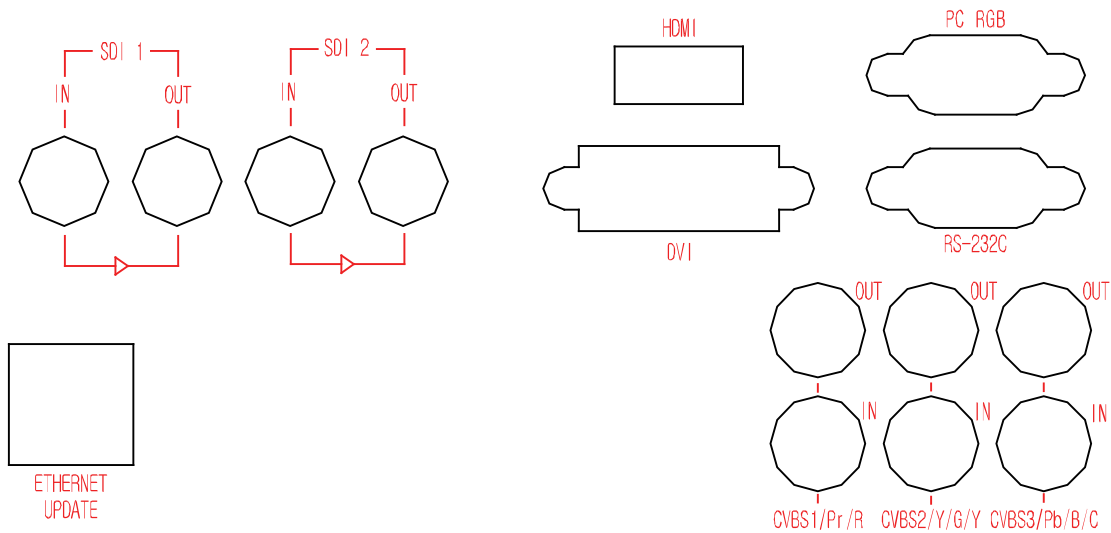

Interface description

Interface	Description
SDI 1 IN	SDI Input
SDI 2 IN	
SDI 1 OUT	SDI 1 Loop Through Output.
SDI 2 OUT	SDI 2 Loop Through Output.
RS-232 IN	Update/Multi Control/Auto color calibration
HDMI	High Definition Multimedia Input
DVI	High Definition Multimedia Input Compatible
ETHERNET UPDATE	ETHERNET/Firmware Upgrade
VGA	Analog PC-RGB Video Input
CVBS1/Pr/R In	GBR (SOG sync) Input Y, Pb, Pr Component Video Input CVBS / Composite/S-Video Input
CVBS2/Y/G/Y In	
CVBS3/Pb/B/C In	
AC IN	AC 90V ~ 240V, 50Hz/60Hz

4. MENU OVERVIEW

In this menu system, there are several ways to customize the menu settings provided.

Most menu consist of three levels to set up the options, but some require greater depth for the variety of settings. If you press the MENU button, only the first and second level of the menu system will appear on the monitor screen. The third level can be displayed by pressing SEL/INPUT. If a menu has more than three levels, the pop-up dialogue box will be displayed as the fourth or fifth level.

1) **To show and remove the Menu**

Press the MENU button to display the menu. A second press of the MENU button will take you back to monitor viewing.

2) **To go to the next level**

Press SEL/INPUT button.

3) **To go back to the previous level**

Press MENU button

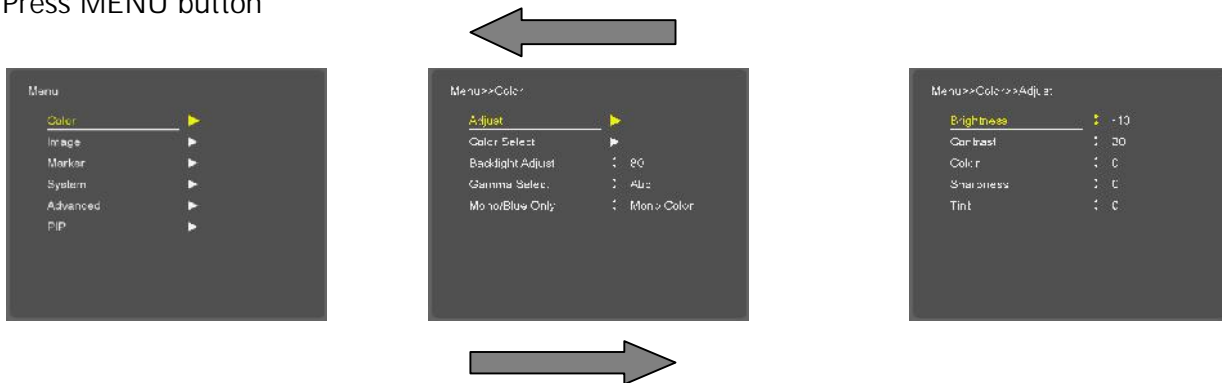

4) **Typical Menu Operation**

1. Press MENU button: The main menu will appear.
2. Use UP/DOWN button to select the desired menu option (icon).
3. While the desired menu option is selected, press SEL/INPUT to move to the second level.
4. Use UP/DOWN button to select the second menu option.
5. Press SEL/INPUT to move to the third level: Some menu options require additional steps.
6. Press MENU to return to the previous menu to return to monitor viewing.

5. BASIC OPERATION

1) **Turning On the Monitor**

1. First, connect power cord correctly. At this moment, the monitor switches to standby or power on mode. In standby mode, in order to turn monitor on, press the ST-BY button.
2. Select the viewing source by using SEL/INPUT button on Keypad in front of monitor

2) **On Screen Menu Language Selection**

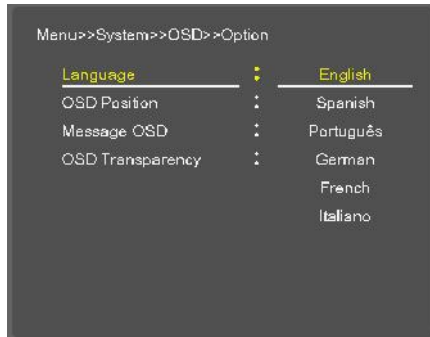

- SETUP -> On Screen Display -> OSD Option -> Language

- The menu can be shown on the screen in the selected language.

- Supported Language: English, Spanish, Portuguese, German, French, Italian

6. On Screen Menu Selection and Adjustment

1) **How to adjust the OSD screen**

1. Press the MENU button and then UP/DOWN button to select each menu.
2. Press the SEL/INPUT button and then use UP/DOWN (SEL/INPUT)/MENU button to display the available menu.

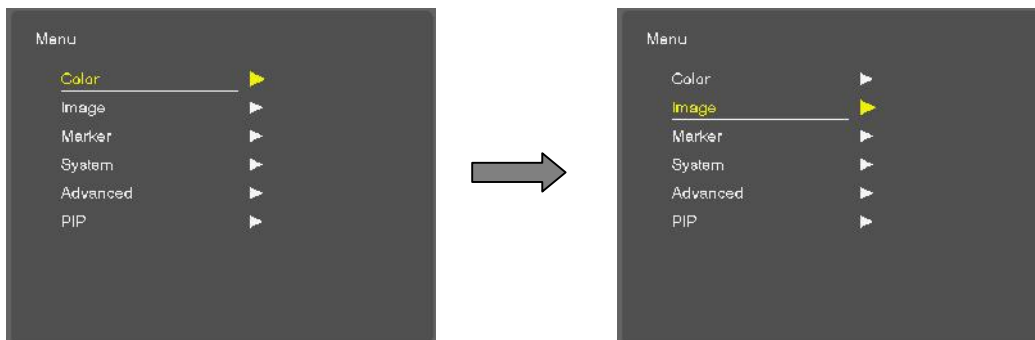



- Your monitor's OSD (On Screen Display) may differ slightly from what is shown in this manual

7. SELECT VIDEO INPUT

1) *How to Select Video Source by OSD*

1. Press the SET/INPUT button and then UP/DOWN button to select the desired video source.
2. Press the SET/INPUT button to go to desired video source.
3. If Input Name is enabled, The SET/INPUT button goes into input name edit mode instead of selecting source.

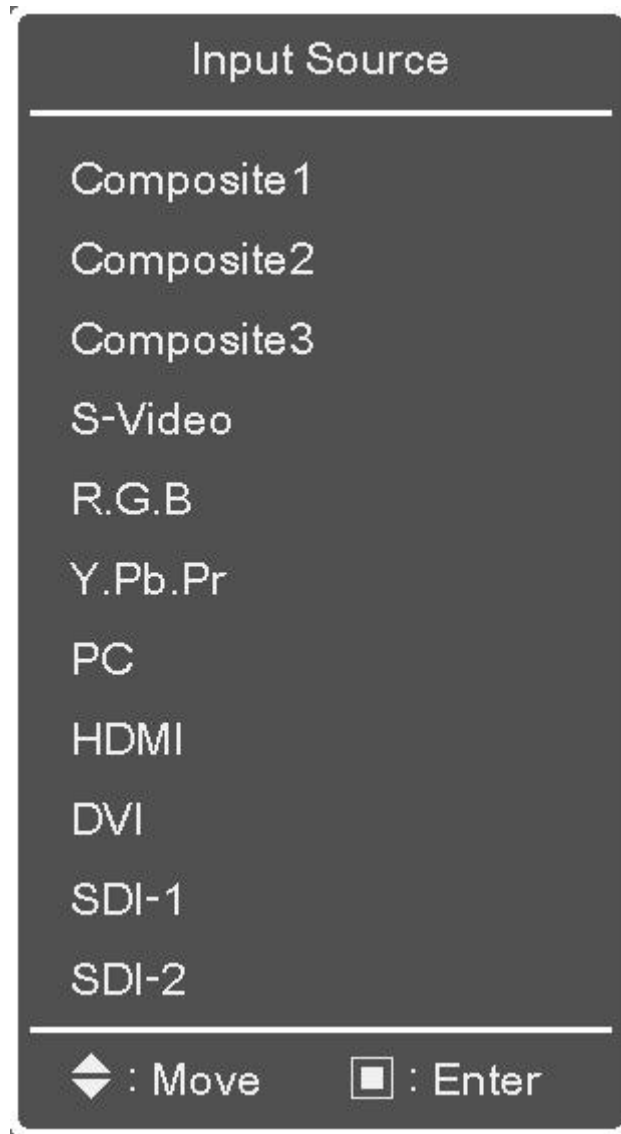

8. Color MENU

1) **Adjust**



- Adjust the values of Brightness, Contrast, Color, Tint and Sharpness directly from -50 to 50

Contrast, Brightness, Sharpness, Color (All Sources), Tint (except PC, Component), Phase (Component).

2) **Color Select**

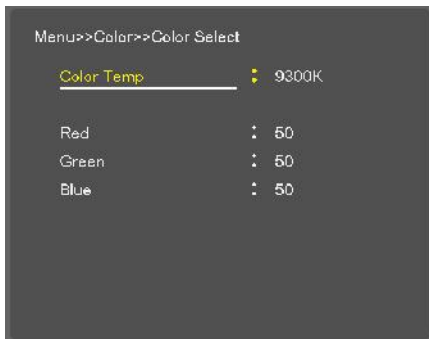

- For Setting the Color temperature or adjusting RGB gain value directly
- User (User setting RGB gain value), VAR(3200K ~ 11000K), Often used value(11000K, 9300K, 6500K, 5400K,3200K)

3) **Backlight Adjust**

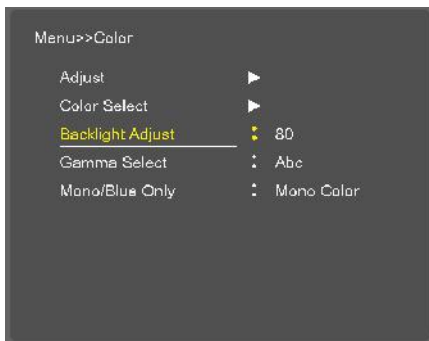

- Inverter dimming Level select (0~100)

4) **Gamma select**

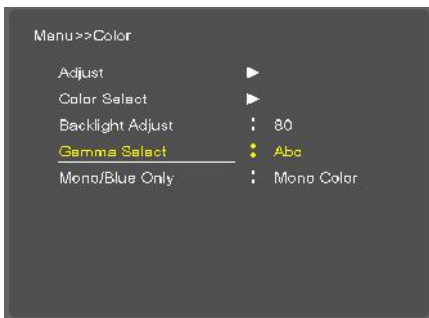

- Gamma Level Select (0.8 ~ 3.0)

5) **Mono/Blue Only**



- Mono color: For selecting monochrome images
- Blue Only: Images have only blue color

9. Image MENU

1) **Aspect Ratio**

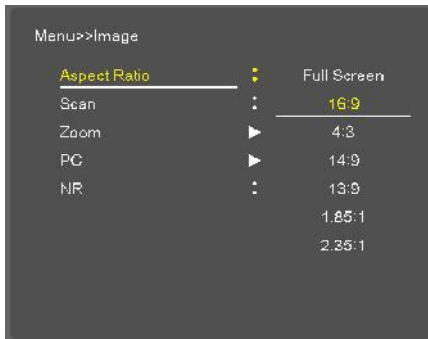

- For setting the aspect ratio.

- Full Screen: The images are displayed with a panel size.

- Full Screen, 16:9, 4:3, 14:9, 13:9, 1.85:1, 2.35:1: The images are displayed with each aspect ratio.

- PC mode: Full Screen & 4:3 only

- Function Aspect: For setting the Aspect to use by Function KEY controller.

2) **Scan**

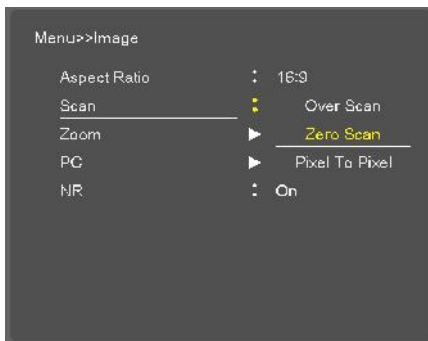

1. Over Scan – 95% input size and fit the selected display size

2. Zero Scan – 100% Input size and fit the selected display size

3. Under Scan – 105% Input size and fit the selected display size

3. Pixel to Pixel – Display size is an input size. If input resolution is bigger than panel size, fit the panel size

3) **Zoom**

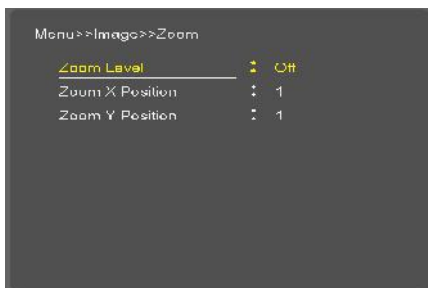

- Can see the enlarged picture by (2X, 3X, 4X, 5X) ratios.

- If user select the Zoom 2X, can see the below yellow box in picture.

- Press Select or Enter button, user can see the enlarged picture.

- Menu key escape the zoom mode.

- Example (3X3)



Zoom X position: Coordinate of video image's column position.

Zoom Y position: Coordinate of video image's row position.

4) **NR (Noise Reduction)**

→ Noise Reduction on/off (NR is for Video signal SD-SDI, Composite, S-Video, Y/Pb/Pr, DTV timing)

5) **PC Menu (pc mode only)**

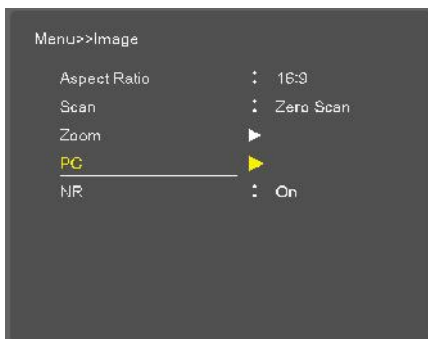

- Only operate PC input mode

- Select Auto-adjust and adjust Phase, HV position, Frequency

- Auto-Adjust automatically set the optimum values of Phase, HV position and Frequency.

10. Marker MENU OPTIONS

1) **Marker & User Marker**



< Marker >

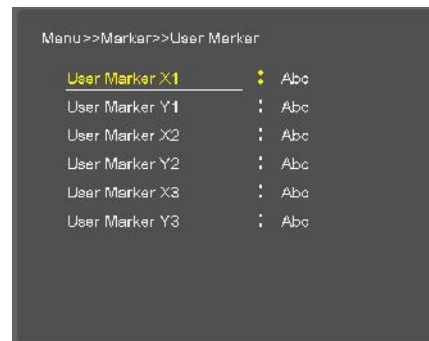

< User Marker >

1. Marker : 16:9, 4:3, 14:9, 13:9, 1.85:1, 2.35:1, 1.85:1&4:3, User1, User2, User3 fitted panel size marker on screen.

2. User Marker: The user Marker size. (Below panel size)

Example (1440x900 panel)



16:9 (16:9 Marker)



16:9 (4:3 Marker)

2) **Safety Marker**



-Safety Area: Draw dotted line Marker on screen for graphics and logo applications. (16:9 95/93/90/88/80%, 4:3 95/93/90/88/80%, EBU Action 16:9/14:9/4:3, EBU Graphic 16:9/14:9/4:3)

3) **Center Maker**



- "+" Marker on center of screen

4) **Marker Width**

-Marker line thickness setting. (0~10)

5) **Marker Color**



- Marker Line Color: Select Marker line color (White, Yellow, Blue, RED, Black)

6) **Safety Marker Color**



- Safety Line Color: Select Safety line color (White, Yellow, Blue, RED, Black)

11. System MENU

1) Setup Load & Setup Save

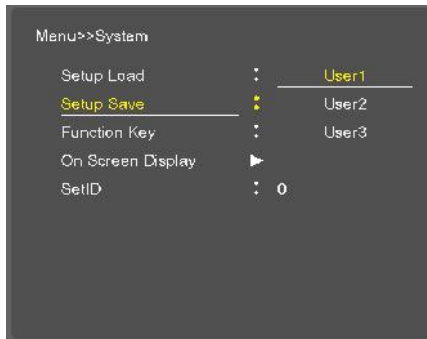
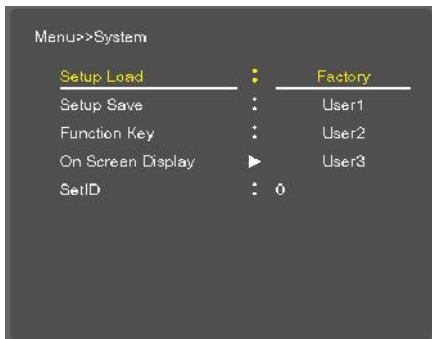

- Setup Load: Load user saved values or default value
- Setup Save: Save user setting values at user 1, 2, 3.

2) Function Key

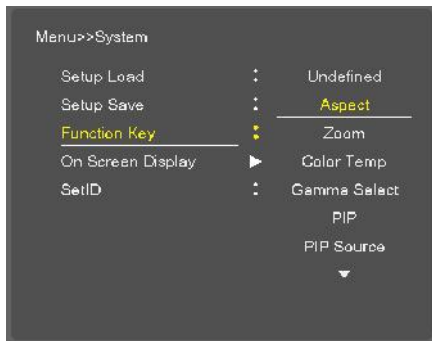

- Function Key: Select the function to be allocated to the FUNCTION buttons

Function Key	Description
UNDEF	Not set (no function allocated)
Aspect	Sets the aspect ratio of the images
Zoom	Zoom function is operated(Off, 2x, 3x, 4x, 5x)
Color Temp	User (User setting RGB gain value), VAR(3200K ~ 11000K),

	Often used value(11000K, 9300K, 6500K, 5400K,3200K)
Gamma Select	Select Gamma curve
PIP	PIP on/off
PIP Source	PIP input Source can operate with different signal and type.
PIP size	Choose PIP size of Small/POP1/POP2
PIP Position	Choose the pip position on the each corner of the pane
PIP Swap	Using Swap option, you can exchange two programs or source at the same time.
Input Composite	Switches the input source.
Input PC	
Input HDMI	
Input DVI	

3) **On Screen Display**

OSD Option

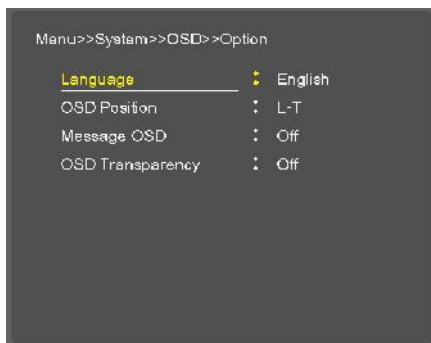

- Language: Select a language for the menu to appear in. (English, Spanish, Portuguese, German, French, Italian)
- OSD Position: L-T, R-T, C, L-B, R-B
- Message OSD: Input Source Message on/off.

→ OSD Transparency: Disable blending OSD background with video image.

Under Monitor Display (color: Tally R/G mode action)



UMD

- UMD: UMD display on/off
- UMD Character: UMD Character Select
- UMD Position: UMD display position select (L-T, C-T, R-T, L-B, C-B, R-B)
- UMD FG Color: UMD Character color Select (RGB_255_192_128_Transparent)
- UMD BG Color: UMD BG color Select (RGB_255_192_128_Transparent)

ID Style

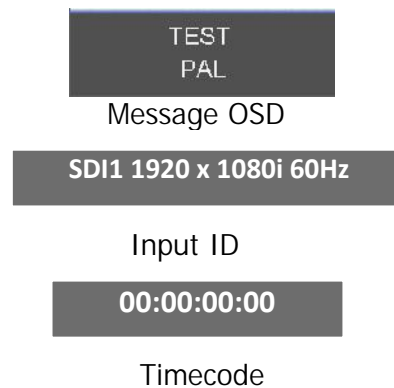
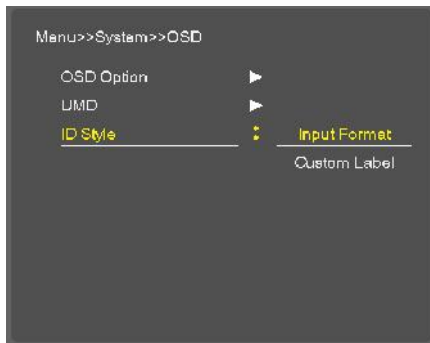

- Input ID: source Message display.
- ID Style: select "Input Format"/"Custom Label"
- Input Label: Display user made name instead of input source name on source OSD and message OSD



4) **Set ID & Active Set ID**

- To control this monitor remotely you need to set a unique ID number (01~99).



- Set Active SET ID number is the max number of monitors' controlled remotely via Ethernet or RS-232
- If your monitor control network consists of 15 monitors, then Active SET ID must set to 15.

12. Advanced MENU

1) **Advanced**

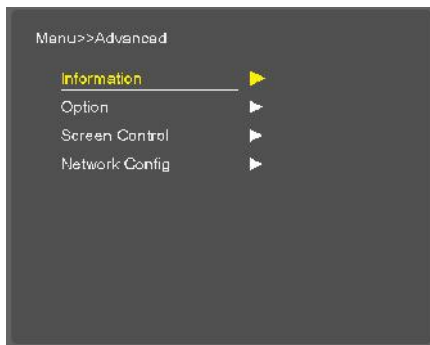

- Information, Option, Screen Control, Network Config

2) **Information**

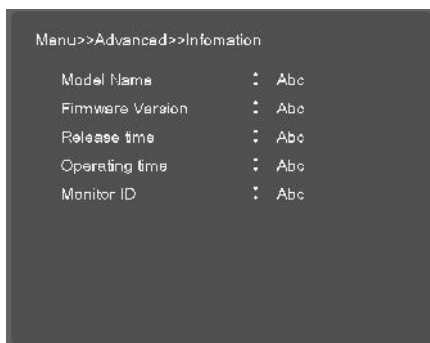

- Model Name, Firmware Version, Release time, operating time, Monitor ID

3) **Option**

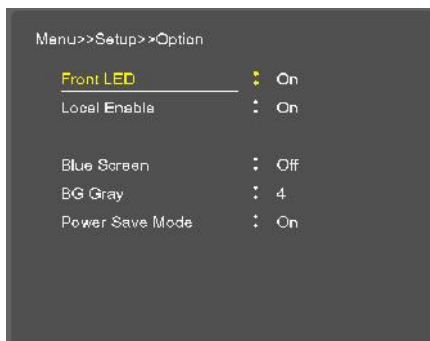

- FRONT LED: Front LED on/off

- Local Enable: Power, up and down key is only worked, if Local enable is off.

- Blue Screen: Enables screen saver functions to avoid panel burning.
- BG Gray: Select gray level on besides display picture
- Power save Mode: Power Save Mode on/off

4) **Screen Control**

-Reset Calibration

→Color Calibration Reset

-I/P Mode

→ Line Doubler/inter-Field/Field Merge function on/off

-Dithering

→Dithering function on/off

- Internal Pattern:

→100% Color Bars, 75% Color Bars, Luma, RGB, White, Black, RED, Blue, Green

5) **Network Config**

-Plura System Controller (PSC-400) Network setting.

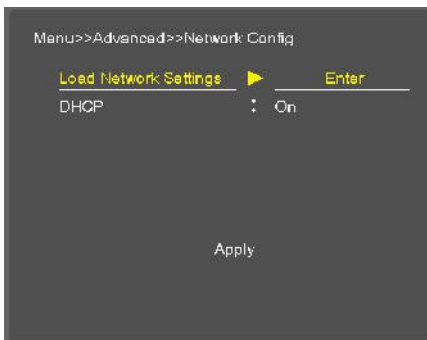

→Load Network Settings: ETHERNET configuration Press "Enter".
(ID/IP Address/Gateway/Subnet Load)



→DHCP: DHCP on/off (Manual IP settings – DHCP on)

* "Apply" enter all settings.

13. PIP MENU (Picture IN Picture)

- Watch two programs or sources at the same time. And set up PIP size and position.

1) **PIP ON/OFF**

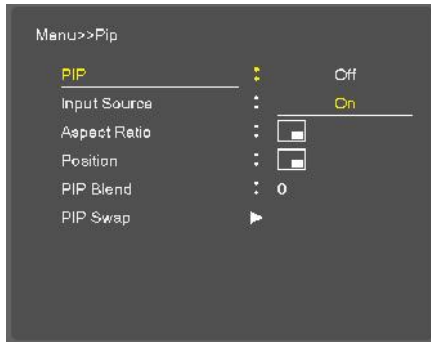

- Control PIP function On/Off.

2) **Input Source**

- PIP input Source can operate with different signal and type.

- Analog (Composite1, 2, 3, Y.Pb.Pr, GBR, PC) inputs + SDI (SDI1, SDI2) inputs

-SDI + SDI input PIP

Ex) AV + S-Video (X), AV +SDI2 (O)

3) *Aspect Ratio*

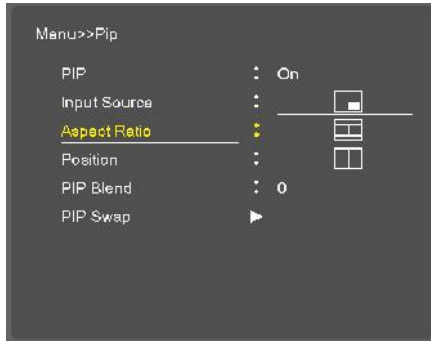

- Choose PIP size of Small/POP1/POP2



PIP Small



PIP1



POP2

4) *POSITION*

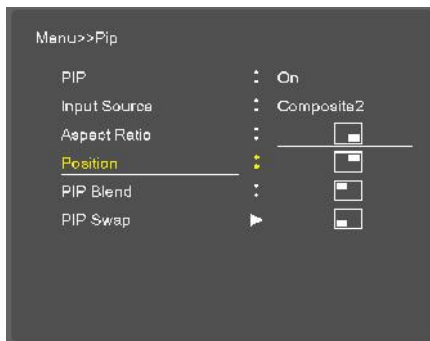

- Choose the pip position on the each corner of the panel

5) **PIP Blend**



-Blend to PIP size of Small

6) **IP Swap**

- Using Swap option, you can exchange two programs or source at the same time.

14. OSD TREE

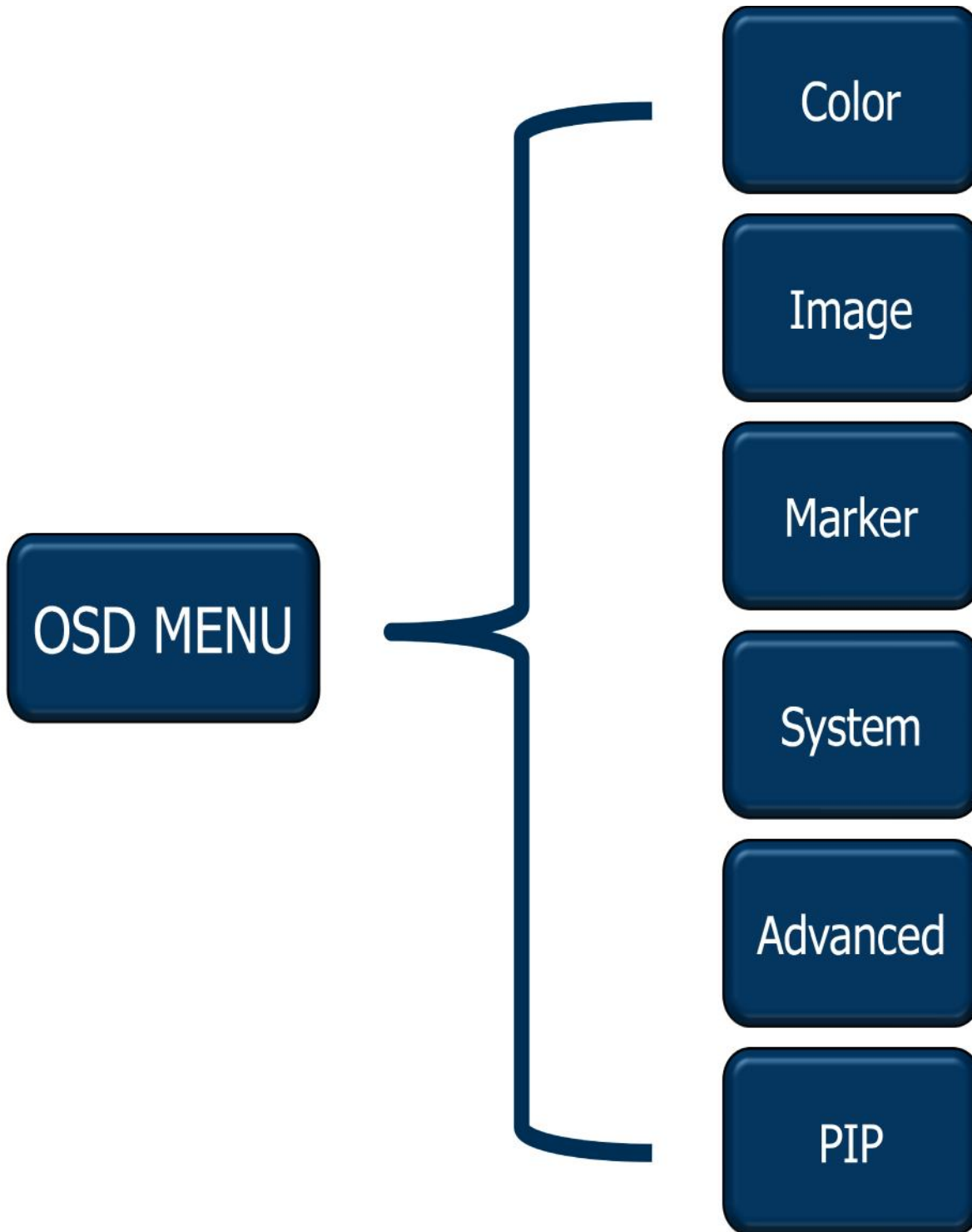

1) **Color**

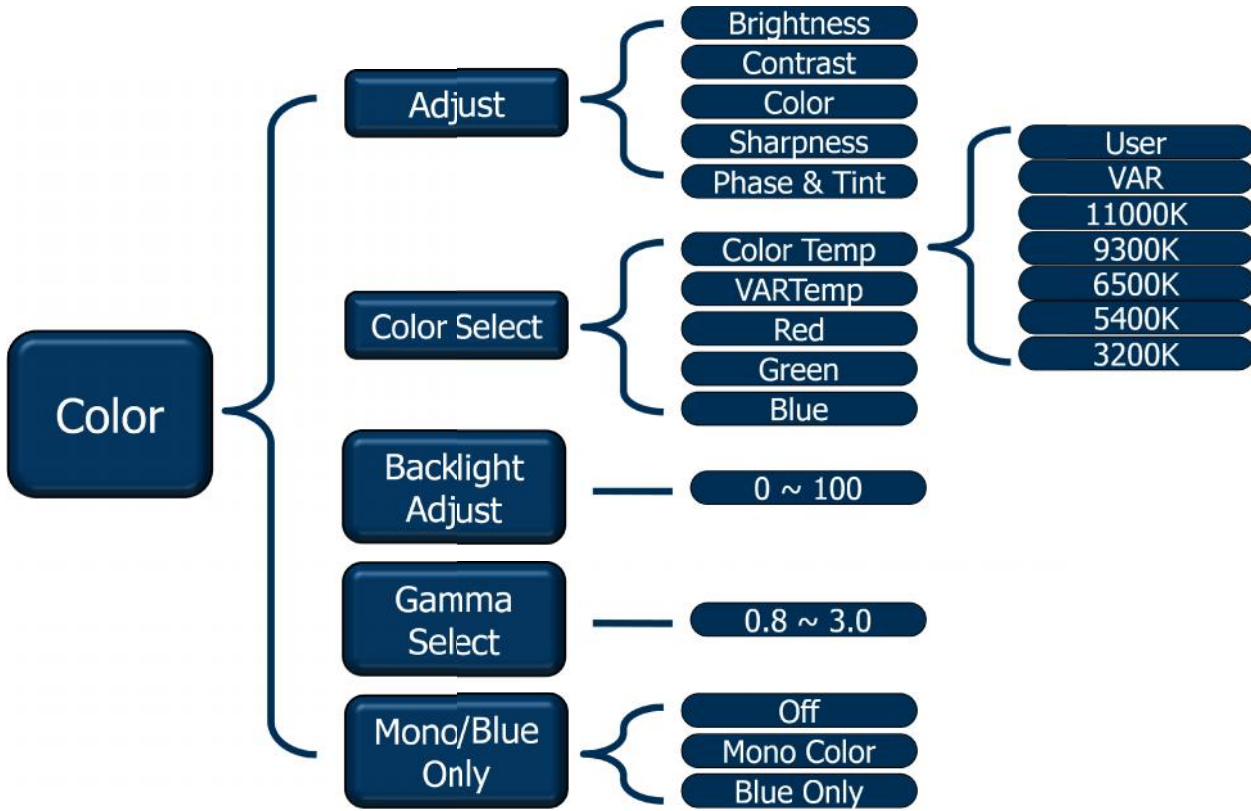

2) **Image**

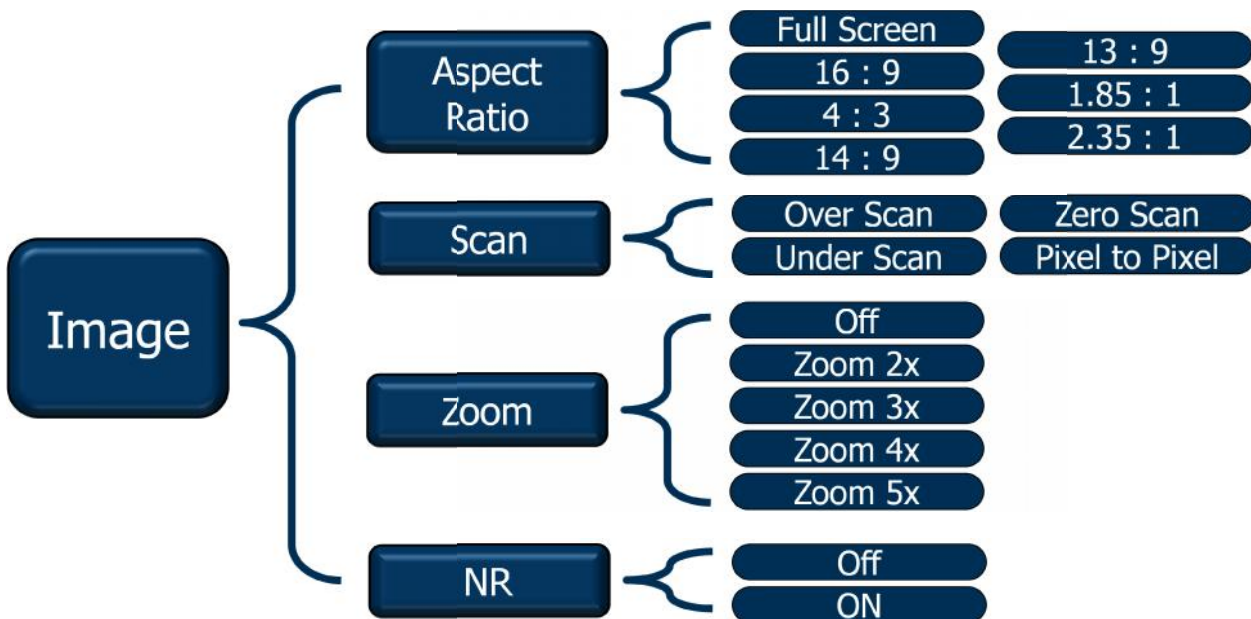

3) **Marker**

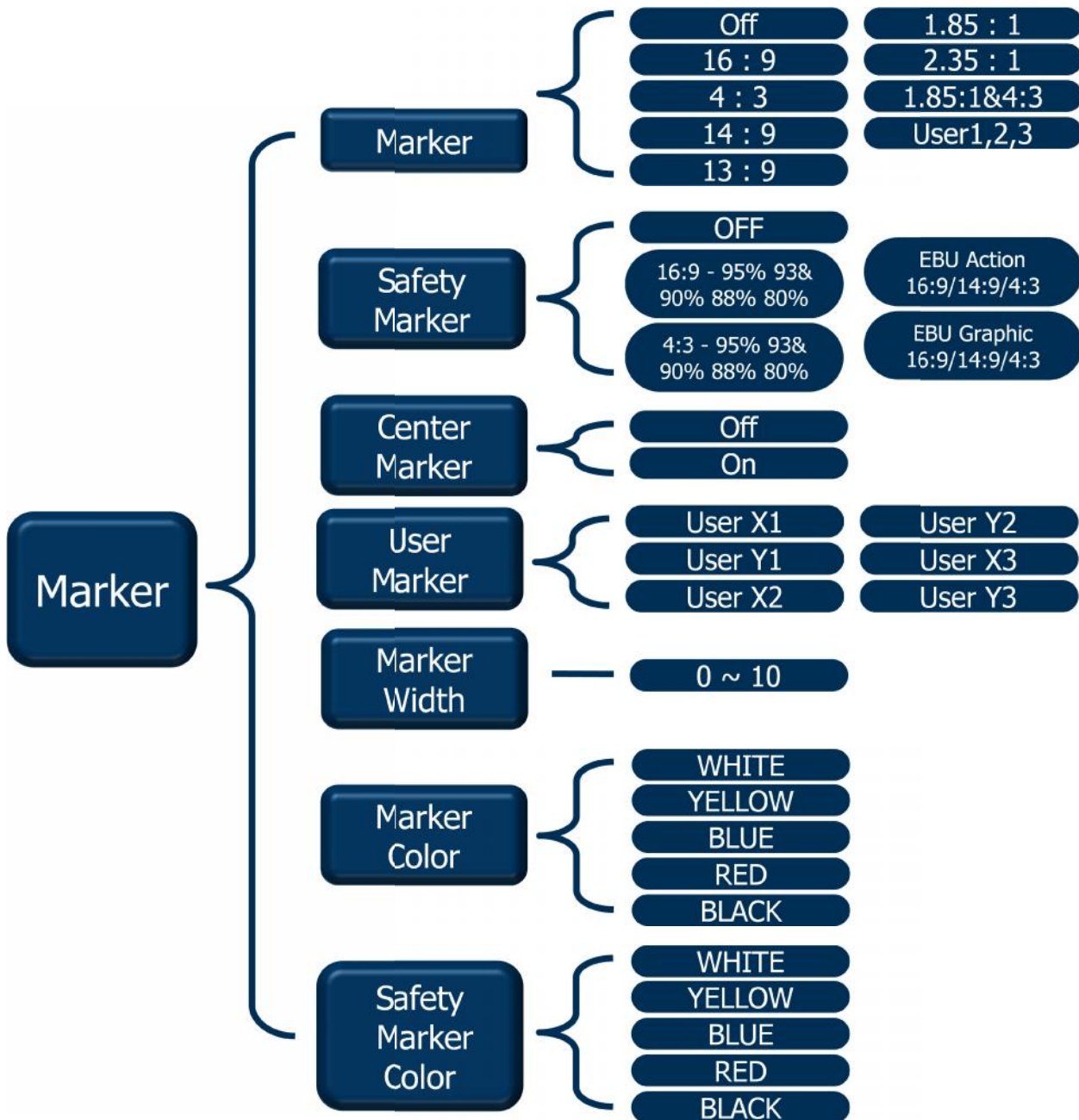

4) **System**

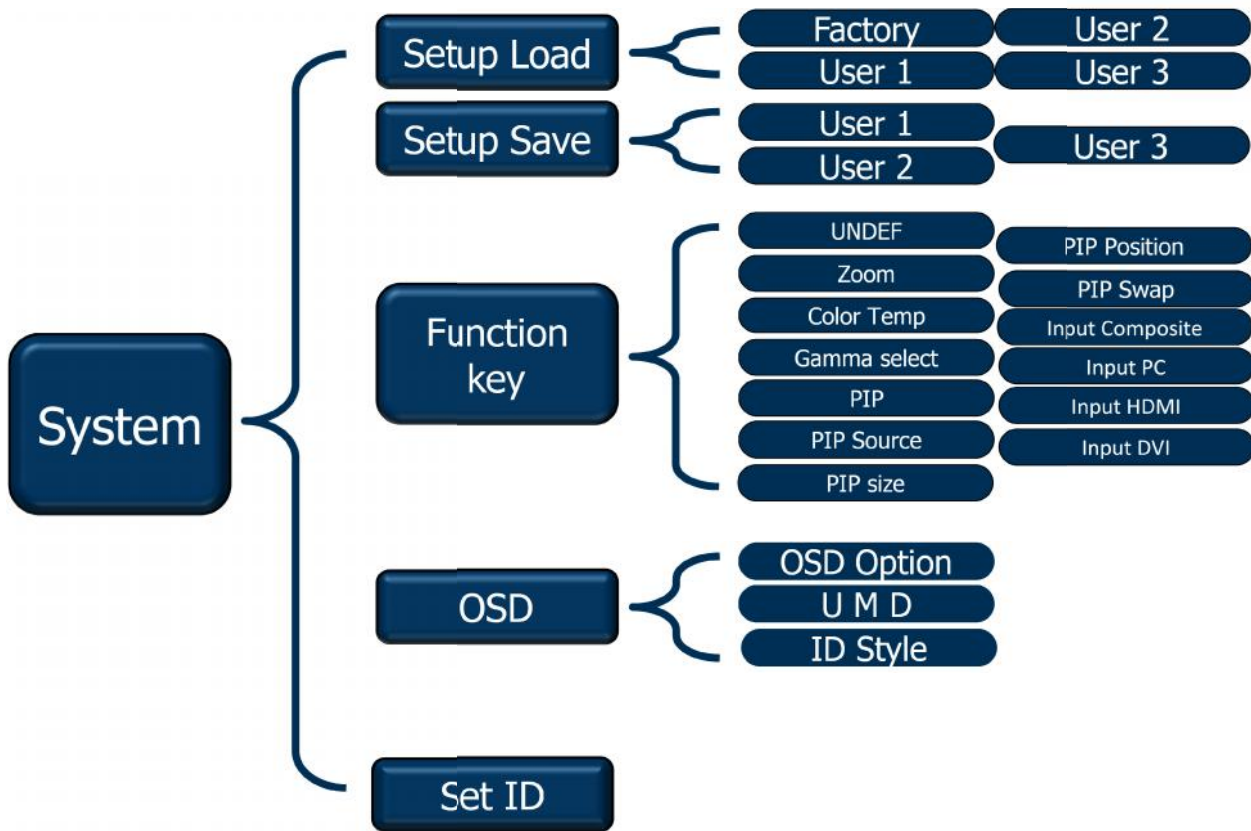

5) **Advanced**

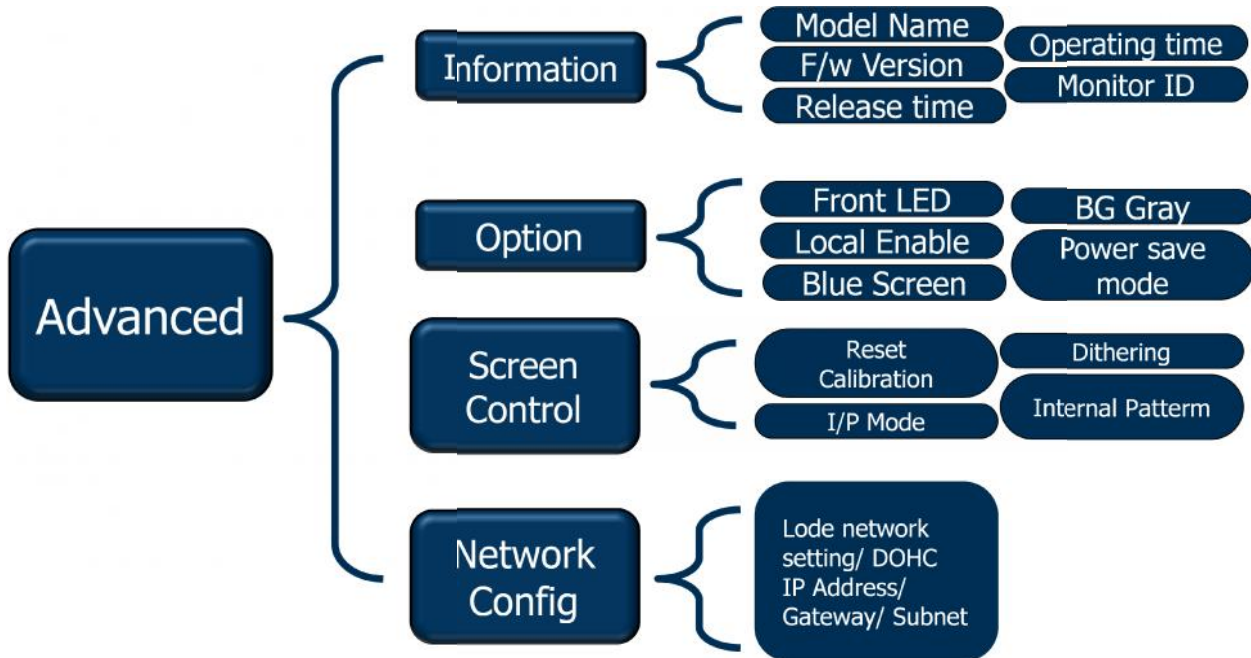

6) *PIP*

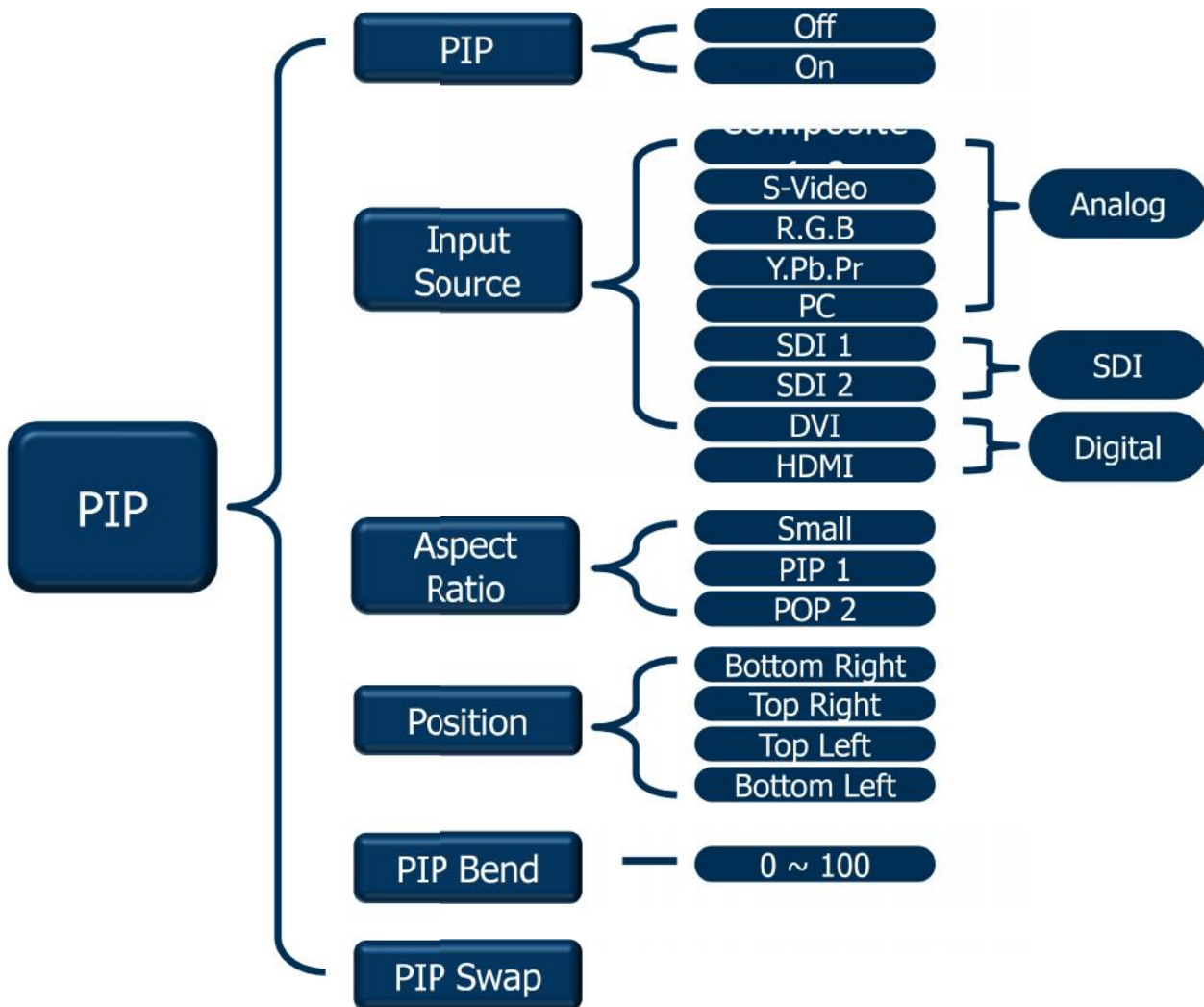

15. SPECIFICATIONS

1) *Panel Specifications*

Model		Specifications
LCM-307-3G	Panel	TFT LCD Panel 2 x 7 inch
	Resolution	1024(H) × 600(V) (Contrast 700:1)
	Brightness	350 cd/m2
	Viewing Angle	R/L: 140 (Typ), U/D 140 (Typ)
LCM-209-3G	Panel	TFT LCD Panel 2 x 9 inch
	Resolution	800(H) × 480(V) (Contrast 700:1)
	Brightness	350 cd/m2
	Viewing Angle	R/L: 140 (Typ), U/D 140 (Typ)
LCM-119-3G	Panel	TFT LCD Panel 19 inch
	Resolution	1366(H) × 768(V) (Contrast 700:1)
	Brightness	300 cd/m2
	Viewing Angle	R/L: 178 (Typ), U/D 178 (Typ)
LCM-123-3G	Panel	TFT LCD Panel 23 inch
	Resolution	1920(H) x 1080(V) (Contrast 1000:1)
	Brightness	300 cd/m2
	Viewing Angle	R/L: 178 (Typ), U/D 178 (Typ)
LCM-132-3G	Panel	TFT LCD Panel 32 inch

	Resolution	1920(H) X 1080(V) (Contrast 1000:1)
	Brightness	300 cd/m2
	Viewing Angle	R/L: 178 (Typ), U/D 178 (Typ)
LCM-147-3G	Panel	TFT LCD Panel 47 inch
	Resolution	1920(H) X 1080(V) (Contrast 4000:1)
	Brightness	450 cd/m2
	Viewing Angle	R/L: 178 (Typ), U/D 178 (Typ)

2) **Supported Signals**

Supported Signals	Serial Digital Interface	SMPTE-425M 1920x1080P(50/60)
		SMPTE-274M 1920x1080i (50/60), 1920x1080P(24/25/30)
		SMPTE-296M 1280x720P (50/59.94/60)
		SMPTE-125M(480i/59.94), ITU-R BT601(576i/50)
	HDMI DVI-D	H Frequency Range : 20~82 kHz
		V Frequency Range : 55 ~ 90 Hz
		Maximum resolution : 1920x1080 60Hz
		Maximum pixel rate : 162 MHz
		DTV mode support : 720P, 1080i, 1080p
	ANALOG RGB	H Frequency Range : 20~82 kHz

		V Frequency Range : 55 ~ 90 Hz
		Maximum resolution : 1920x1080 60Hz
		Maximum pixel rate : 162 MHz
		DTV mode support: 720P/1080i/1080p
	ANALOG Component (DTV/DVD) CVBS	SOG sync support
		1080p
		1080i
		720P
		480i / 576i
		480P / 576P
NTSC/PAL/SECAM		

3) **Supported Timings**

PC & DVI input

Section	Resolution	H Frequency (kHz)	V Frequency (Hz)	Pixel Frequency (MHz)	Comment
PC	640x400	37.861	85.08	31.5	
	640x350	31.469	70.087	25.175	
	640x350	37.861	85.08	31.5	
	640x480	31.469	59.94	25.175	
	640x480	35.000	66.667	30.24	

	640x480	34.940	69.884	28.513	
	640x480	37.861	72.809	29.765	
	640x480	37.500	75.0	31.5	
	640x480	43.269	85.008	36.0	
	640x480	45.540	90.0	37.889	
	720x400	31.469	70.087	28.322	
	720x400	37.927	85.039	35.5	
	800x600	35.156	56.25	36.0	
	800x600	37.879	60.317	40.0	
	800x600	43.764	70.02	45.513	
	800x600	48.077	72.188	50.0	
	800x600	46.875	75.0	49.5	
	800x600	53.674	85.061	56.25	
	800x600	56.880	90.0	60.065	
	832x624	49.726	74.551	57.284	
	1024x768	48.780	60.001	64.11	
	1024x768	48.363	60.004	65.0	
	1024x768	56.476	70.069	75.0	
	1024x768	57.703	72.039	78.476	
	1024x768	60.241	74.927	81.724	
	1024x768	60.030	75.029	78.75	
	1024x768	68.677	84.997	94.5	

	1024x768	72.810	90.0	100.187	
	1152x864	53.700	60.0	81.624	
	1152x864	62.932	69.924	96.663	
	1152x864	67.500	75.0	104.993	
	1152x870	68.681	75.062	100.0	
	1152x900	61.846	66.0	94.787	
	1152x900	72.713	76.047	105.561	
	1280x720	47.760	60.0	74.481	
	1280x720	52.500	70.0	89.040	
	1280x720	54.072	72.0	91.706	
	1280x720	56.400	75.0	95.654	
	1280x768	60.150	75.0	102.977	
	1280x960	60.000	60.0	102.104	
	1280x960	59.640	60.0	102.104	
	1280x1024	63.337	59.978	108.18	
	1280x1024	63.981	60.02	108.0	
	1280x1024	64.754	60.06	108.992	
	1280x1024	63.600	60.0	108.883	
	1360x768	47.700	60.0	84.700	
	1600x1200	75.000	60.0	162.000	
DTV	720x480	15.735	59.94	13.500	Interlaced
	720x576	15.735	50.0	13.595	Interlaced

	720x480	31.469	59.94	25.175	
	720x576	31.250	50.0	26.566	
	1280x720	44.964	59.94	74.176	
	1280x720	37.500	50.0	60.466	
	1920x1080	33.750	60.0	74.25	Interlaced
	1920x1080	28.125	50.0	70.723	Interlaced
	1920x1080	31.250	50.0	72.000	Interlaced
	1920x1080	67.5	60	148.5	Progressive

16. MECHANICAL DIMENSIONS

- LCM-207-3G & LCM-307-3G
*AutoCad.dwg available upon request

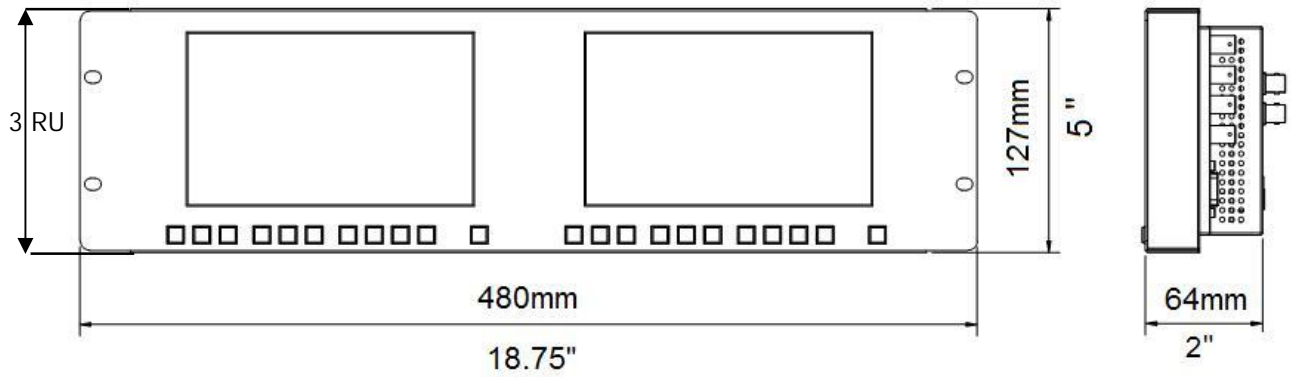

- LCM-209-3G
*AutoCad.dwg available upon request

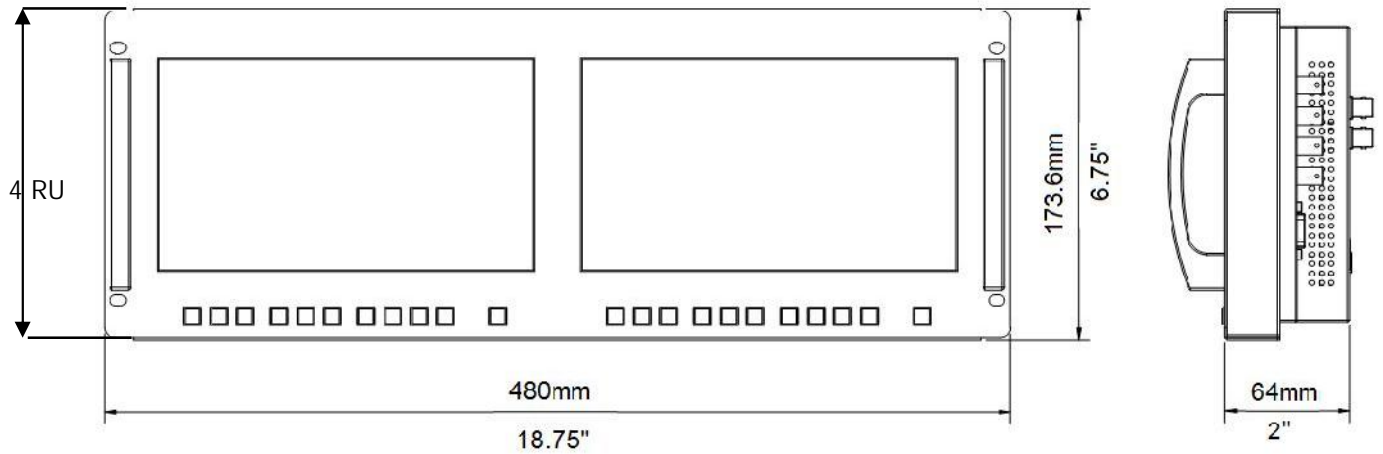

- LCM-119-3G
*AutoCad.dwg available upon request

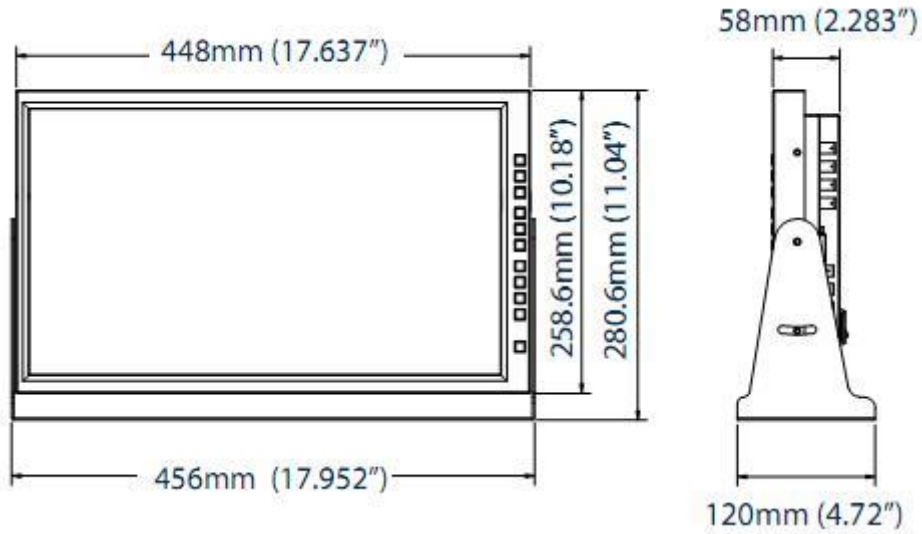

- LCM-123-3G
*AutoCad.dwg available upon request

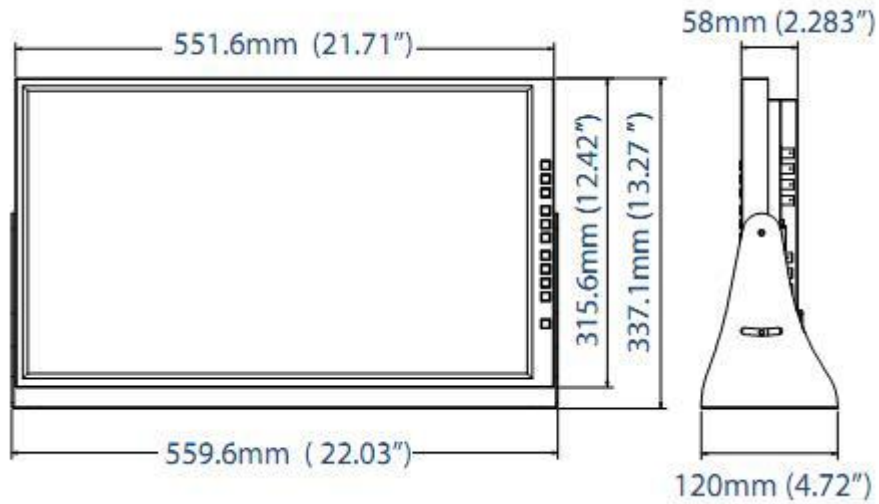

- LCM-132-3G
*AutoCad.dwg available upon request

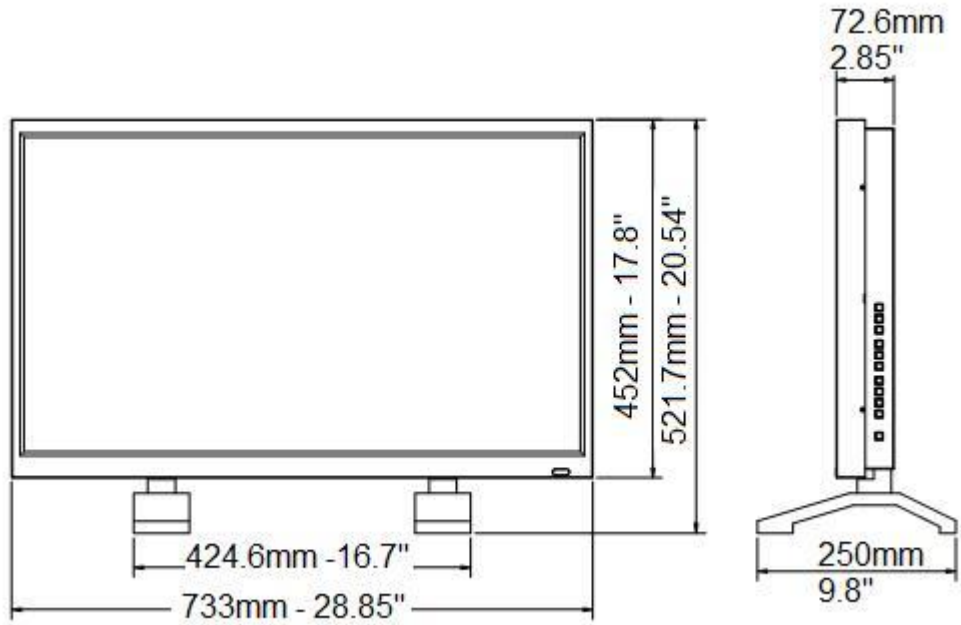

- LCM-147-3G
*AutoCad.dwg available upon request

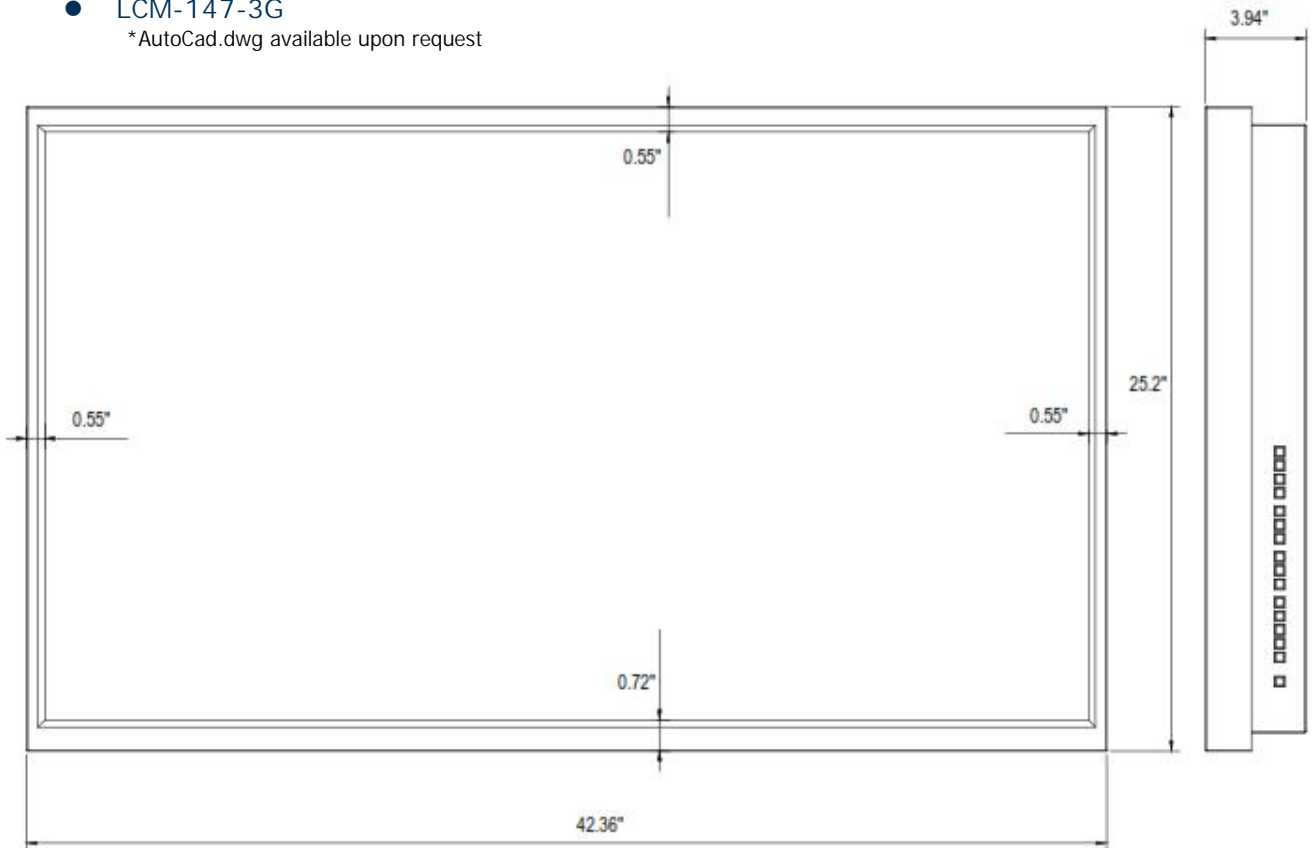

plura®

www.plurainc.com

U.S.A. . Germany . U.A.E. . S.Korea