

Universal Three Input TPS (HDBaseT™) Transmitter with Built in Event Manager



Part No: 9154 0009



Highlight Features

- 4K/UHD (30Hz RGB 4:4:4, 60Hz YCbCr 4:2:0) and 3D capabilities
- Extends DVI, HDMI or VGA + Audio + Ethernet + RS-232 + IR + over a single CAT5e-CAT7e cable up to 170 m distance*
- Event Manager
- 10/100 Ethernet extension
- Bi-directional RS-232 and IR
- IR and RS-232 connection supports command injection
- Embeds analog audio

*Depends on cable category and quality

The WP-UMX-TPS-TX130-US is a flagship model in the Lightware TPS (HDBaseT™ Transmitter) product family. The device can transmit universal video, audio and control up to a 170 meter distance over a single CAT cable in dynamically changing environments such as small board rooms and classrooms. The extender was designed to handle digital and analog video and audio signals: VGA, YPrPb, HDMI1.4 and DP 1.1 with analog stereo audio from local inputs or embedded 7.1 HBR audio. Analog signals (both audio and video) are converted into digital formats. The audio and the video signal can be transmitted separately from each other. The unit offers bi-directional and transparent RS232 and Ethernet transmission and unidirectional and transparent IR transmission. The RS232 connection supports command injection. Remote powering is available through a single CAT 5e - CAT 7 cable, but local power supply can also be used. WP-UMX-TPS- TX130-US is compatible with both the HDBaseT™ extenders and matrix switchers.

HDBaseT™ and the HDBaseT Alliance logo are trademarks of the HDBaseT Alliance

Standalone Application

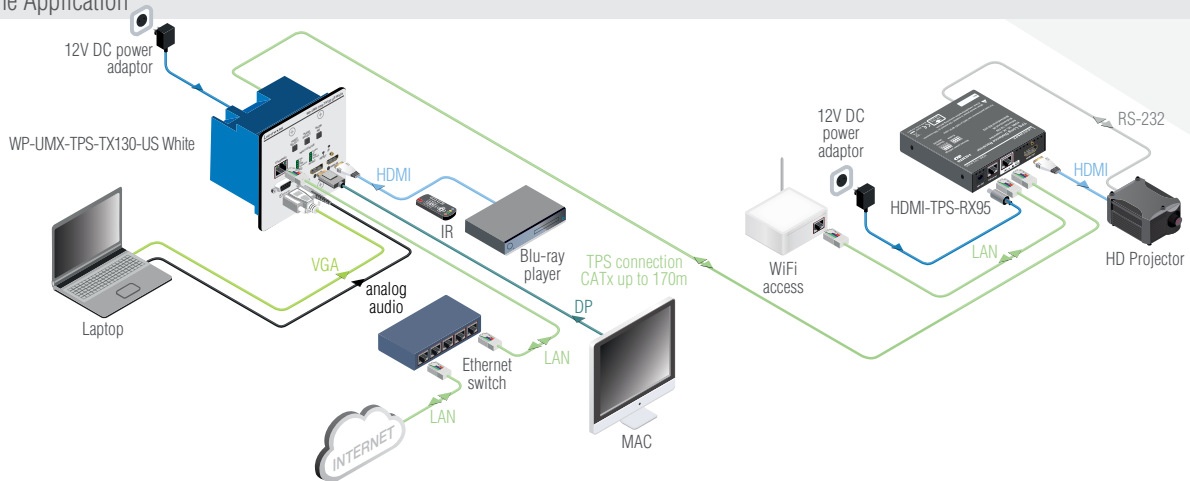

Application Diagram

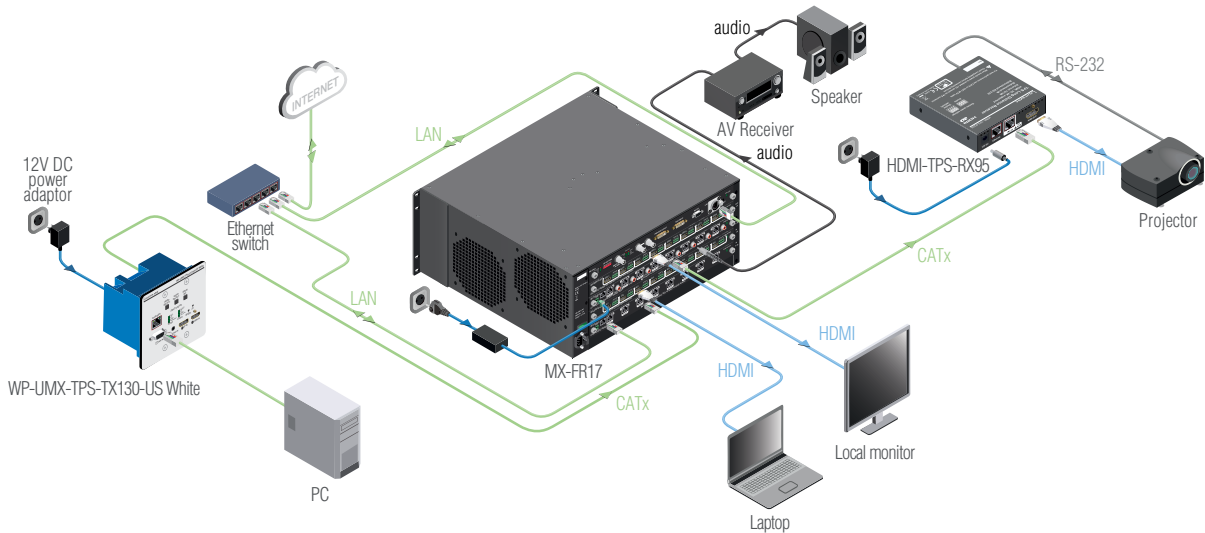

Max Cable Lengths Supported by the Available Firmware Versions

Resolution	Pixel Clock Rate	Cable Lengths (Auto / Longreach TPS mode)		
		CAT5e AWG24	CAT7 AWG26	CAT7 AWG23
1024x768@60Hz	65 MHz	100 m / 130 m*	90 m / 120 m*	120 m / 170 m*
1280x720p@60Hz	73.8 MHz	100 m / 130 m*	90 m / 120 m*	120 m / 170 m*
1920x1080p@60Hz / 24bpp	148.5 MHz	100 m / 130 m*	90 m / 120 m*	120 m / 170 m*
1920x1200@60Hz	152.9 MHz	100 m / NA*	90 m / NA*	120 m / NA*
1600x1200@60Hz	162 MHz	100 m / NA*	90 m / NA*	120 m / NA*
1920x1080@60Hz / 36bpp	223 MHz	70 m / NA*	70 m / NA*	100 m / NA*
3840x2160@30Hz UHD**	297 MHz	70 m / NA*	70 m / NA*	100 m / NA*
4096x2160@30Hz 4K**	297 MHz	70 m / NA*	70 m / NA*	100 m / NA*

Above values are valid when the extender is powered by a local adaptor; distances may decrease depending on the powering mode (local or remote) and cable quality.

* with Long reach operation mode which supports pixel clock frequencies up to 148,5 MHz.

** if 4K video is selected to the output, analog audio cannot be embedded to the video stream due to the capabilities of the video IC, thus the original audio stream is transmitted.

Event Manager

The Event Manager is a completely new feature of Lightware's UMX-TPS extender family. It's available through the Lightware Device Controller and can be configured to detect LW3 protocol CHANGE messages. The Event Manager was developed to handle tasks from the most simple; like displaying internal events on GPIO ports, and controlling the extender via GPIO inputs instead of front panel pushbuttons; to expert ones like controlling the rolling shutter, the air conditioning system or the lights based on any condition changes on the media ports, such as a new source being connected or removed. The Event Manager makes the UMX-TPS extender family an expert solution in a wider range of applications.

Event Manager Wizard

Assigning an action to a condition is quick and easy with the Event Manager's smart Wizard function. The user can choose from the given port options in the dropdown menu and also add expressions to it.

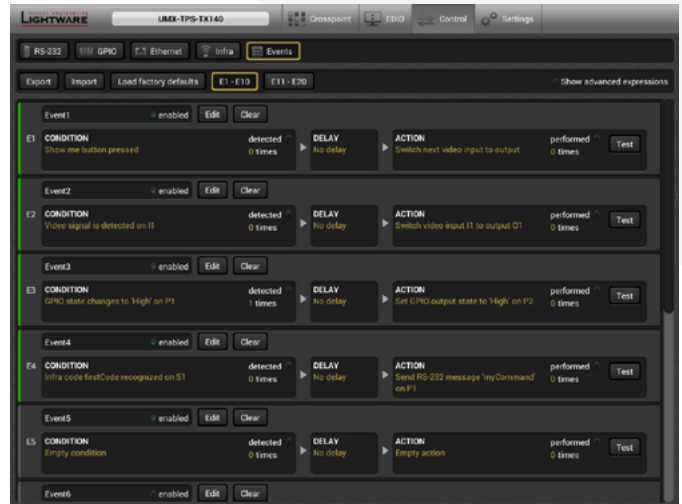

The Events menu contains 20 separately configurable Events

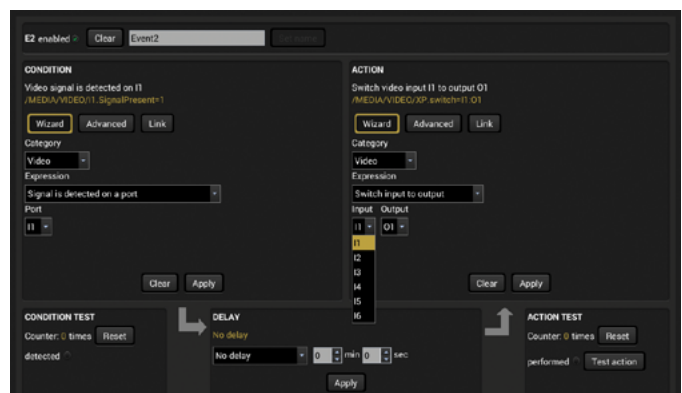

The Event Wizard makes the setup easy with simple dropdown options

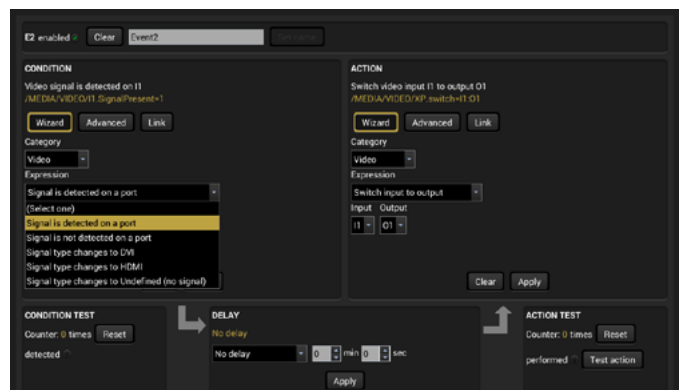

There are many default Expressions available to choose from

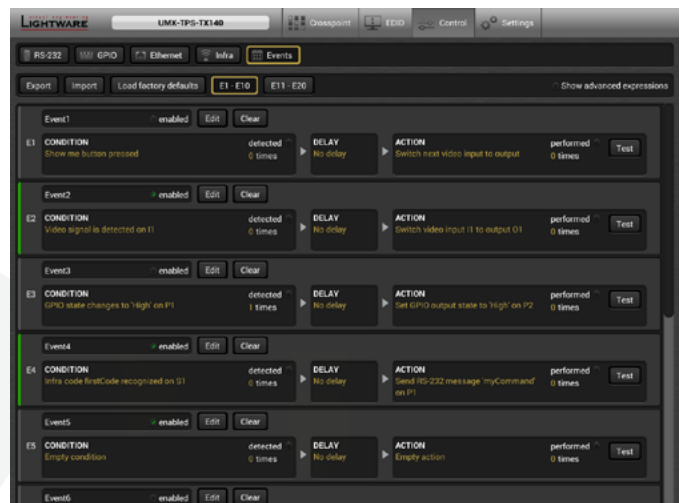

Green lines show which Event is configured and active, the rest stay grey

Event Example A

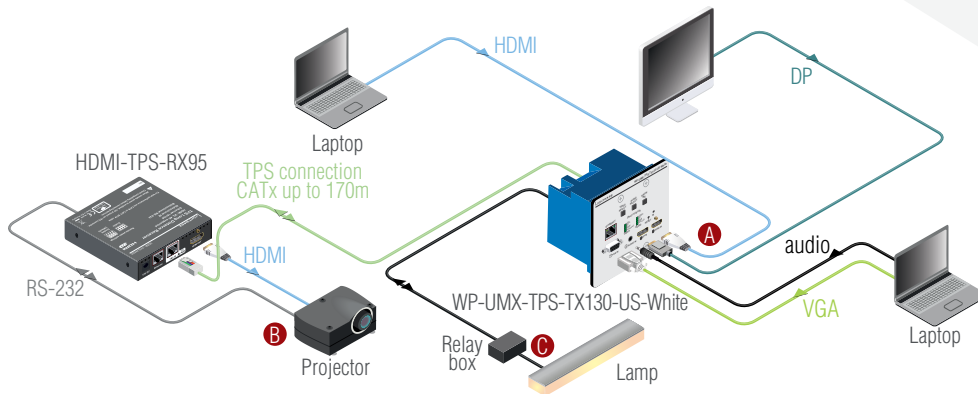

Condition	Action
	A Input select
	B Projector switch on
	C Lamp switch off

With a connected button panel through the GPIO port the UMX-TPS-TX140 can be controlled from a remote location, input switching is available even if the transmitter mounted underdesk. In the example above there are three actions followed by a condition. When an input selector button is pressed on the remote button panel, the input port is switched to the selected one, the lamp switches off, and the projector turns on as well.

Event Example B

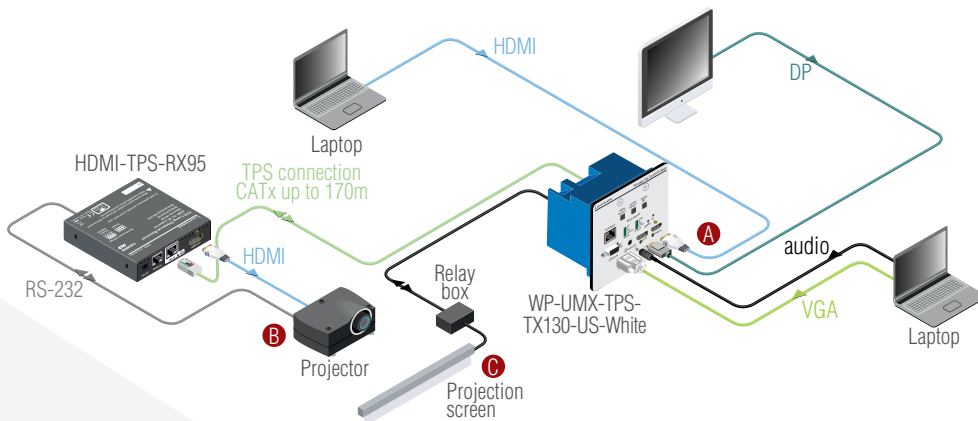



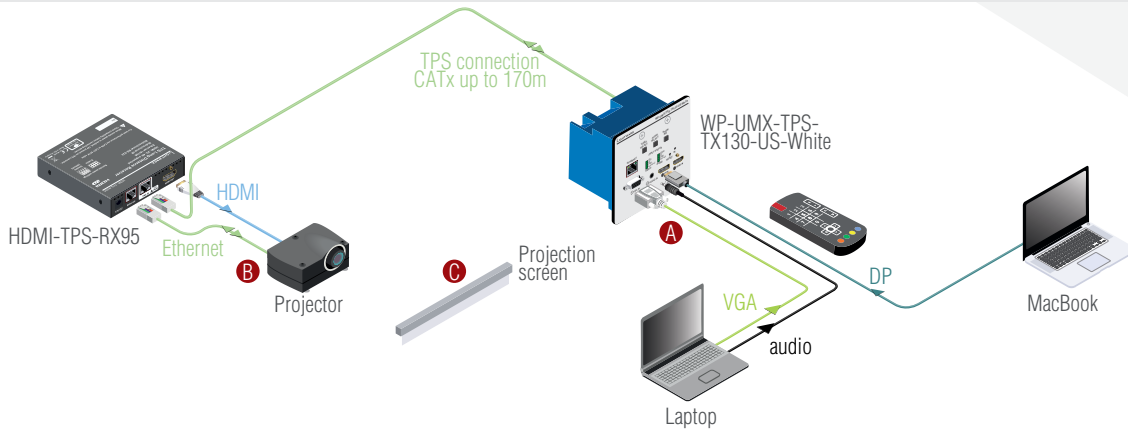

Condition	Action
	A Input select
	B Projector switch on
	C Screen down

The projector and the rolling screen (through the Relay box) are connected to the UMX-TPS-TX140. When the user connects a laptop through HDMI to the transmitter the connected input is selected automatically the screen goes down and the projector turns on to display the connected source.

Event Example C



Condition	Action
	 A Input select
Press remote controller	 B Projector switch on
	 C Screen down

A MacBook with DisplayPort and another laptop with VGA and analog audio are connected to the WP-UMX-TPS-TX130-US wallplate which means there are two audio signals and two video signals connected. With a remote controller via IR these inputs can be switched. For example the analog audio of the Laptop can be mixed with the DisplayPort video of the MacBook. The Event Manager helps the user to assign actions like rolling the screen down and switch the projector on when the desired input is selected.

Powering Options, do not forget to select one of these



PSU-48VP1 Part No: 9134 0011
Universal Wall power adaptor with interchangeable AC plug for international use.

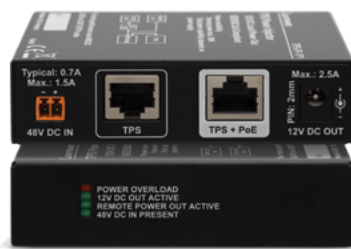

TPS-PI-1P1 Part No: 9134 0010
Single port standalone TPS power injector.

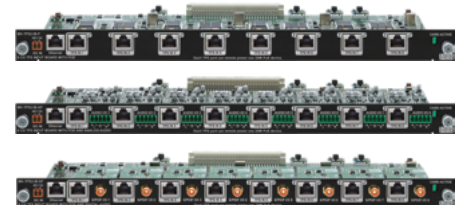

MX-TPS2-IB-P, -AP, -SP
Part No:
9112 0035 (P), 9112 0036 (AP), 9112 0037 (SP)
TPS input board with PoE option.

Applications

- Small classrooms
- Conference rooms, meeting rooms
- Control room
- Home cinema

Features

- 4K/UHD (30Hz RGB 4:4:4, 60Hz YCbCr 4:2:0) and 3D capabilities
- Extends HDMI, VGA or DisplayPort + Audio + Ethernet + RS-232 + IR over a single CAT5e-CAT7e cable up to 170 m distance*
- Audio and video connectors: HDMI, VGA, DisplayPort, Stereo jack
- Embedded 7.1 HBR audio support
- Active cooling system
- Separate audio and video transmission
- Autoselect mode: video and audio priority modes
- Intuitive Control Software
- Event Manager
- 10/100 Ethernet extension
- Bi-directional RS-232 and IR
- IR and RS-232 connection supports command injection
- HDCP compliant, CEC, EDID transparent
- Embeds analog audio
- HDBaseT™ compatibility
- Advanced EDID management
- No signal latency
- Frame detector
- Remote powering through CAT cable

*Depends on cable category and quality

Compatible Products

- MX Modular matrix frames with MX-TPS-IB or MX-TPS2-IB
- HDMI-TPS-RX90
- HDMI-TPS-RX95
- DVI-HDCP-TPS-RX95
- TPS-PI-1P1

Dismounted Diagram:

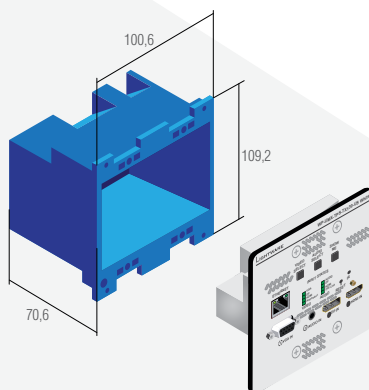

Product name:	2-gang; B225R
Dimensions:	100,6 W x 109,2 H x 70,6 D
Weight:	100 g

Back and Side Views



Specifications

Resolution:	Up to 4K UHD 3840x2160@30Hz, 1600x1200@60Hz, FullHD 1920x1080@60Hz, 1080p@120 Hz
Digital audio formats:	Supports up to 8 channel PCM, Dolby TrueHD and DTS-HD Master Audio 7.1 formats
Input cable equalization:	Automatic max 20 m
EDID emulation:	Yes, Advanced EDID Management
EDID memory:	119 factory preset, 15 user programmable
VGA to digital conversion:	0 microseconds delay
HDCP pass-through:	Yes
RS-232 pass-through:	Yes, configurable
RS-232 (control option):	4800, 9600, 19200, 38400, 57600, 115200 Baud Rx,Tx (local or through CATx)(default: 57600)
Local power:	2-pole, DC 48V 500mA
Power over TPS:	DC 48V 0.25A
Dimensions:	115,9 W x 114,3 H x 72,5 D
Enclosure:	1mm metal
Weight:	457 g
Power consumption:	8,5W (typ)
Compliance:	CE
Warranty:	3 years

Connectors

Digital video input:	HDMI connector, DisplayPort
Analog video input:	VGA connector
Audio input:	3.5 mm stereo jack
Ethernet:	1 x RJ45
Control:	IR
TPS output:	1 x RJ45
Serial port:	3-pole PHOENIX
Power:	2-pole PHOENIX

Analog Audio Input

Volume:	-96 .. 0 dB
Balance:	0 .. 100%