



## evolution wireless G4 ew 100 G4-ME2/835-S | Combo Set



Versatile wireless systems for those who sing, speak or play instruments with up to 42 MHz tuning bandwidth in a stable UHF range and fast, simultaneous setup of up to 12 linked systems.

Dynamic handheld microphone e 835, robust bodypack transmitter and easy clip-on microphone ME 2-II (omni-directional) with high speech intelligibility for daily use on stage.

### FEATURES

- Engineered for professional live sound: Rugged all-in-one combo wireless system for singers, presenters and moderators.
- Dynamic handheld microphone e 835, robust bodypack transmitter and unobtrusive clip-on microphone ME 2-II (omni-directional) with high speech intelligibility for daily use on stage
- True diversity half-rack receiver in a full-metal housing with intuitive LCD display for full control
- Easy and flexible wireless synchronization between transmitter and receiver via infrared
- Fast frequency allocation for up to 12 receivers via new linking functionality
- Up to 20 compatible channels
- Up to 42 MHz bandwidth with 1680 selectable frequencies, fully tunable in a stable UHF range
- Transmission Range: up to 100 meters / 300 feet
- High RF output power (up to 30 mW) depending on country regulations

### DELIVERY INCLUDES

- EM 100 G4
- SK 100 G4
- SKM 100-S G4
- MMD 835-1
- ME 2
- GA 3
- MZQ 1 microphone clamp
- power supply
- 4 AA batteries
- antennen
- RJ 10
- quick guide
- safety guide
- manufacturer declaration sheet
- frequency supplement sheet



# evolution wireless G4

## ew 100 G4-ME2/835-S | Combo Set

### SPECIFICATIONS

#### EM 100 G4

RF characteristics	
Modulation	Wideband FM
Frequency ranges	A1: 470 - 516 MHz A: 516 - 558 MHz AS: 520 - 558 MHz G: 566 - 608 MHz GB: 606 - 648 MHz B: 626 - 668 MHz C: 734 - 776 MHz D: 780 - 822 MHz E: 823 - 865 MHz JB: 806 - 810 MHz K+: 925 - 937.5 MHz 1G8: 1785 - 1800 MHz
Receiving frequencies	Max. 1680 receiving frequencies, adjustable in 25 kHz steps  20 frequency banks, each with up to 12 factory-preset channels, no intermodulation  1 frequency bank with up to 12 programmable channels
Switching bandwidth	up to 42 MHz
Nominal/peak deviation	$\pm 24$ kHz / $\pm 48$ kHz
Receiver principle	True diversity
Sensitivity (with HDX, peak deviation)	$< 2.5 \mu\text{V}$ for 52 dBA <sub>eff S/N</sub>
Adjacent channel selection	Typically $\geq 65$ dB
Intermodulation attenuation	Typically $\geq 65$ dB
Blocking	$\geq 70$ dB

Squelch	low: 5 dB $\mu$ V middle: 15 dB $\mu$ V high: 25 dB $\mu$ V
Pilot tone squelch	Can be switched off
Antenna inputs	2 BNC sockets

AF characteristics	
Compander system	Sennheiser HDX
EQ presets (switchable, act on line and monitor outputs)	Preset 1: Flat Preset 2: Low Cut (-3 dB at 180 Hz) Preset 3: Low Cut/High Boost (-3 dB at 180 Hz, +6 dB at 10 kHz) Preset 4: High Boost (+6 dB at 10 kHz)
Signal-to-noise ratio (1 mV, peak deviation)	$\geq 110$  dBA
Total harmonic distortion (THD)	$\leq 0.9$  %
AF output voltage (at peak deviation, 1 kHz AF)	6.3 mm jack socket (unbalanced): +12 dBu XLR socket (balanced): +18 dBu
Setting range "AF Out"	48 dB (3 dB steps)
Overall device	
---	---
Temperature range	-10 °C to +55 °C
Power supply	12 V DC
Current consumption	300 mA
Dimensions	Approx. 190 x 212 x 43 mm
Weight	Approx. 980 g

### CONNECTIONS





# evolution wireless G4

## ew 100 G4-ME2/835-S | Combo Set

### SPECIFICATIONS

#### SK 100 G4

RF characteristics	
Modulation	Wideband FM
Frequency ranges	A1: 470 - 516 MHz A: 516 - 558 MHz AS: 520 - 558 MHz G: 566 - 608 MHz GB: 606 - 648 MHz B: 626 - 668 MHz C: 734 - 776 MHz D: 780 - 822 MHz E: 823 - 865 MHz JB: 806 - 810 MHz K+: 925 - 937.5 MHz 1G8: 1785 - 1800 MHz
Transmission frequencies	Max. 1680 receiving frequencies, adjustable in 25 kHz steps  20 frequency banks, each with up to 12 factory-preset channels, no intermodulation  1 frequency bank with up to 12 programmable channels
Switching bandwidth	up to 42 MHz
Nominal/peak deviation	$\pm 24$ kHz / $\pm 48$ kHz
Frequency stability	$\leq \pm 15$ ppm
RF output power at 50 $\Omega$	Max. 30 mW
Pilot tone squelch	Can be switched off

#### AF characteristics

Compander system	Sennheiser HDX
AF frequency response	Mic: 80 - 18,000 Hz Line: 25 - 18,000 Hz
Signal-to-noise ratio (1 mV, peak deviation)	$\geq 110$ dBA
Total harmonic distortion (THD)	$\leq 0.9$ %
Max. microphone/line input voltage	3 V <sub>eff</sub>
Microphone/line input impedance	40 k $\Omega$ , unbalanced / 1 M $\Omega$
Input capacitance	Switchable
Setting range for input sensitivity	60 dB, adjustable in 3 dB steps

#### Overall device

Temperature range	-10 °C to +55 °C
Power supply	2 AA batteries, 1.5 V or BA 2015 accupack
Nominal voltage	3 V battery / 2.4 V rechargeable battery
Current consumption	at nominal voltage: typ. 180 mA with transmitter switched off: $\leq 25$ $\mu$ A
Operating time	Typically 8 h
Dimensions	Approx. 82 x 64 x 24 mm
Weight (incl. batteries)	approx. 160 g

### SPECIFICATIONS

#### ME 2

Transducer principle	pre-polarized condenser microphone
Pick-up pattern	omni-directional
Sensitivity (free field, no load) (1 kHz)	20 mV/Pa
Max. SPL at 1 kHz	130 dB
Frequency response	"50 to 18,000 Hz (ME 2-II) 30 to 20,000 Hz (ME 2-US)"
"Equivalent noise level A-weighted (DIN IEC 651)"	36 dB
Connector	3.5 mm jack
Cable length	approx. 1.60 m
Supply voltage	7.5 V



# evolution wireless G4

## ew 100 G4-ME2/835-S | Combo Set

### SPECIFICATIONS

#### SKM 100 G4-S

RF characteristics	
Modulation	Wideband FM
Frequency ranges	A1: 470 - 516 MHz A: 516 - 558 MHz AS: 520 - 558 MHz G: 566 - 608 MHz GB: 606 - 648 MHz B: 626 - 668 MHz C: 734 - 776 MHz D: 780 - 822 MHz E: 823 - 865 MHz JB: 806 - 810 MHz K+: 925 - 937.5 MHz 1G8: 1785 - 1800 MHz
Transmission frequencies	Max. 1680 receiving frequencies, adjustable in 25 kHz steps  20 frequency banks, each with up to 12 factory-preset channels, no intermodulation  1 frequency bank with up to 12 programmable channels
Switching bandwidth	up to 42 MHz
Nominal/peak deviation	$\pm 24$ kHz / $\pm 48$ kHz
Frequency stability	$\leq \pm 15$ ppm
RF output power at 50 $\Omega$	Max. 30 mW
Pilot tone squelch	Can be switched off

#### AF characteristics

Compander system	Sennheiser HDX
AF frequency response	80 - 18,000 Hz
Signal-to-noise ratio (1 mV, peak deviation)	$\geq 110$ dBA
Total harmonic distortion (THD)	$\leq 0.9$ %
Max. input voltage	3 V <sub>eff</sub>
Input impedance	40 k $\Omega$
Input capacitance	Switchable
Setting range for input sensitivity	48 dB, adjustable in 6 dB steps

#### Overall device

Temperature range	-10 °C to +55 °C
Power supply	2 AA batteries, 1.5 V or BA 2015 accupack
Nominal voltage	3 V battery / 2.4 V rechargeable battery
Current consumption	at nominal voltage: typ. 180 mA with transmitter switched off: $\leq 25$ $\mu$ A
Operating time	Typically 8 h
Dimensions	Approx. $\varnothing$ 50 x 265 mm
Weight (incl. batteries)	approx. 450 g

### SPECIFICATIONS

#### MMD 835-1

Transducer principle	dynamic
Sensitivity	2.1 mV/Pa
Sound pressure level	154 dB SPL
Pick-up pattern	cardioid



# evolution wireless G4

## ew 100 G4-ME2/835-S | Combo Set

### PRODUCT VARIANTS

#### Made in Germany

<b>ew 100 G4-ME2-835-S-A1</b>	470 - 516 MHz	Art. no. 507577
<b>ew 100 G4-ME2-835-S-A</b>	516 - 558 MHz	Art. no. 507578
<b>ew 100 G4-ME2-835-S-GB</b>	606 - 648 MHz	Art. no. 507579
<b>ew 100 G4-ME2-835-S-G</b>	566 - 608 MHz	Art. no. 507580
<b>ew 100 G4-ME2-835-S-B</b>	626 - 668 MHz	Art. no. 507581
<b>ew 100 G4-ME2-835-S-C</b>	734 - 776 MHz	Art. no. 507582
<b>ew 100 G4-ME2-835-S-E</b>	823 - 865 MHz	Art. no. 507583
<b>ew 100 G4-ME2-835-S-1G8</b>	1785 - 1800 MHz	Art. no. 507584

#### Assembled in USA

<b>ew 100 G4-ME2-835-A1</b>	470 - 516 MHz	Art. no. 507922
<b>ew 100 G4-ME2-835-A</b>	516 - 558 MHz	Art. no. 507923
<b>ew 100 G4-ME2-835-AS</b>	520 - 558 MHz	Art. no. 507924
<b>ew 100 G4-ME2-835-G</b>	566 - 608 MHz	Art. no. 507925
<b>ew 100 G4-ME2-835-B</b>	626 - 668 MHz	Art. no. 507926
<b>ew 100 G4-ME2-835-C</b>	734 - 776 MHz	Art. no. 507927
<b>ew 100 G4-ME2-835-D</b>	780 - 822 MHz	Art. no. 507928



# evolution wireless G4

## ew 100 G4-ME2/835-S | Combo Set

### DIMENSIONS

#### EM 100 G4

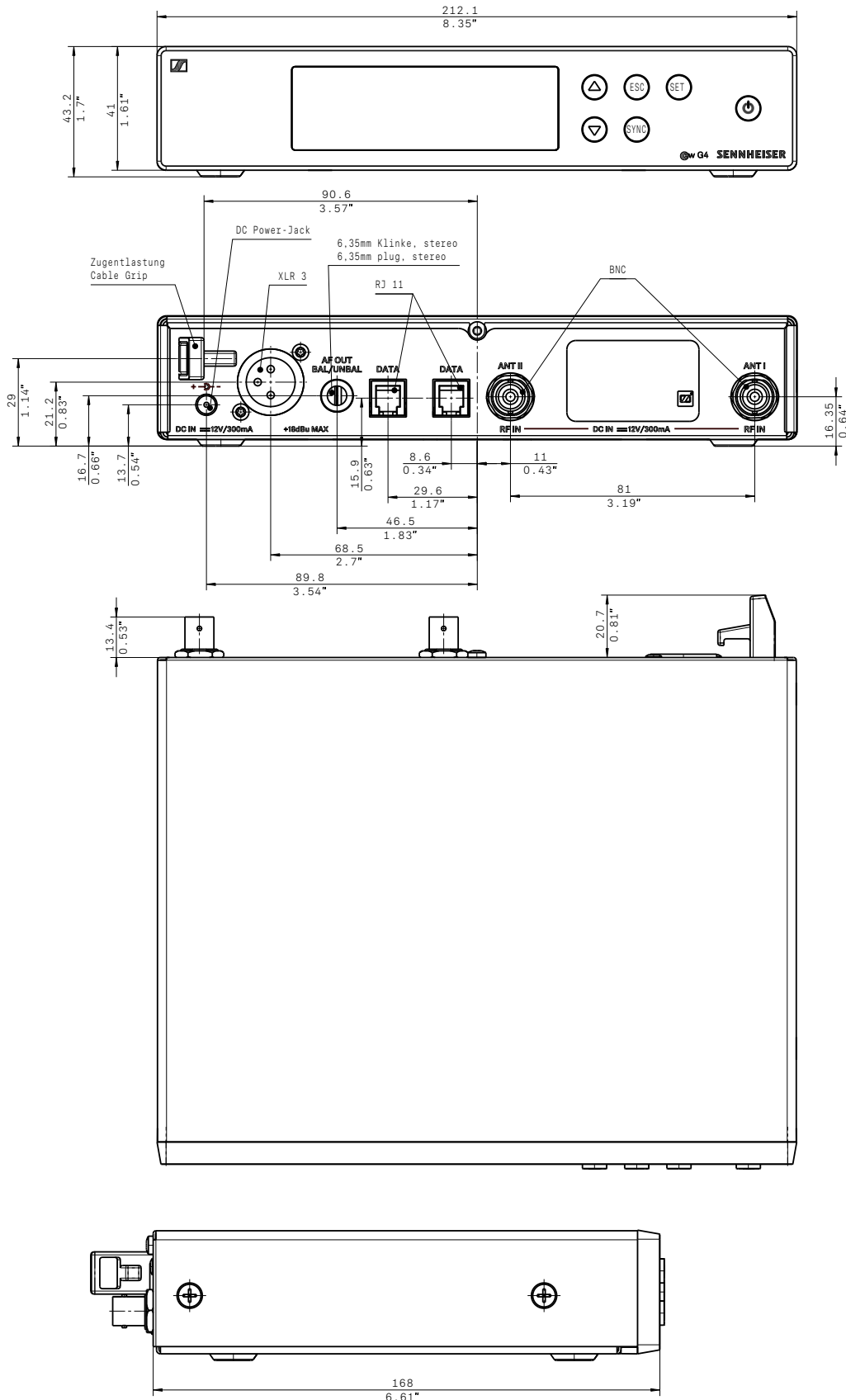



# evolution wireless G4

## ew 100 G4-ME2/835-S | Combo Set

### DIMENSIONS

#### SK 100 G4

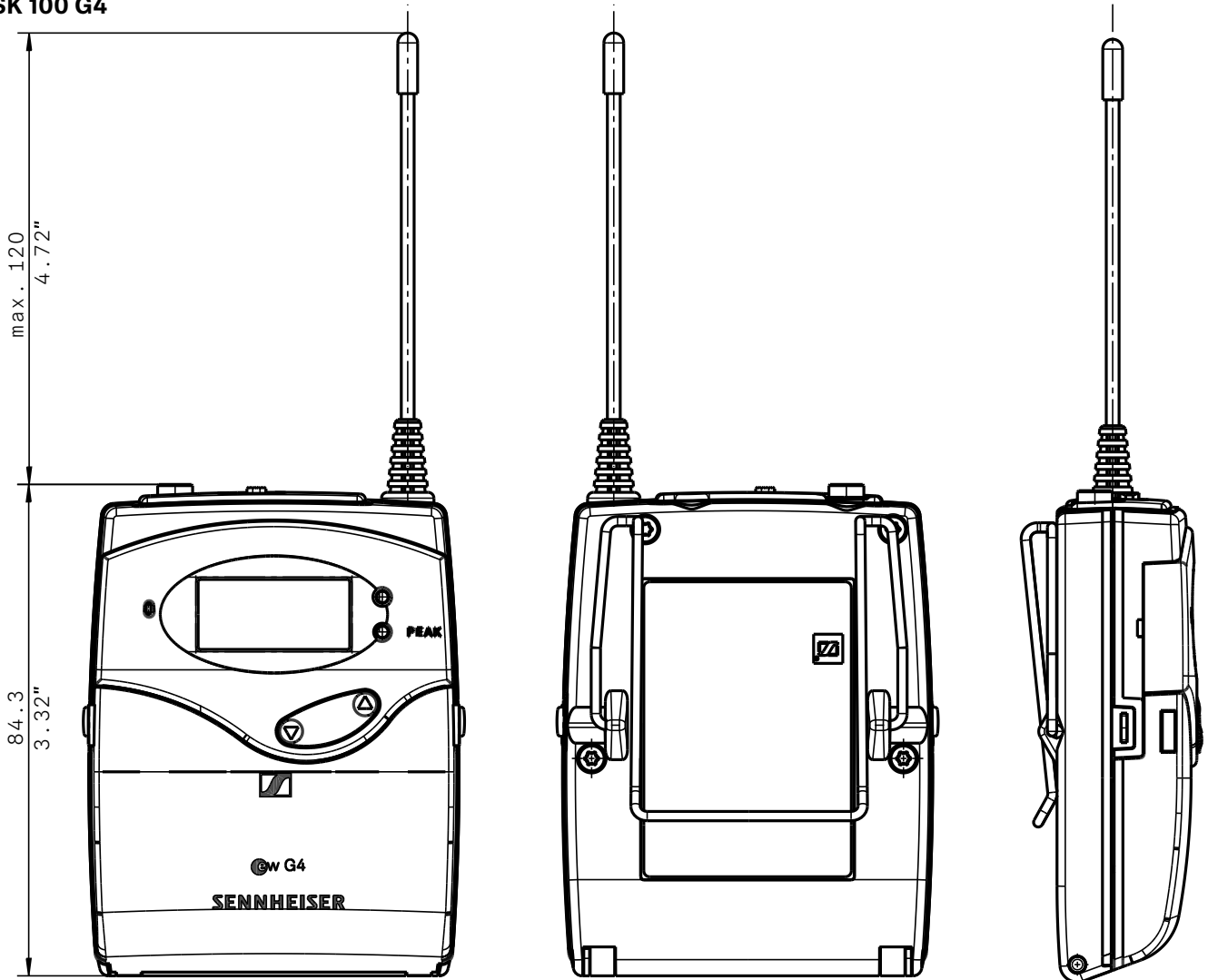

3,5mm Klinke  
3,5mm plug

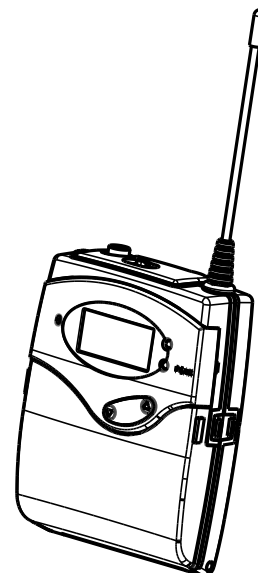
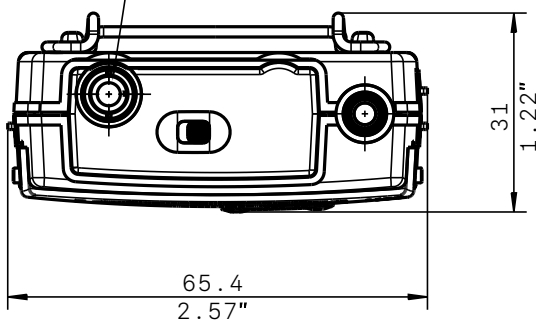



# evolution wireless G4

## ew 100 G4-ME2/835-S | Combo Set

### DIMENSIONS

#### SKM 100 G4-S

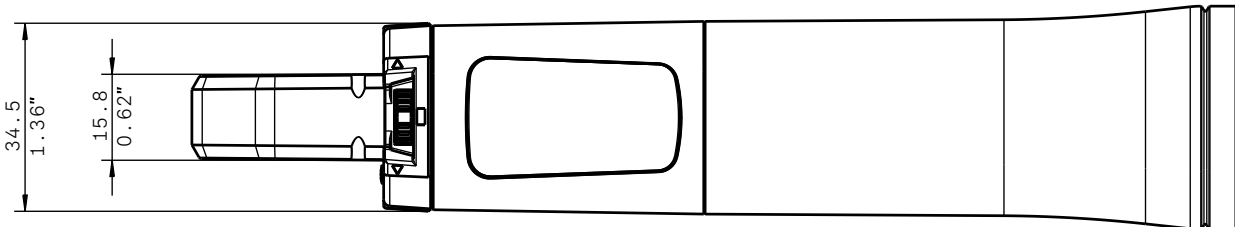
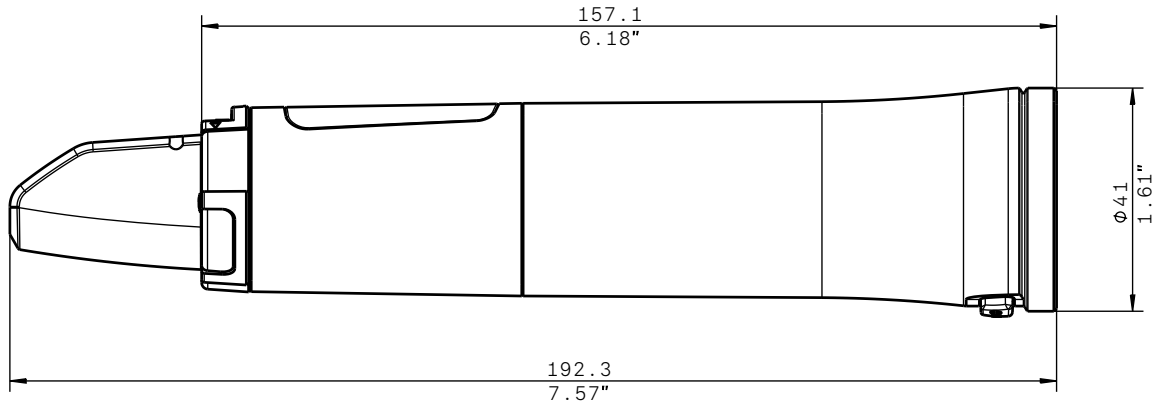
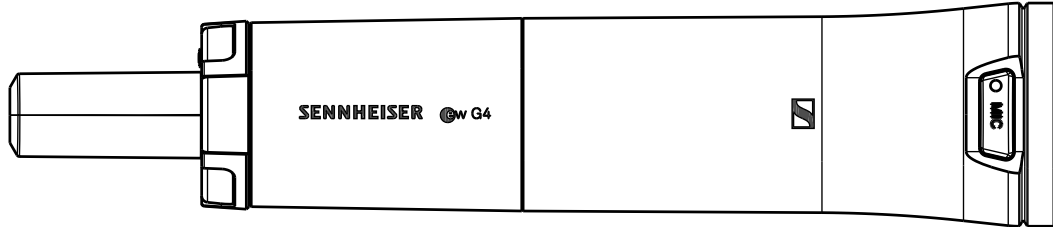





# evolution wireless G4

## ew 100 G4-ME2/835-S | Combo Set

### ARCHITECT'S SPECIFICATION

A wireless RF transmission system consisting of a stationary receiver, a bodypack transmitter with a clip-on microphone and a radio microphone with a cardioid dynamic microphone head.

The system shall operate within twelve UHF frequency ranges, with a switching bandwidth of up to 42 MHz: 470 – 516 MHz, 516 – 558 MHz, 520 – 558 MHz, 566 – 608 MHz, 606 – 648 MHz, 626 – 668 MHz, 734 – 776 MHz, 780 – 822 MHz, 823 – 865 MHz, 806 – 810 MHz, 925 – 937.5 MHz, 1785 – 1800 MHz; receiving frequencies shall be 1,680 per range and shall be tunable in 25 kHz steps. The system shall feature 20 fixed frequency banks with up to 12 compatible frequency presets and 1 user bank with up to 12 user programmable frequencies.

The receiver shall be menu-driven with a backlit LC display showing the current frequency, frequency bank and channel number, metering of RF level, metering of AF level, lock status, pilot tone evaluation, muting function, and battery status of the associated transmitter. An auto-lock feature shall be provided to prevent settings from being accidentally altered. The receiver shall feature an integrated guitar tuner and shall provide a sound check mode.

Some receiver parameters such as receiving frequency, receiver name and pilot tone setting shall be synchronizable with the associated transmitter via an integrated infrared interface.

The receiver shall feature a balanced XLR-3M audio output with a maximum output of +18 dBu along with an unbalanced ¼" (6.3 mm) audio output with a maximum output of +12 dBu. The receiver shall have two DATA ports (RJ 10) to set up a multichannel system. Two BNC-type input sockets shall be provided for connecting the antennas.

Nominal/peak deviation shall be  $\pm 24$  kHz/ $\pm 48$  kHz. Squelch threshold shall be adjustable to three levels: Low (5 dB $\mu$ V), Middle (15 dB $\mu$ V) and High (25 dB $\mu$ V).

The receiver shall incorporate the Sennheiser HDX compander system and a defeatable pilot tone squelch. Sensitivity shall be  $< 2$   $\mu$ V for 52 dBA eff S/N with HDX engaged at peak deviation. Adjacent channel rejection shall be  $\geq 65$  dB (typical). Intermodulation attenuation shall be  $\geq 65$  dB (typical); blocking shall be  $\geq 70$  dB. Four selectable equalizer presets shall be provided: "Flat", "Low Cut" ( $-3$  dB at 180 Hz), "Low Cut/High Boost" ( $-3$  dB at 180 Hz/ $+6$  dB at 10 kHz) and "High Boost" ( $+6$  dB at 10 kHz).

Signal-to-noise ratio at 1 mV and peak deviation shall be  $\geq 110$  dBA. Total harmonic distortion (THD) shall be  $\leq 0.9$  %. The audio output level shall be adjustable within a 48 dB range in steps of 3 dB.

The receiver shall operate on 12 V power supplied from the NT 2-3 CW mains unit (for 100 – 240 V AC, 50/60 Hz). Power consumption shall be 300 mA. The receiver shall have a rugged metal housing; dimensions shall be approximately 190 x 212 x 43 mm (7.48" x 8.35" x 1.69"). Weight shall be approximately 980 grams (2.16 lbs). Operating temperature shall range from  $-10$  °C to  $+55$  °C ( $+14$  °F to  $+131$  °F).

The receiver shall be the Sennheiser EM 100 G4.

The bodypack transmitter shall be menu-driven with a backlit LC display showing the current frequency, frequency bank and channel number, metering of AF level, transmission status, lock status, pilot tone transmission, muting function, and battery status. An auto-lock feature shall be provided to prevent settings from being accidentally altered.

The transmitter parameters shall either be configurable in the associated receiver's menu and synchronized with the transmitter via an integrated infrared interface or shall be programmable in the transmitter menu.

The transmitter shall be equipped with a mute switch, which shall be switchable between "AF on/off", "RF on/off" and "Disabled" via the user interface.

Nominal/peak deviation shall be  $\pm 24$  kHz/ $\pm 48$  kHz. Frequency stability shall be  $\leq \pm 15$  ppm. RF output power at 50  $\Omega$  shall be 30 mW (typical).

The transmitter shall incorporate the Sennheiser HDX compander system and a defeatable pilot tone squelch. Audio frequency response shall range from 80 – 18,000 Hz (microphone) or 25 – 18,000 Hz (line). Signal-to-noise ratio at 1 mV and peak deviation shall be  $\geq 110$  dBA. Total harmonic distortion (THD) shall be  $\leq 0.9$  %. Input sensitivity shall be adjustable within a 60 dB range in steps of 3 dB.

Power shall be supplied to the transmitter by two 1.5 V AA size batteries or by one Sennheiser BA 2015 rechargeable accupack. Nominal voltage shall be 2.4 V for a rechargeable battery or 3 V for a battery, current consumption shall be typical 180 mA at nominal voltage;  $\leq 25$   $\mu$ A when transmitter is switched off. Operating time shall be typical 8 hours. The transmitter shall have a rugged metal housing; dimensions shall be approximately 82 x 64 x 24 mm (3.23" x 2.52" x 0.94"). Weight including the batteries shall be approximately 160 grams (0.35 lbs). Operating temperature shall range from  $-10$  °C to  $+55$  °C ( $+14$  °F to  $+131$  °F).

The bodypack transmitter shall be the Sennheiser SK 100 G4.



## evolution wireless G4 ew 100 G4-ME2/835-S | Combo Set

The radio microphone shall be menu-driven with a backlit LC display showing the current frequency, frequency bank and channel number, metering of AF level, transmission status, lock status, pilot tone transmission, muting function, and battery status. An auto-lock feature shall be provided to prevent settings from being accidentally altered.

The radio microphone parameters shall either be configurable in the associated receiver's menu and synchronized with the radio microphone via an integrated infrared interface or shall be programmable in the radio microphone menu. Receiver parameters such as receiving frequency, receiver name and pilot tone setting shall be synchronizable with the radio microphone via an integrated infrared interface.

The handheld vocal radio microphone shall be equipped with a mute switch, which shall be switchable between "AF on/off", "RF on/off" and "Disabled" via the user interface.

Nominal/peak deviation shall be  $\pm 24$  kHz/ $\pm 48$  kHz. Frequency stability shall be  $\leq \pm 15$  ppm. RF output power at 50  $\Omega$  shall be 30 mW (typical).

The radio microphone shall incorporate the Sennheiser HDX compander system and a defeatable pilot tone squelch. Audio frequency response shall range from 80 – 18,000 Hz. Signal-to-noise ratio at 1 mV and peak deviation shall be  $\geq 110$  dBA. Total harmonic distortion (THD) shall be  $\leq 0.9$  %. Input sensitivity shall be adjustable within a 48 dB range in steps of 6 dB.

Power shall be supplied to the radio microphone by two 1.5 V AA size batteries or by one Sennheiser BA 2015 rechargeable accupack. Nominal voltage shall be 2.4 V, current consumption shall be typical 180 mA at nominal voltage;  $\leq 25$   $\mu$ A when radio microphone is switched off. Operating time shall be typical 8 hours. The radio microphone shall have a rugged metal housing; dimensions shall be approximately 50 mm (1.97") in diameter and 265 mm (10.43") in length. Weight including the batteries shall be approximately 450 grams (0.99 lbs). Operating temperature shall range from  $-10$  °C to  $+55$  °C ( $+14$  °F to  $+131$  °F).

A range of microphone heads shall be available for the radio microphone.

The radio microphone shall be the Sennheiser SKM 100-S G4.