



# Operating Instructions

SFP-H & SFP-H-7 “Hybrid” Series



SFP-H & SFP-H-7 Series

SFP-317-H / 317-H-7

SFP-321-H / 321-H-7

SFP-324-H / 324-H-7

SFP-332-H / 332-H-7

SFP-347-H / 347-H-7

SFP-355-H / 355-H-7

SFP-365-H / 365-H-7

SFP-384-H / 384-H-7

<b>PRECAUTION</b> -----	<b>6</b>
<b>1. OVERVIEW</b> -----	<b>9</b>
<b>2. GENERAL FEATURES</b> -----	<b>9</b>
<b>3. FUNCTIONS AND I/O DESCRIPTIONS</b> -----	<b>10</b>
1) FRONT -----	10
● <i>SFP-317-H</i> -----	10
● <i>Front Keypad</i> -----	10
● <i>Front Keypad Operations</i> -----	11
● <i>SFP Modules Information</i> -----	12
● <i>Front panel LED Operations</i> -----	12
● <i>Speaker Out</i> -----	12
2) REAR-----	13
● <i>I/O Details</i> -----	13
● <i>Power IN – AC &amp; DC</i> -----	13
● <i>PIPM-R-7 OPTION</i> -----	14
● <i>PIPM-R-7 Connectivity</i> -----	14
● <i>PIPM-R-7 configuration page</i> -----	14
● <i>RJ-45 Connections</i> -----	17
● <i>I/O Description</i> -----	17
<b>4. MENU OVERVIEW</b> -----	<b>18</b>
● <i>To display / hide the Menu</i> -----	18
● <i>To go to the next level</i> -----	18
● <i>To go back to the previous level</i> -----	18
● <i>Typical Menu Operation</i> -----	18
<b>5. BASIC OPERATION</b> -----	<b>19</b>
● <i>Turning ON &amp; OFF the Monitor</i> -----	19
● <i>Volume Adjustment</i> -----	19
● <i>On Screen Menu Language Selection</i> -----	19
<b>6. ON SCREEN MENUS SELECTION AND ADJUSTMENT</b> -----	<b>20</b>
● <i>How to adjust the OSD screen</i> -----	20
<b>7. SELECT VIDEO INPUT</b> -----	<b>20</b>

●	<i>How to Select Video Source by OSD</i>	20
<b>8.</b>	<b>MENU OPTIONS FOR DIFFERENT I/P SOURCES</b>	<b>21</b>
●	<i>Menu of different Input source</i>	21
●	<i>Adjust</i>	22
●	<i>Color Temperature Control</i>	22
●	<i>SCAN</i>	22
●	<i>Aspect Ratio</i>	23
●	<i>Zoom</i>	23
●	<i>Mono/Blue Only</i>	24
●	<i>PC Menu (pc mode only)</i>	24
●	<i>Flip</i>	24
●	<i>NR (Noise Reduction)</i>	25
●	<i>SFP Setting</i>	25
<b>9.</b>	<b>AUDIO MENU OPTIONS</b>	<b>26</b>
●	<i>MAIN / SUB Audio out</i>	26
●	<i>SDI Main/ SDI Sub Audio Output Channel</i>	26
●	<i>SDI Main/ SDI Sub Audio Group</i>	26
●	<i>Level Meter</i>	26
●	<i>Level Meter Type</i>	27
●	<i>Level Meter Position</i>	27
●	<i>Level Meter Scale</i>	27
●	<i>Audio Loudness (LKFS)</i>	28
●	<i>Volume</i>	28
●	<i>Lip Sync Delay</i>	28
<b>10.</b>	<b>MARKER MENU OPTIONS</b>	<b>29</b>
●	<i>Marker &amp; User Marker</i>	29
●	<i>Safety Area</i>	29
●	<i>Center Maker</i>	30
●	<i>Marker Width</i>	30
●	<i>Marker Color</i>	30
●	<i>Preset1 &amp; Preset2</i>	30
<b>11.</b>	<b>GPI MENU OPTIONS</b>	<b>31</b>

●	<i>GPI Control &amp; GPI#</i> -----	31
<b>12.</b>	<b>SETUP MENU OPTIONS</b> -----	<b>32</b>
●	<i>Setup Load &amp; Setup Save</i> -----	32
●	<i>Function 1 &amp; Function 2 &amp; Function 3</i> -----	32
●	<i>On Screen Display</i> -----	33
●	<i>OSD Option</i> -----	33
●	<i>Time code</i> -----	34
●	<i>Under Monitor Display (color: Tally R/G mode action )</i> -----	34
●	<i>Input ID</i> -----	34
●	<i>SDI Signal state</i> -----	35
●	<i>Advanced</i> -----	35
●	<i>Information</i> -----	35
●	<i>Control</i> -----	35
●	<i>Screen Saver</i> -----	36
●	<i>Screen Control</i> -----	36
●	<i>Fan Control</i> -----	36
●	<i>Network Configuration</i> -----	37
●	<i>X768 Mode</i> -----	37
●	<i>Caption</i> -----	37
●	<i>Waveform Format (SDI ONLY)</i> -----	38
●	<i>Y-Pb-Pr Waveform</i> -----	38
●	<i>Y-Waveform + Vector Scope</i> -----	38
●	<i>Double</i> -----	39
●	<i>Y-Waveform + Vector Scope Trans</i> -----	39
●	<i>Vector Color</i> -----	39
●	<i>Line Select</i> -----	39
●	<i>Line #</i> -----	40
●	<i>Line Display</i> -----	40
●	<i>Dual Link Mode (SDI only)</i> -----	40
●	<i>Set ID &amp; Active Set ID</i> -----	40
<b>13.</b>	<b>PIP (PICTURE IN PICTURE)</b> -----	<b>40</b>
●	<i>PIP ON/OFF</i> -----	40
●	<i>Input Source</i> -----	40

---

- *Aspect Ratio* ----- 41
- *Position*----- 41
- *PIP Blend*----- 42
- *PIP Swap* ----- 42
- *Audio Select* ----- 42
- *Sub Window Function*----- 42

**14. OSD TREE ----- 44**

- 1) VIDEO----- 45
- 2) AUDIO ----- 46
- 3) MARKER----- 47
- 4) GPI ----- 48
- 5) SETUP----- 49
- 6) PIP ----- 50

**15. MECHANICAL DIMENSION----- 51**

- 1. SFP-317-H----- 51
- 2. SFP-321-H----- 51
- 3. SFP-324-H----- 52

## Precaution

*Before operating the set, please read this manual carefully.*

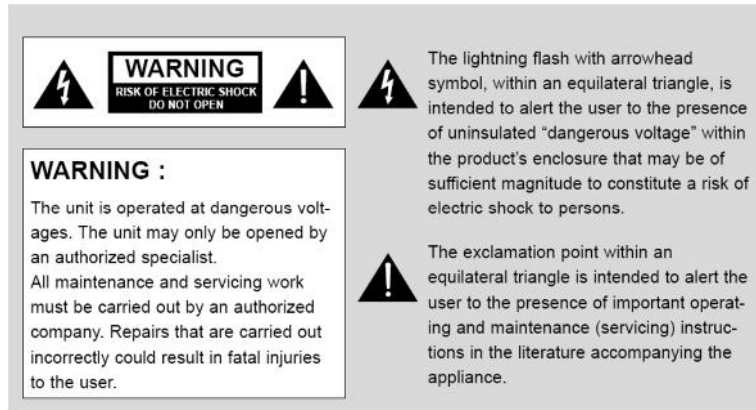

### ***WARNING :***

To reduce the risk of any electric shock, do not remove back cover as there are no user serviceable parts inside. Please refer to Plura or a qualified service personnel/agent. To prevent fire or shock hazard, do not expose the rear side of the unit to rain or moisture. Do not rub or clean the Active Matrix LCD with any harsh surface as this may scratch, mark, or damage the Active Matrix LCD permanently.

### ***CAUTION :***

Unauthorized tampering with the inside of the monitor voids the warranty.

The manufacturer shall not warrant for any damage caused by improper maintenance and/or repair by any third party.

Important safeguards for you and your new product:

Please read and observe the following safety points when installing and using your new device and save them for future reference.

*1. Read Instructions*

*2. Follow Instructions*

*All operating and use instructions should be followed.*

*3. Retain Instructions*

*The safety and operating instructions should be retained for future reference.*

*4. Observe Warnings*

*All warnings on the product and in the operating instructions should be adhered to.*

*5. Cleaning*

*Disconnect the unit from the mains before cleaning. Do not use abrasive cleaners. Use a damp cloth for cleaning.*

**6. Water and Moisture**

*Do not use this unit near water.*

**7. Transportation**

*A product should be transported with care. Excessive force and uneven surfaces may cause the damage to product.*

**8. Attachments**

*Do not use attachments not recommended by Plura as they may cause hazards.*

**9. Ventilation**

*Do not block any of the ventilation openings.  
Install in accordance with the manufacturer's instructions.*

**10. Power Sources**

*This product should be operated only from the type of power source indicated on the marking label. If you are not sure of the type of power supply, consult your power company.*

**11. Power Lead Polarization**

*This product is equipped with a three-wire grounding-type cord. This is a safety feature. Do not use an alternative power cord.*

**12. Power Cord Protection**

*Power-supply cords should be protected so that they are not likely to be walked on or pinched by items placed upon or against them, paying particular attention to cords at plugs, convenience receptacles and the point where they exit from the product.*

**13. Outdoor Cable Grounding**

*If an outdoor cable is connected to the product, be sure the cable is grounded to provide some protection against voltage surges and built-up static charges. A "face plate" also needs to be installed with an isolating capacitor to prevent any damage from static.*

**14. Lightning**

*For added protection for this product during a lightning storm, or when it is left unattended and unused for long periods of time, unplug it from the wall outlet. This will prevent possible damage to the product due to lightning and power-line surges.*

**15. Earthing the product**

*This product must be earthed properly to comply with the safety regulations in the country of use. If you are unsure of these regulations, please consult a qualified electrician.*

**16. Servicing**

*Do not attempt to service this product yourself as opening or removing covers may expose you to dangerous voltages or other hazards. Refer all servicing to qualified service personnel. If the device does not operate properly, switch it off and call your dealer.*

**17. Service**

Turn this product off, unplug from the mains supply and refer servicing to qualified service personnel under the following conditions:

- A. If the power-supply cord or plug is damaged.
- B. If the LCD has been damaged.
- C. If water or moisture penetrated the glass and/or the LCD screen.
- D. If the product does not operate normally by following the operating instructions. Adjust only those controls that are covered by the operating instructions as an improper adjustment of other controls may result in damage and will often require extensive work by a qualified technician to restore the product to its normal operation.
- E. If the product has been dropped or the frame has been damaged.
- F. If the product exhibits a distinct change in performance.

**18. Safety Check**

Upon completion of any service or repairs to this product, ask the service technician to perform safety checks to determine that the product is in proper operating condition and the front seal is intact.

**19. Mounting**

The product should be mounted on a wall only as recommended in the instructions.

**20. Power**

This device operates on an AC supply; the voltage is as indicated on the label on the Manual. This device must be earthed at all times through the chassis as well as through the power lead.



Note

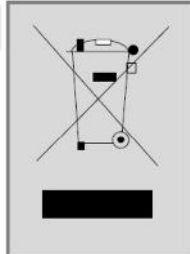

This product is designed and manufactured with high quality materials and components which can be recycled and reused. This symbol means that electrical and electronic equipment, at their end-of-life, should be disposed of separately from your household waste. Please, dispose of this equipment at your local community waste collection/recycling centre. In the European Union there are separate collection systems for used electrical and electronic product. Please, help us to conserve the environment we live in!



## 1. OVERVIEW

SFP-H & SFP-H-7 are the NEW FUTURE PROOF Hybrid Monitor Series, supporting Coax, Fiber & IP connectivity.

These series will be available in multiple sizes starting from 17" all the way to 84".

The SFP-H is integrated with powerful H/W & S/W platforms to support Coaxial 3Gb/s BNC I/O connectivity, Coaxial SFP I/O connectivity, IP SFP+ over Fiber decoding "ST-2110 & ST-2022" with Third-Party H/W decoder and the NEW PIPM-R-7 "Plura FPGA based module supports 3G SMPTE ST 2110 signals across dual 10 GigE and it features 2x 10 GbE SFP+ cages complying with SMPTE ST 2022-7, providing redundancy protection for critical distribution and monitoring applications "hitless switching". The PIPM-R-7 is standard with SFP-H-7 and can be integrated into any size SFP-H monitor.

## 2. GENERAL FEATURES

- The New FUTURE PROOF SFP-H, Hybrid Monitor Series, supporting Coax, Fiber & IP connectivity
- Decode ST-2110, ST-2022 and ASPEN IP streams with "PIPM" Plura Software Stack IP Platform module
- Supports Coaxial 3Gb/s BNC I/O connectivity
- Supports Coaxial SFP I/O connectivity
- Supports IP SFP+ over fiber decoding "ST-2110 & ST-2022" with any Third-Party H/W decoder
- 2 x SFP+ cages supporting 10G/3G/1.5G SDI
- 1 x 3G/1.5G Input port
- 2 x 3G/1.5G output ports
- LKFS Audio Loudness logging & measurement
- \*"PIPM-R-7" Plura Software Stack IP Platform - OPTIONAL
- Built-IN 4 x 4 Crosspoint Solution
- 1 x HDMI, 1 x DVI & other legacy I/O
- 178 degree Viewing Angle Display
- Gamma Selectable ( 0.8 - 3.0)
- Color Temperature - User, VAR, Adjustable (11000K TO 3200K)
- (ICAC) - Plura Intelligent Connection for Alignment & Calibration
- Display Advanced Waveform & Vector Scope simultaneously with line select
- Various and User defined Markers Display & Safe Area
- Programmable 3 User Front Pushbutton Controls & GPI
- Closed Caption (608/708) - North American Market
- Cutting edge De-interlacing and scaling Technology
- Fast Response Time for high motion video
- Internal Monitor Display (IMD)
- Ethernet & RS232 Remote Control
- Underscan / Overscan / Normal / Zoom
- Pixel to Pixel Mode, Tally, DC operation only "SFP-317-H & SFP-321-H"
- False Color and Peaking Filter / Focus Assist
- Video Range test with adjustable Y & C values
- Display LTC & DIVTC time code with line select
- Embedded Audio input, Digital Audio Decoding
- Internal Pattern Generator and Wall Control System
- Auto Calibration: Spyder Elite / CA-210 & CA-310(Minolta) / K-10(Klein) / Jetti

### 3. Functions and I/O descriptions

1) Front

- SFP-317-H

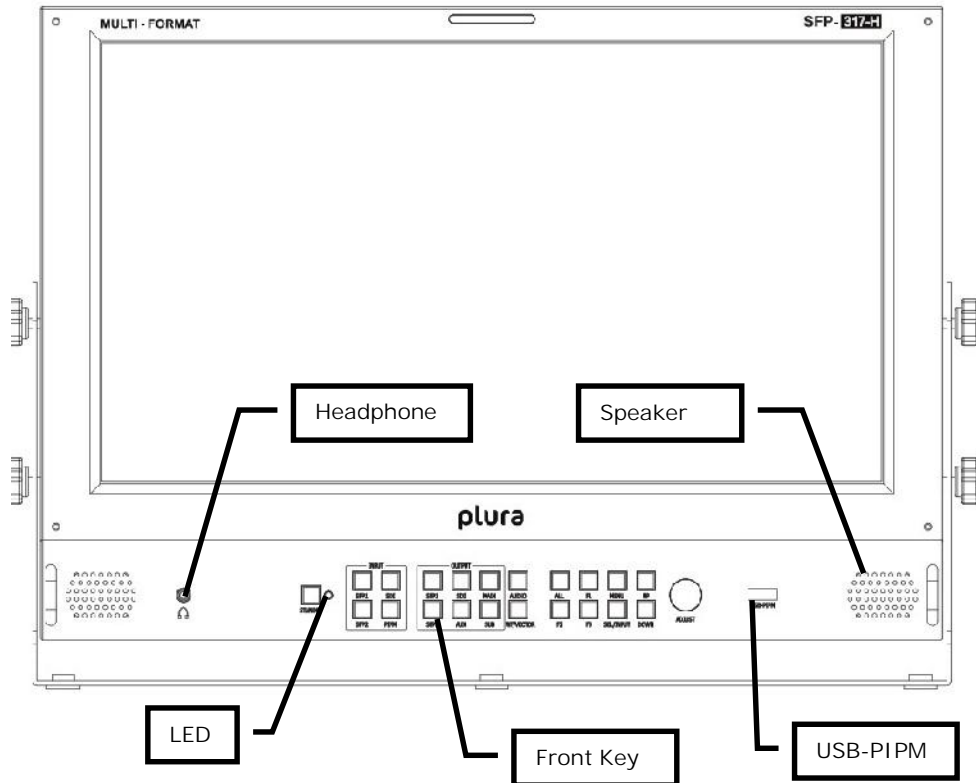

- Front Keypad

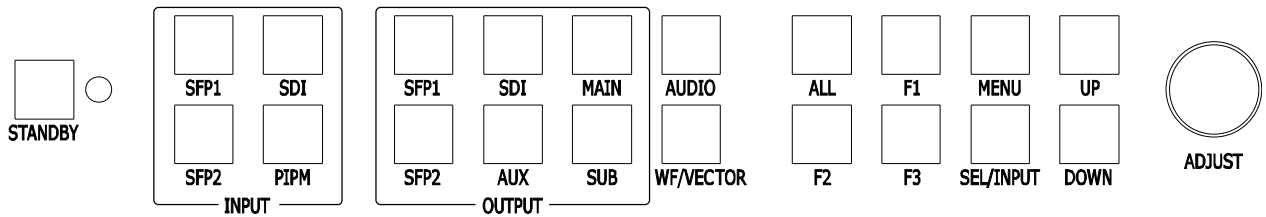

- Front Keypad Operations

Key Name	Operation
STANDBY	▶Power ON/OFF Button. This button is operated after being pressed about 3 seconds.
INPUT SFP1/SFP2/SDI/PIPM	▶SFP Modules Input CH selected. ▶Channels in the input signal, the key led light.
OUTPUT SFP1/SFP2/SDI/AUX/ MAIN/SUB	▶SFP Modules Output CH selected.
ALL	▶SFP Modules ALL Output CH selected.
FUNCTION F1/F2/F3	▶Executes functions of user selected. UNDEF, Aspect, Mono/Blue only, Audio Channel, Safety area marker, Time code, Analog Caption, Audio mute, Still image, Zoom, Flip, Gamma select, PIP func & Input, Sub win full, Sub win part
SEL/INPUT	▶Activates OSD menu of input source selecting. ▶Changes input source by selecting. ▶Executes functions (by OSD help commands) in main OSD menu. ▶Activates child menu.
MENU	▶ Activates main OSD menu. ▶ Navigates higher menu in main OSD menu. ▶ Exits OSD menu.
Adjust	▶Adjust Picture Menu(Brightness -> Contrast -> Color -> Sharpness->Phase & Tint) ▶Turn Right (with „UP’ button is same) ▶Turn Left (with „DOWN’ button is same)

- SFP Modules Information

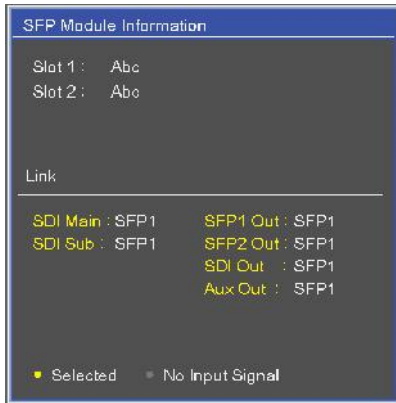

- ) SFP1/SFP2: SFP Module information will be displayed when available.
- ) The selected output channel will be in Yellow.
- ) SFP1/SFP2/SDI/PIPM: Available input channels.
- ) SFP1/SFP2/SDI/Aux/SDI Main/SDI Sub: can be selected as output port.

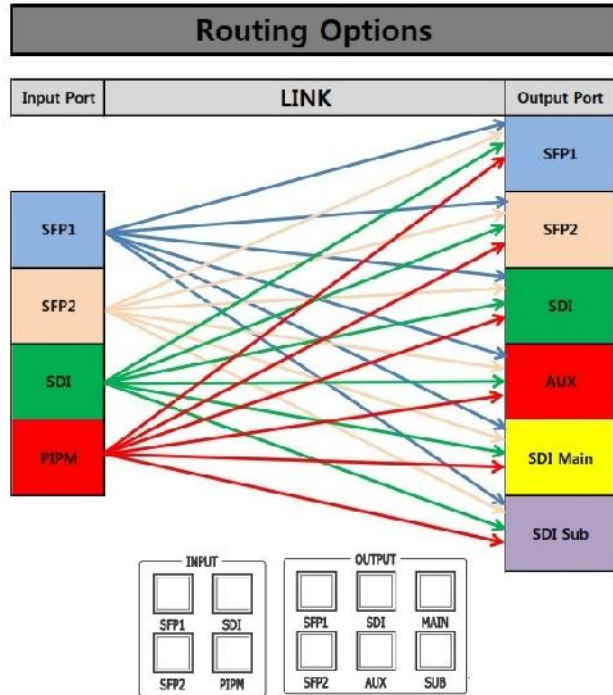

- Front panel LED Operations

- ) Green LED ON when Function Key and Power On
- ) RED LED ON in standby mode

- Speaker Out

Interface	Description
Speaker R/L out	8 ohm±15%, Max 3W + 3W

2) **Rear**

● I/O Details

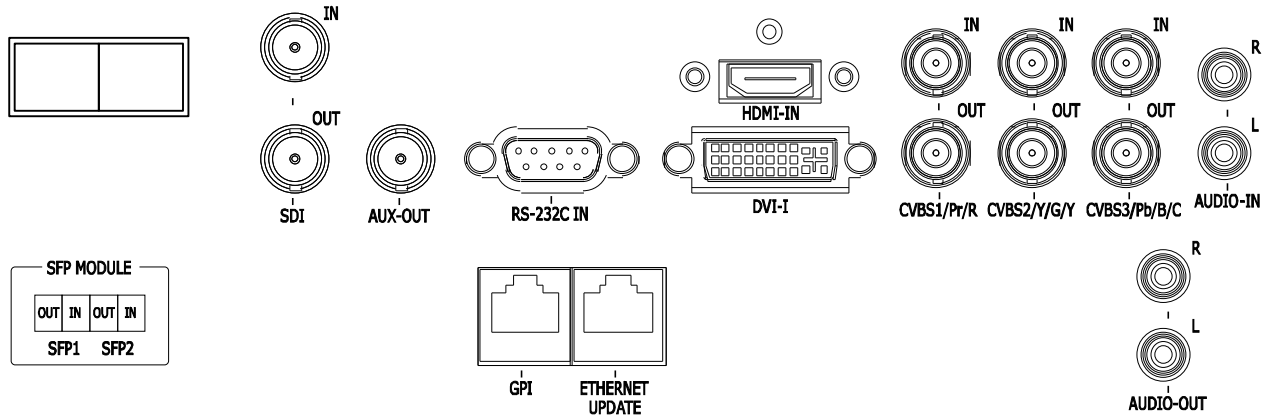

● Power IN – AC & DC

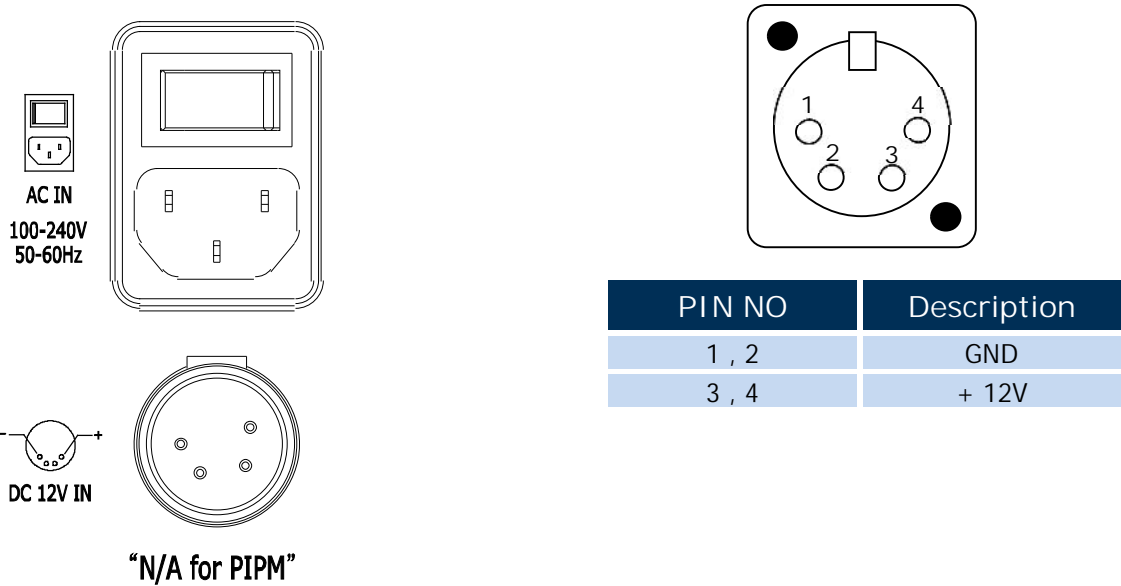

\*DC is not applicable when using PIPM- R- 7

- PIPM-R-7 OPTION

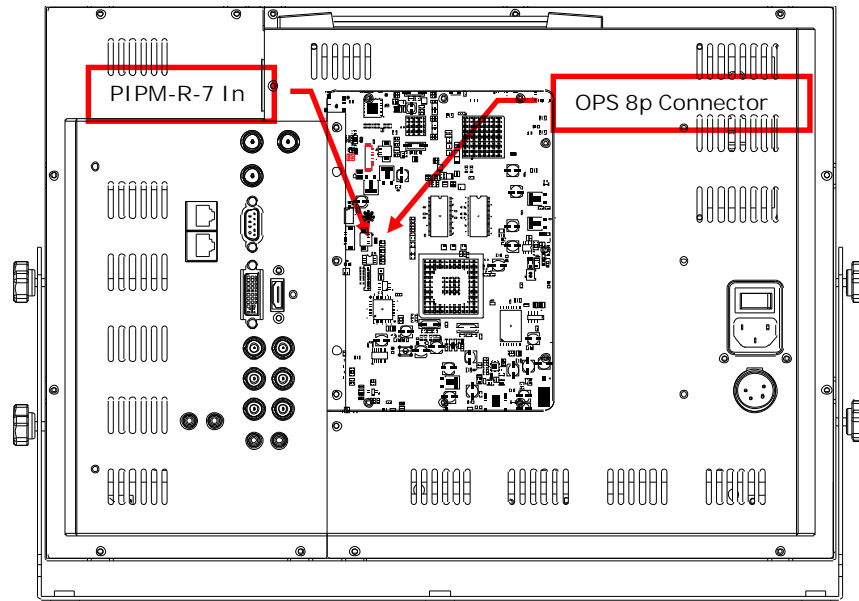

- PIPM-R-7 Connectivity



- PIPM-R-7 configuration page

Please enter the static IP address listed on the back of the monitor.  
You will see the below webpage.

- 1- Select Video Level
- 2- Set PTP

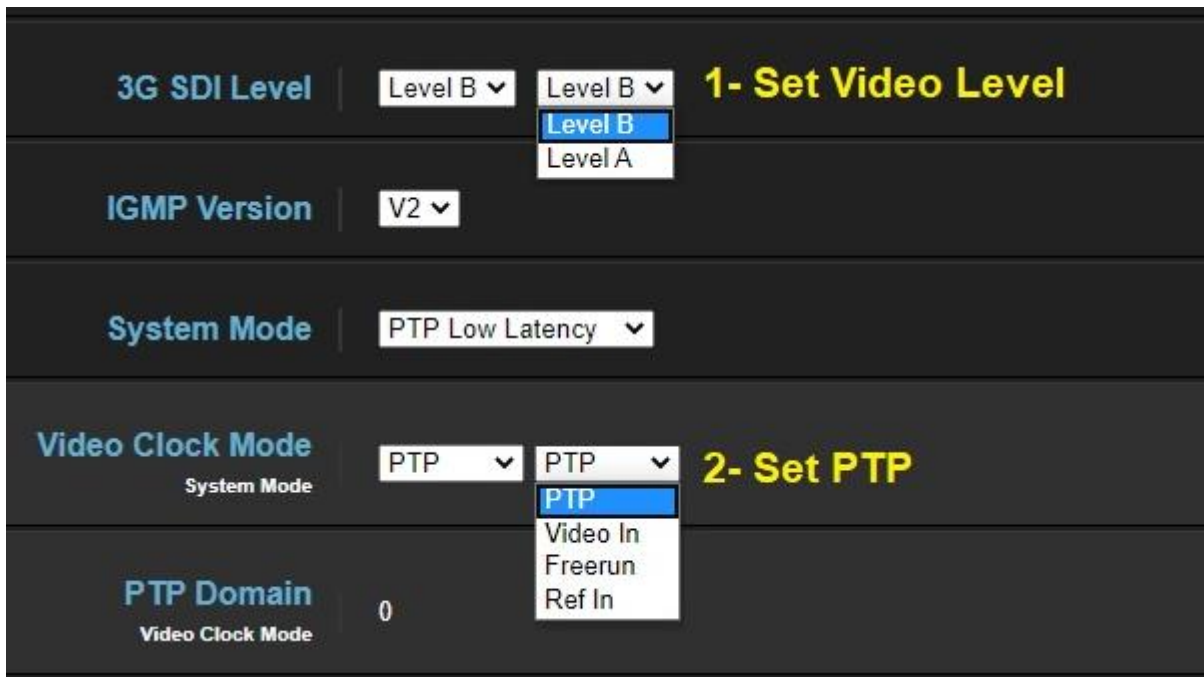
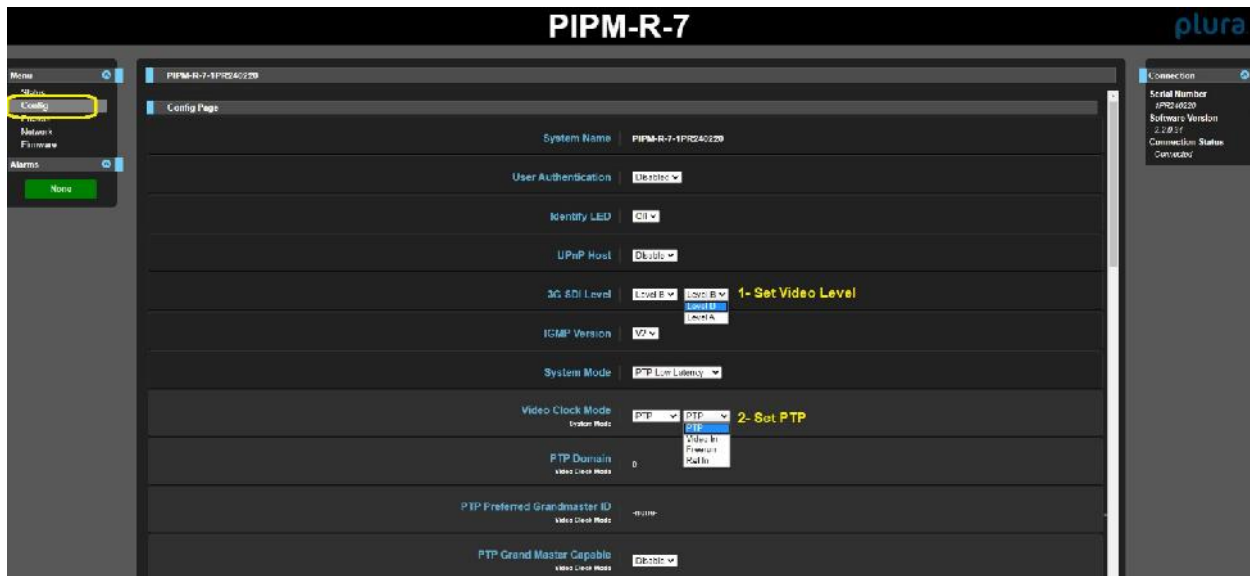

3- Select input setting

Select SDP, Manual or NMOS/Ember.

SDP - The SDP method greatly simplifies the configuration process for the Input Stream Selection fields.

Selecting SDP causes the following four fields to display:

- SDP URL Video - Enter the SDP URL Video string.
- SDP URL Audio - Enter the SDP URL Audio string.
- SDP URL Video 2 - Enter the SDP URL Video string.

- SDP URL Audio 2 - Enter the SDP URL Audio string.

<b>Input Stream Selection</b>	SDP	<b>3- Set SDP, Manual or NMOS/Ember.</b>
<b>Video Input Format</b> Input Stream Selection	SDP Manual NMOS/Ember NTSC 720i	<b>SDP</b> - The SDP method simplifies the configuration process for the Input Stream Selection fields.
<b>Video Payload Type</b> Input Stream Selection	96	The strings entered into the SDP URL Video and SDP URL Audio fields point to SDP files that are created by the source that is transmitting the video signal.
<b>Audio Channels</b> Input Stream Selection	0	<b>Manual</b> - When Manual is selected, you must enter configuration parameters manually into the following Input Stream Selection fields:
<b>Audio Packet Interval</b> Input Stream Selection	125 us	<ul style="list-style-type: none"> <li>• Video Input Format</li> <li>• Audio Channels</li> <li>• Audio Packet Interval</li> </ul>
<b>Video Destination Address</b> Input Stream Selection	239.218.1.2	
<b>Video Source Address</b> Input Stream Selection	- Ignore -	<b>NMOS/Ember</b> - When NMOS/Ember is selected, input stream selection occurs through network discovery and communication with facility automation.

The strings entered into the SDP URL Video and SDP URL Audio fields point to SDP files that are created by the source that is transmitting the video signal.

The SDP files contain all required configuration parameters for the following Input Stream Selection fields:

- |  |   |
|--|---|
| <ul style="list-style-type: none"> <li>• Video Input Format</li> <li>• Video Destination Address</li> <li>• Video Source Address</li> <li>• Video 2 Destination Address</li> <li>• Video 2 Source Address</li> </ul> | <ul style="list-style-type: none"> <li>• Audio Channels</li> <li>• Audio Packet Interval</li> <li>• Audio Destination Address</li> <li>• Audio Source Address</li> <li>• Audio 2 Destination Address</li> <li>• Audio 2 Source Address</li> </ul> |
|--|---|



● RJ-45 Connections

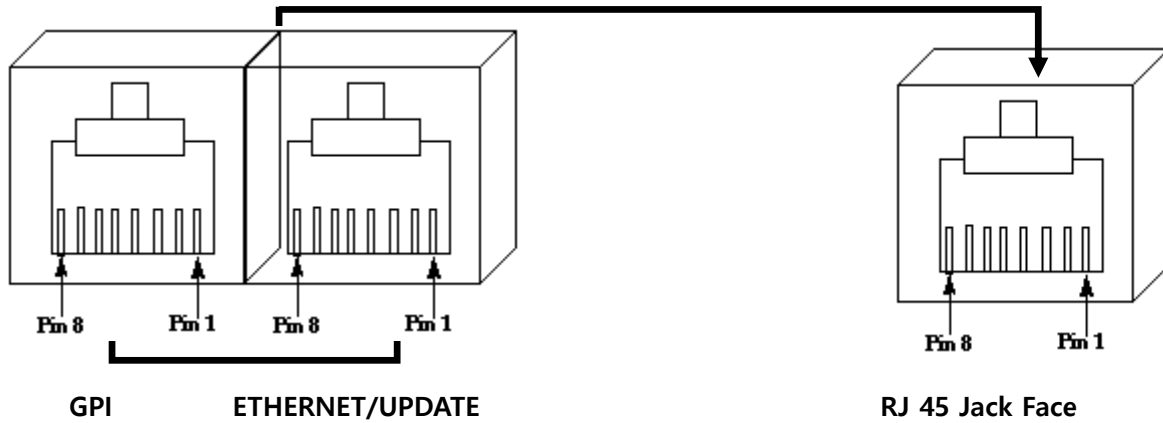

- Firmware Upgrade/ System Controller (Ethernet) & GPI

Remote PIN Assignment			
8 PIN	COMMON(GND)	4 PIN	GPI 4 PORT
7 PIN	GPI 7 PORT (STAND BY/POWER ON/OFF)	3 PIN	GPI 3 PORT
6 PIN	GPI 6 PORT	2 PIN	GPI 2 PORT
5 PIN	GPI 5 PORT	1 PIN	GPI 1 PORT

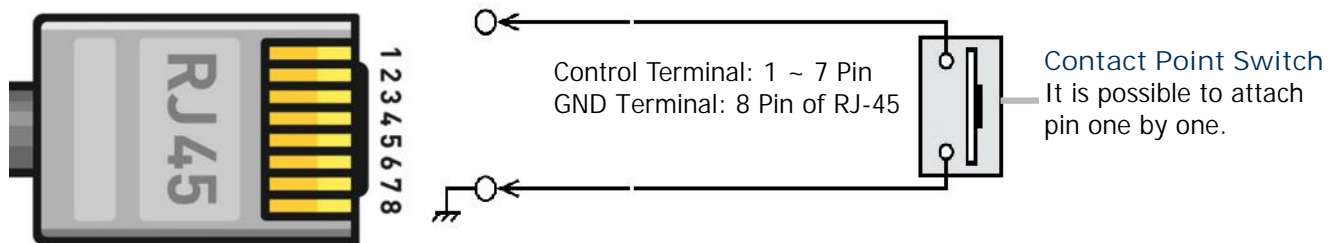

● I/O Description

Interface	Description	
SFP Module 2 Slot	Input CH 1	Output CH 1
	Input CH 2	Output CH 2
SDI	Input	Output
AUX		Output
RS-232 IN	Update/Multi Control/Auto color calibration	
HDMI	High Definition Multimedia Input	
DVI-I	DVI-I Type Digital / Analog PC-RGB Video Input High Definition Multimedia Input Compatible	
CVBS1/Pr/R In	GBR (SOG sync) Input	

CVBS2/Y/G/Y In	Y, Pb, Pr Component Video Input
CVBS3/Pb/B/C In	CVBS / Composite/S-Video Input
CVBS1/Pr/R Out	Component/GBR/Composite1,2,3/ S-Video Loop Out
CVBS2/Y/G/Y Out	
CVBS3/Pb/B/C Out	
AUDIO R In	DVI-I/Component/GBR/Composite1,2,3/S-Video
AUDIO L In	Sound Input
AUDIO R Out	AUDIO MONITOR OUT
AUDIO L Out	
AC IN	AC90V ~ 240V, 50Hz/60Hz
DC IN	PBM-217: DC 11V ~ 17V ,PBM-224: DC 24V
ETHERNET UPDATE	ETHERNET/Firmware Upgrade
GPI	GPI 1 ~ 7 Control Port

## 4. MENU OVERVIEW

In this menu system, there are several ways to customize the menu settings.

Most menus consist of three levels to select the correct option/s, but some require greater depth for variety of settings. If you press the MENU button, only the first and second level of the menu system will appear on the monitor screen. The third level can be displayed by pressing SEL/INPUT. If a menu has more than three levels, the pop-up dialogue box will be displayed as the fourth or fifth level.

- To display / hide the Menu  
Press the MENU button to display the menu. To exit the menu, press the MENU button second time.
- To go to the next level  
Press SEL/INPUT button.
- To go back to the previous level  
Press MENU button



- Typical Menu Operation

1. Press MENU button: The main menu will be displayed.
2. Use Adjust / Take button Turn Right/ Left to select the desired menu option (icon).

3. While the desired menu option is selected, press SEL/INPUT to move to the second level.
4. Use Adjust / Take button Turn Right/ Left to select the second menu option.
5. Press SEL/INPUT to move to the third level: Some menu options require additional steps.
6. Press MENU to return to the previous menu to return to monitor viewing.

## 5. BASIC OPERATION

### ● Turning ON & OFF the Monitor

1. First and foremost connect the power cord correctly. The monitor will be in standby or power ON mode. If the monitor is In standby mode, in order to turn monitor ON, press and hold the Standby button for at least 3 seconds.
2. Select the input source by using SEL/INPUT button on Keypad in front of monitor.
3. To turn the monitor OFF, press and hold the Standby button for at least 3 seconds.

### ● Volume Adjustment

1. Press the Adjust / Take button Turn Right/ Left button on Keypad.
2. If you want to turn the sound off, press the FUNCTION (Audio mute) button.
3. You can cancel this function by pressing the FUNCTION (Audio mute) or volume control button.

### ● On Screen Menu Language Selection



- SETUP -> On Screen Display -> OSD Option -> Language
- The menu can be shown on the screen in the selected languages.
- Supported Languages: English, Spanish, Portuguese, German, French and Italian

## 6. On Screen Menus Selection and Adjustment

- How to adjust the OSD screen

1. Press the MENU button and then UP/DOWN button to select each menu.
2. Press the SEL/INPUT button and then use UP/DOWN (SEL/INPUT)/MENU button to display the available menu.

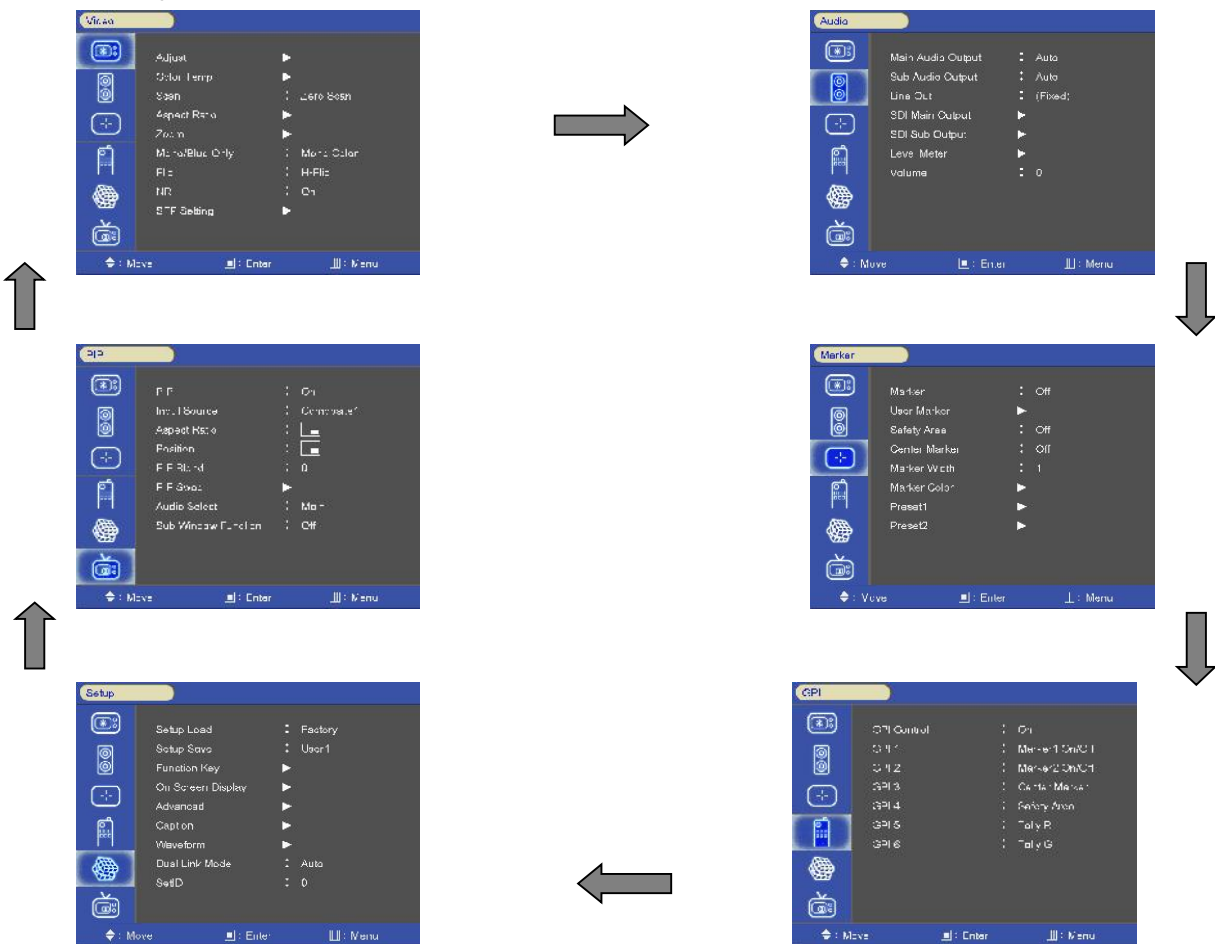

\*Some monitors OSD (On Screen Display) may differ slightly from what is shown in this manual.

## 7. SELECT VIDEO INPUT

- How to Select Video Source by OSD

1. Press the SET/INPUT button and then UP/DOWN button to select the desired video source.
2. Press the SET/INPUT button to go to desired video source.
3. If Input Name is enabled, The SET/INPUT button will display input name as entered in edit mode.

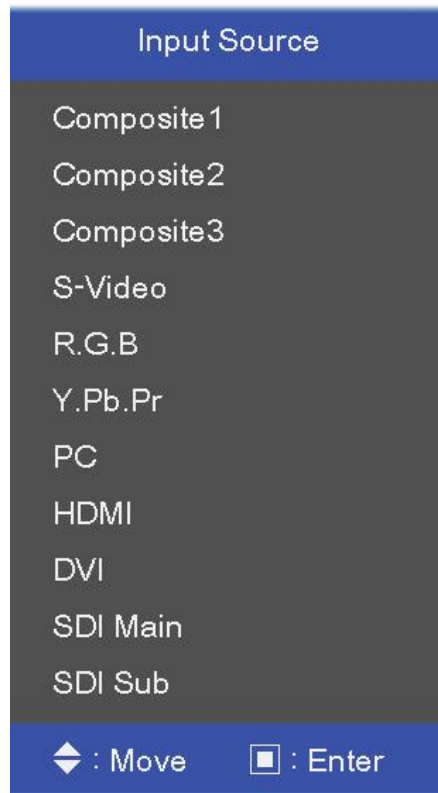

## 8. MENU OPTIONS FOR DIFFERENT I/P SOURCES

- Menu of different Input source



< Video (NTSC) menu >



< PC menu >



< SDI, HDMI menu >

- Adjust



- Adjust the values of Brightness, Contrast, Color, Tint and Sharpness directly from -50 to 50

Contrast, Brightness, Sharpness, Color (All Sources), Tint N/A (PC, DVI, HDMI, Component), Phase (Component).

- Color Temperature Control



- For Setting the Color temperature or adjusting RGB gain value.

- User (User setting RGB gain value), VAR(3200K ~ 11000K), Often used value (11000K, 9300K, 6500K, 5400K, 3200K)

- SCAN



1. Over Scan – 95% input size and fit the selected display resolution.
2. Zero Scan – 100% input size and fit the selected display resolution.
3. Under Scan – 105% Input size and fit the selected display resolution.
3. Pixel to Pixel – Displays the exact input resolution regardless of the panel resolution.

● Aspect Ratio

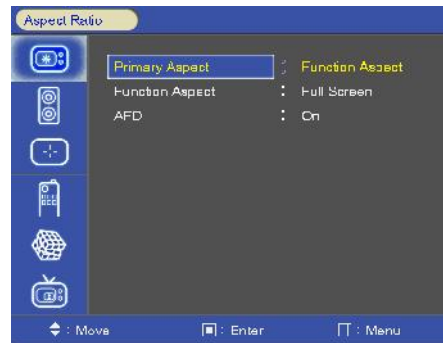

- For setting the aspect ratio.
- Full Screen: The images are displayed to the full panel resolution.
- Full Screen, 16:9, 4:3, 14:9, 13:9, 1.85:1, 2.35:1: The images are displayed to the selected aspect ratio.
- AFD function Added
- PC mode: Full Screen & 4:3 only

● Zoom



- Zoom picture by (2X, 3X, 4X, 5X) ratio.
- If user selects the Zoom 3X option, the monitor will divide the image into 3x3=9 portions and the monitor will display the yellow box in picture as shown below.
- Press Select or Enter button, user can see the enlarged picture of the selected portion.
- Pressing Menu key will exit the zoom mode.

- Example (3X3)



Zoom X position: Coordinate of video image's H position.  
 Zoom Y position: Coordinate of video image's V position.

- Mono/Blue Only



- Mono color: For selecting monochrome images.
- Blue Only: IN blue ONLY

- PC Menu (pc mode only)

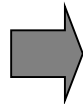
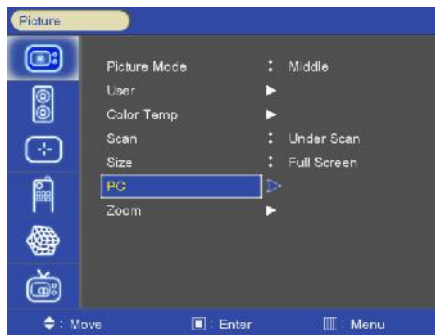

- PC input mode ONLY
- Select Auto-adjust to adjust Phase, HV position, Frequency
- Auto-Adjust automatically set the optimum values of Phase, HV position and Frequency.

- Flip

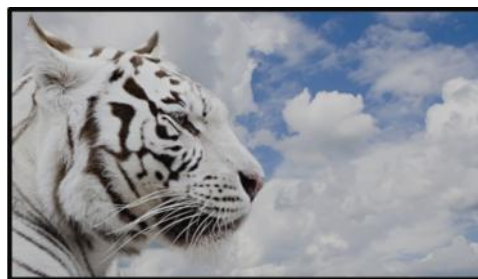
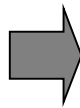

< H-Flip Off >

< H-Flip On >

-H-Flip Display ON/OFF



- NR (Noise Reduction)
- Noise Reduction on/off. (NR is for Video signal (HD-SDI, Composite, S-Video and Y.Pb.Pr) & DTV timing.

- SFP Setting

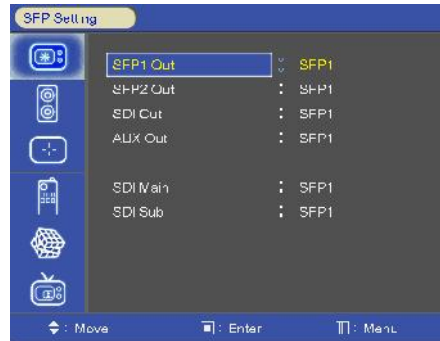

- SFP 1 / SFP 2 / SDI / AUX / SDI Main / SDI Sub available Output ports.
- SFP 1 / SFP 2 / SDI / PIPM available Input ports.

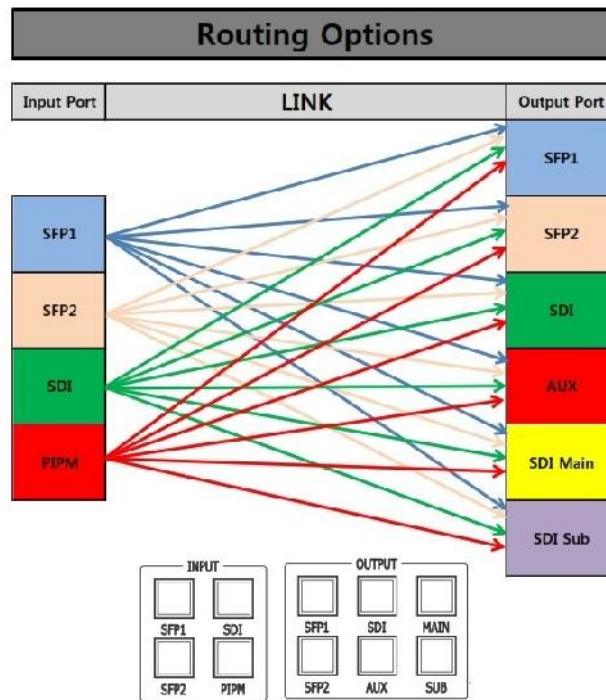

## 9. AUDIO MENU OPTIONS

- MAIN / SUB Audio out



-Main: Select Internal Speaker out. (Auto/SDI1/SDI2/HDMI/Line in)

-Sub: Select sub display sound. (Auto/SDI1/SDI2/HDMI/Line in)

- SDI Main/ SDI Sub Audio Output Channel
- Audio output channel source select. (Channel1~4, Channel1/2, Channel3/4, off)
- SDI Main/ SDI Sub Audio Group

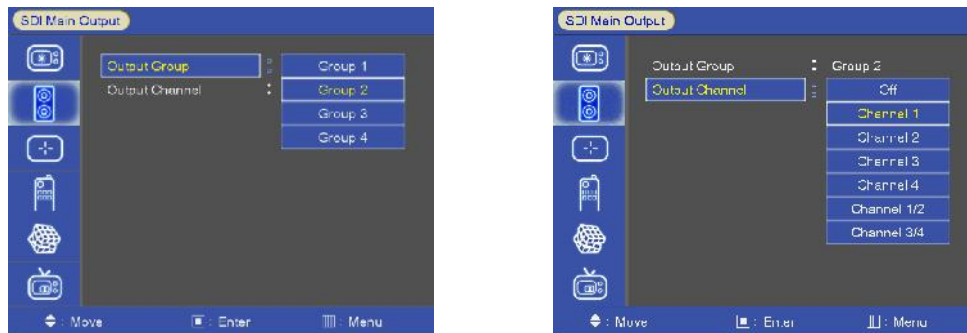

- Select primary or secondary audio group. (Group 1~4)

- Level Meter

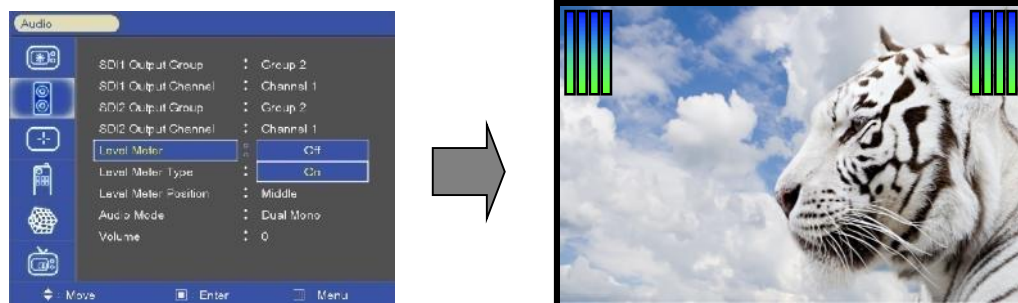

- Display the audio level meter on screen with SDI input.
- Audio level meter will NOT be display when OSD is ON.

- Level Meter Type

- Pair: Displays Right and Left Channels in pairs
- Group: Displays Right and Left Channels in groups

- Level Meter Position

- Level Meter Position selection. (TOP/Middle/Bottom)

- Level Meter Scale

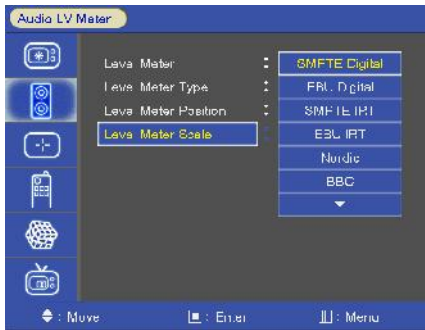

- Level Meter Scale mode selection  
 (SMPTE Digital/EBU Digital/SMPTE IRT/EBU IRT/Nordic/  
 BBC/EBU/DIN/Expander DIN/SMPTE VU/EBU VU/France  
 VU)

**AUDIO SCALES**

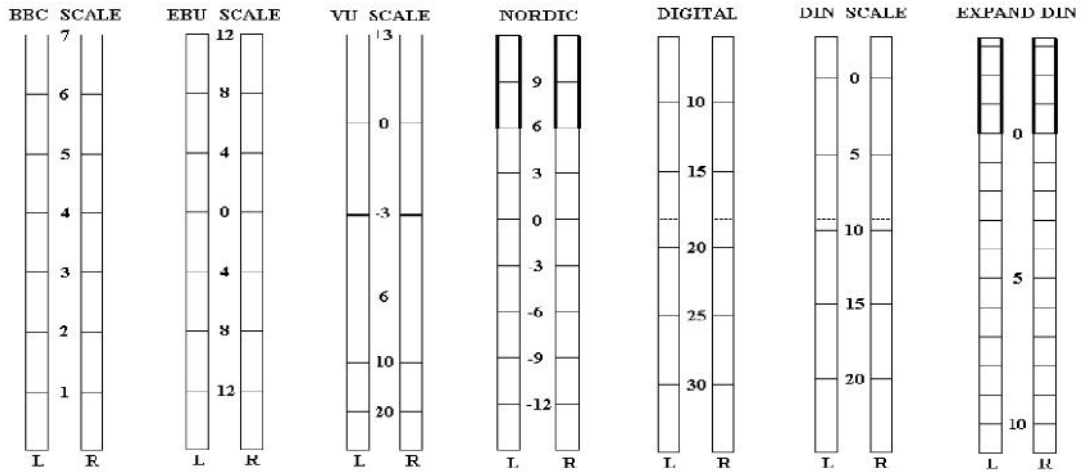

- Audio Loudness (LKFS)

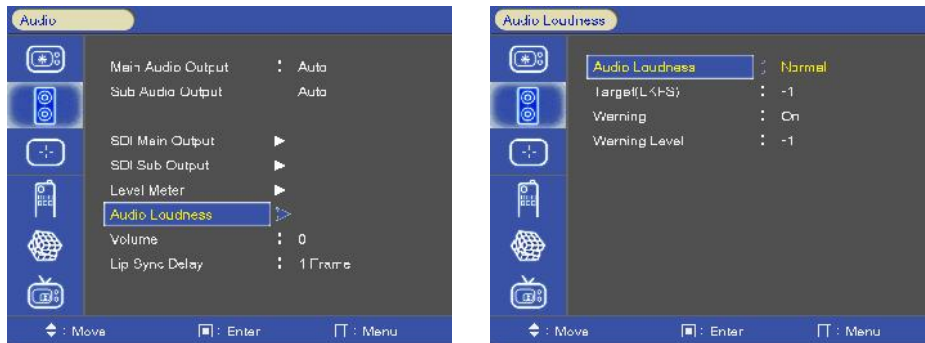

-Audio Loudness setting (Off, Normal, Transparent) and Set Target levels (LKFS)

- Volume

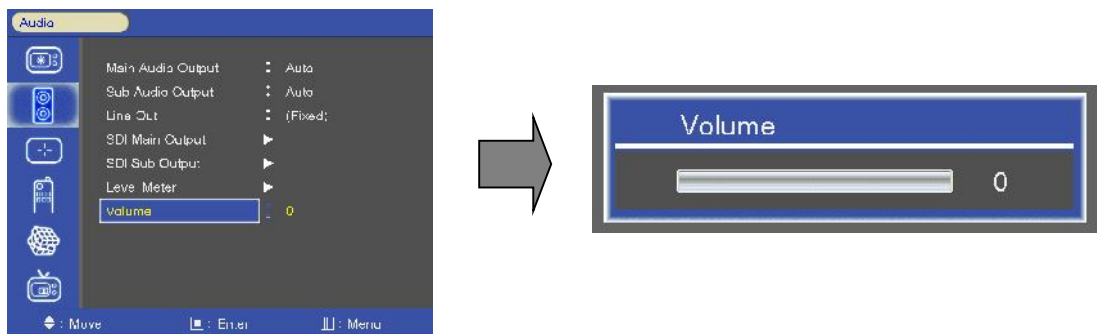

- Adjust the speaker or headphone Volume level. (0~32)

- Lip Sync Delay

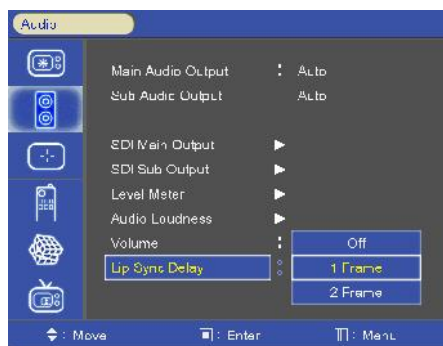

- Lip sync delay: Off, 1 Frame, 2 Frame

## 10. Marker MENU OPTIONS

- Marker & User Marker



< Marker >



< User Marker >

1. Marker : 16:9, 4:3, 14:9, 13:9, 1.85:1, 2.35:1, 1.85:1&4:3, User1, User2, User3 fitted panel size marker on screen.

2. User Marker: The user wants Marker size setting. (Below panel size)  
Example (1440x900 panel)



16:9 (16:9 Marker)



16:9 (4:3 Marker)

- Safety Area



-Safety Area: Draw dotted line Marker on screen.

-16:9 95/93/90/88/80%

-4:3 95/93/90/88/80%

-EBU Action 16:9/14:9/4:3

-EBU Graphic 16:9/14:9/4:3

- Center Maker



- "+" Marker on center of screen

- Marker Width

-Marker line thickness setting. (0~10)

- Marker Color



- Marker Line Color: Select Marker line color (White, Yellow, Blue, RED, Black)

- Safety Line Color: Select Safety line color (White, Yellow, Blue, RED, Black)

- Marker Back Color: Select Marker Back Color. (None, Gray, White, Blue, Black)

- Safety Back Color: Select Safety Back Color. (None, Gray, White, Blue, Black)

- Marker BK Blend Color: Select Marker blending level. (0 ~ 5)

- Safety BK Blend Color: Select Safety blending level. (0 ~ 5)

- Preset1 & Preset2

- For setting the marker to use by GPI controller.

- GPI preset markers are only worked by GPI controller

## 11. GPI MENU OPTIONS

- GPI Control & GPI #

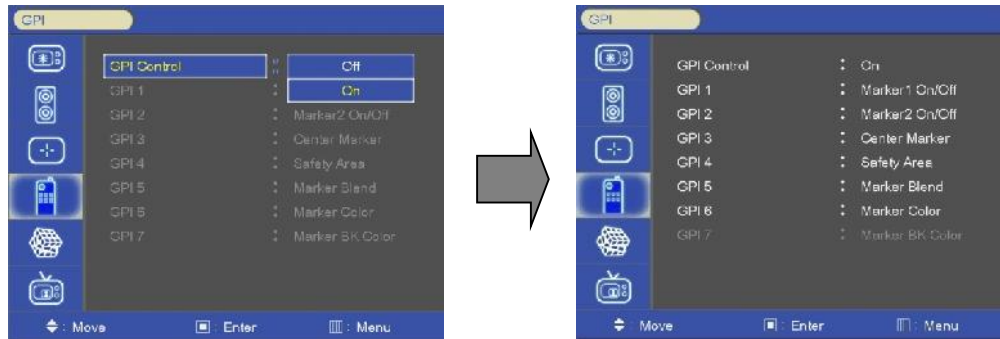

- For allocating functions to particular GPI pins.
- When remote control operations are to be performed using the GPI Controller.
- GPI Control: GPI function Enable/Disable
- GPI 1 ~ 7

GPI Function	Description
UNDEF	Not set (no function allocated)
Marker1 On/Off, Marker2 On/Off	Displays the markers which have been set by the GPI PRESET1, 2 items on the screen.
Center Marker	Displays the center marker.
Safety Area	Displays the Safety Area.
Tally R, Tally G	For lighting up the Red or Green tally LED.
Scan	Over Scan/Zero Scan/Under Scan/ Pixel to Pixel
Input Composite1, Input R.G.B., Input SDI Main, Input SDI Sub, Input Y.Pb.Pr , Input PC , Input DVI, Input HDMI	Switches the input source.
Menu Key, Enter Key, Up Key, Down Key Left Key, Right Key	Use the key function by GPI.
Function 1, Function 2, Function 3	Activates FUNCTION 1, 2, 3 buttons
Aspect	Sets the aspect ratio of the images
Waveform	Activates WAVRFORM & Vector Scope (SDI Only)
GPI 7 : Power Key(Fixed)	

## 12. SETUP MENU OPTIONS

- Setup Load & Setup Save

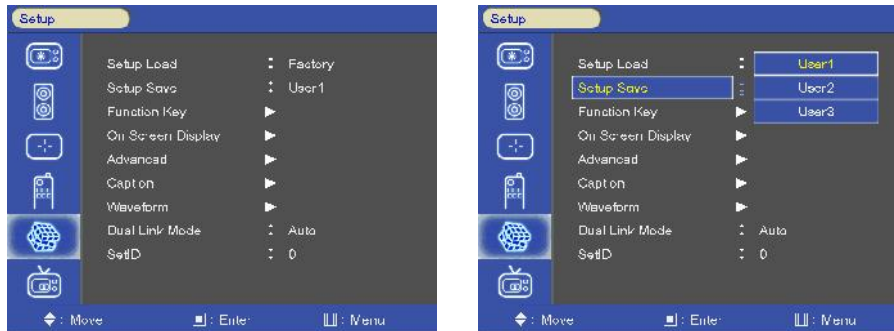

- Setup Load: Load user saved values or default value
- Setup Save: Save user setting values at user 1, 2, 3.

- Function 1 & Function 2 & Function 3

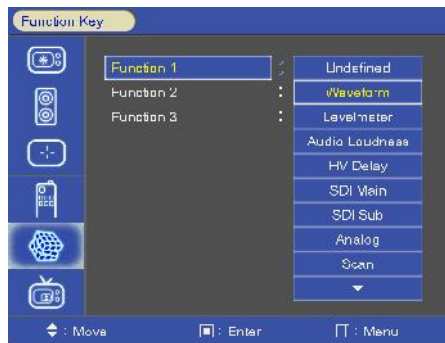

- Function 1, 2, 3: Select the function to be allocated to the FUNCTION 1, 2, 3 buttons

Function1~6 button	Description
UNDEF	Not set (no function allocated)
Waveform	Display the Waveform
Level meter	Audio LV Meter On / Off
Audio Loudness	Audio Loudness(LKFS) On / Off
H/V delay	H delay, V delay, HV delay, Off
SDI Main/SDI Sub/Analog	Select SDI Main/SDI Sub/Analog source
Scan	Over Scan/Zero Scan/Under Scan/Pixel to Pixel
Aspect	Turn ON / OFF Aspect Ratio
Mono/Blue Only	Execute Mono color or Blue Only
Audio Group	Select the embedded audio Group in SDI input.
Audio Channel	Select the embedded audio channel in SDI input.
Marker size	Select Marker size



Safety Area Marker	Select Safety Area
Time Code	Time Code Display
Caption	Closed Caption On/Off
Audio Mute	Toggles Audio speaker/headphone Mute .
Still Image	Still Image On/Off
Flip	H-Flip Display ON/OFF
Gamma Select	Gamma Level Select (0.8 ~ 3.0)
Vector Color	Select 100% or 75%
I/P Mode	Line Doubler / Inter-Field / Field Merge
Marker Preset 1/2	Displays the markers which have been set by the PRESET1, 2 items on the screen.
WFM Line Select	WFM Line Select On/Off
PIP Func & Input	PIP func & input Select
Sub Win Full	Display the same full images on POP1 screen
Sub Win Part	Scale first image to 4:3 aspect ratio and then display on POP2 screen

- On Screen Display

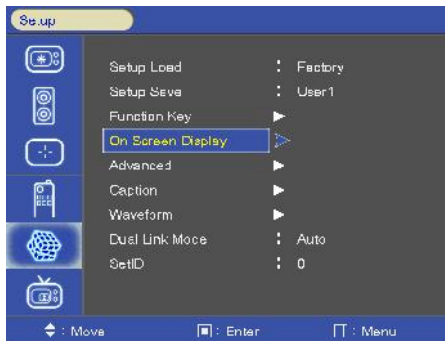

- OSD Option

- Language: Select a language for the menus to appear in. (English, Spanish, Portuguese, German, French, Italian)
- OSD Position: L-T, R-T, C, L-B, R-B
- OSD Transparency: Disable blending OSD background with video image.
- OSD Time out: OSD gone time setting. (3~200)

- Time code

- Time code Enable: Time code Display (off/VITC/ATC LTC/ATC VITC1/ATC VITC2)
- Time code size: Time code size selection. (Small, Middle, Large)
- Time code Position: Time code display position selection (L-T, C-T, R-T, L-B, C-B, R-B)
- Time code Transparency: Disable blending Timecode background with video image. (0%, 25%, 50%, 75%, 100%)
- VITC Line : Auto, Line 1~31

- Under Monitor Display (color: Tally R/G mode action )



UMD



Tally Red



Tally Green

- UMD: UMD display on/off
- UMD Character: UMD Character Select
- UMD Position: UMD display position selection (L-T, C-T, R-T, L-B, C-B, R-B)
- UMD FG Color: UMD Character color Select (RGB\_255\_192\_128\_Transparent)
- UMD BG Color: UMD BG color Select (RGB\_255\_192\_128\_Transparent)



- Input ID



OSD Message



Info Message



Timecode

- Input ID: source Message display.
- ID Style: select "Input Format"/"Custom Label"

→ Input Label: Display user custom name instead of standard input source ID on source OSD and message OSD

- SDI Signal state

SDI Signal state display on/off (H/V sync, image, Audio, Audio Phase, EDH packet, EDH FF CRC, EDH APCRC, SAC, EAV, VPI)

- Advanced



- Information, Control, Screen Saver, Screen Control, Fan Control, x768 Mode

- Information



- Version, Release day, Release time, operating time, FPGA Version, Calibration ID

- Control



- FRONT LED: Front LED on/off  
 - Local Enable: Power, up and down keys are active ONLY, if Local enable is off.  
 - Remote Enable: Select local or remote control. If remote control is ON, both local (front keypad) and remote are active. However, when local is ON, ONLY local control is enabled.  
 - Auto Key Lock: The front Keypad automatically locks for any non-activities after 10 minutes. To unlock, press and hold any Key button for about 2 seconds.

- Screen Saver



- Blue Screen: Enables screen saver functions if necessary.
- BG Gray: Select gray level for outside video boundary
- Power save Mode: DPMS (Display Power Management Signaling) Power Save Mode

- Screen Control

- Reset Calibration
  - Color Calibration Reset
- Backlight Adjust
  - Inverter dimming Level select (0~100)
- Gamma Select
  - Gamma Level Select (0.8 ~ 3.0)
- I/P Mode
  - Line Doubler/inter-Field/Field Merge function on/off
- Dithering
  - Dithering function on/off
- Internal Pattern:
  - 100% Color Bars, 75% Color Bars, Luma, RGB, White, Black, RED, Blue, Green

- Fan Control

- Fan Control: Internal Fan with temperature sensor Control, Auto / force on / force off
- Fan Active Temperature: Adjusts fan temperature in Celsius degree. ONLY available when the Fan Control set to Auto.
- Hysteresis: Adjusts fan hysteresis temperature in Celsius degree. (1~10°C)
- Shutdown: For a monitor protection, if the inside temperature reaches 75 °C, the monitor will shut its self down.
- MCU Fan Control: Control main MCU Fan On/Off

- Network Configuration

-Plura System Controller (PSC-400/500) Network setting.

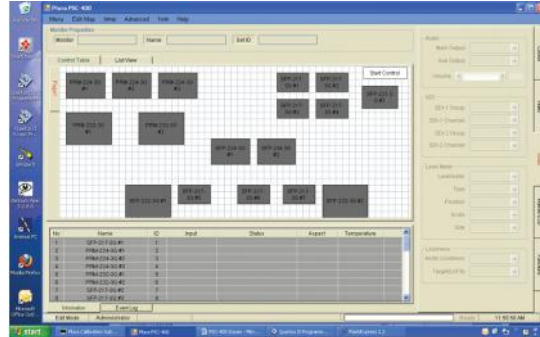
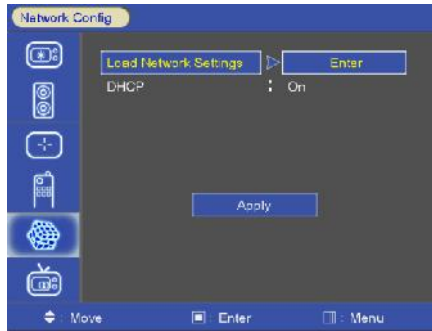

→Load Network Settings: select "Enter". (IP Address/Gateway/Subnet Load)

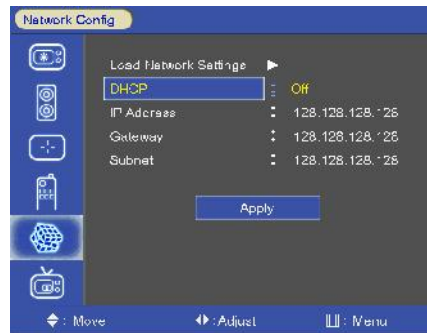
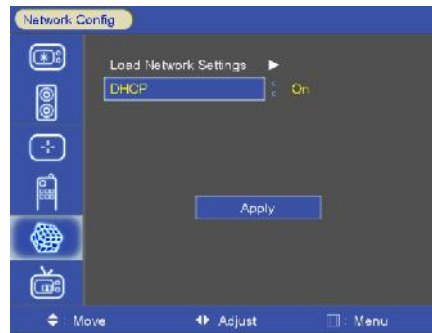

→DHCP: DHCP on/off (Manual IP settings – DHCP on) and Select "Apply" .

- X768 Mode

-Selects X768 native PC video timings. (Auto/1024x/1280x/1360x/1366x)

- Caption

→Closed Caption: 608 Line21, 608 ANC, 608 Trans-coded mode Select

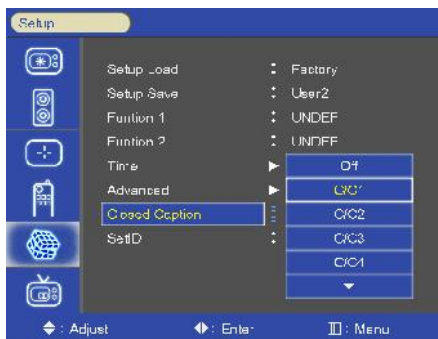

- 608 Caption mode Select. (C/C1, C/C2, C/C3, C/C4, TEXT1, TEXT2, TEXT3, TEXT4, OFF)

- Waveform Format (SDI ONLY)

Press the WAVEFORM button to display the WAVEFORM Mode

- Y-Pb-Pr Waveform



- Y\_Pb\_Pr WAVEFORM, Audio Level Meter, Video Info status & Time code Display.

- Y-Waveform + Vector Scope



- WAVEFORM & Vector Scope, Audio Level Meter, Video Info status & Time code Display.

- Double

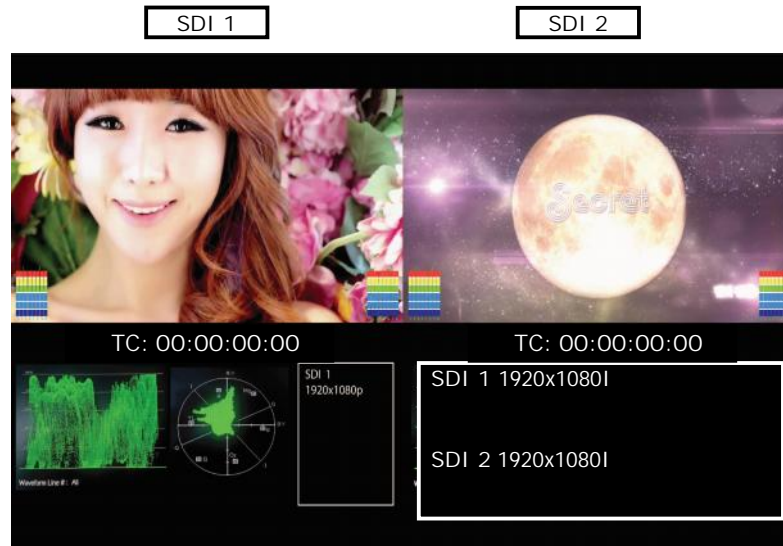

- SDI 1, 2 & WAVEFORM & Vector Scope & Audio Level Meter, Video Info status & Time code Display.

- Y-Waveform + Vector Scope Trans



- WAVEFORM & Vector Scope Trans.

- Vector Color

- Vector color: Select 100% or 75%

- Line Select

- Select line WAVEFORM & Vector Scope display.

- Line select: 1~540



- Line #  
-line select
- Line Display  
-off/on/5 sec
- Dual Link Mode (SDI only)  
-Dual Link Mode select. (Auto/Off/RGB444/YCbCr444/YCbCr422/Progressive)
- Set ID & Active Set ID  
- Set ID is required for remote control. Set ID range (01~99).

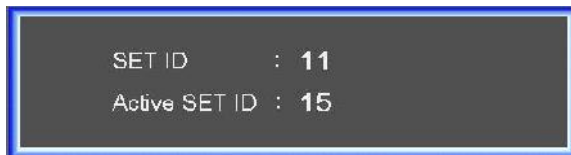

- Set Active SET ID number to enable Remote control.
- Active SET ID is the total number of monitors you are planning to control.

### 13. PIP (Picture In Picture)

- Display two programs or sources at the same time. And set up PIP size and position.

- PIP ON/OFF



- Control PIP function On/Off.

- Input Source

- PIP input source verity of selections.
- Analog (Composite1, 2, 3, Y.Pb.Pr, GBR, PC) inputs + Digital (DVI, HDMI) + SDI (SDI1, SDI2) inputs
- SDI + SDI input PIP
- Ex) AV + S-Video (X), DVI + SDI (O), PC + DVI (O), SDI1+SDI2 (O)



- Aspect Ratio

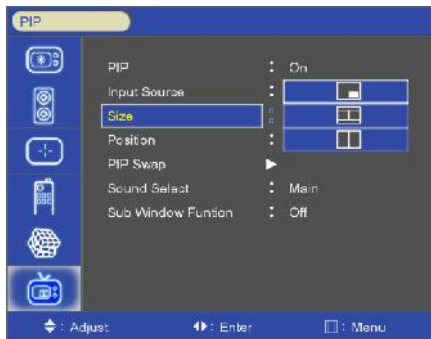

- Choose PIP size



PIP Small



PIP1



PIP2

- Position

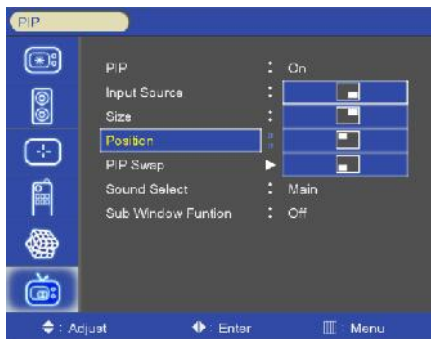

- Choose the PIP position

- PIP Blend



-Blend setting

- PIP Swap

- Using Swap option, you can swap the program or source.

- Audio Select

- Using Audio Swap option, you can swap the audio of the program or source.

- Sub Window Function

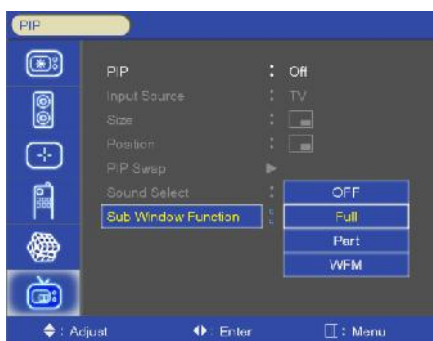

- Full Sub Window: Display the same full image on POP1 screen.

- Part Sub Window: images are scaled to fit the screen in half.
- FULL, Part function is only available with Digital input (SDI1, SDI2, DVI, HDMI)



Sub Window Full



Sub Window Part

# 14. OSD TREE

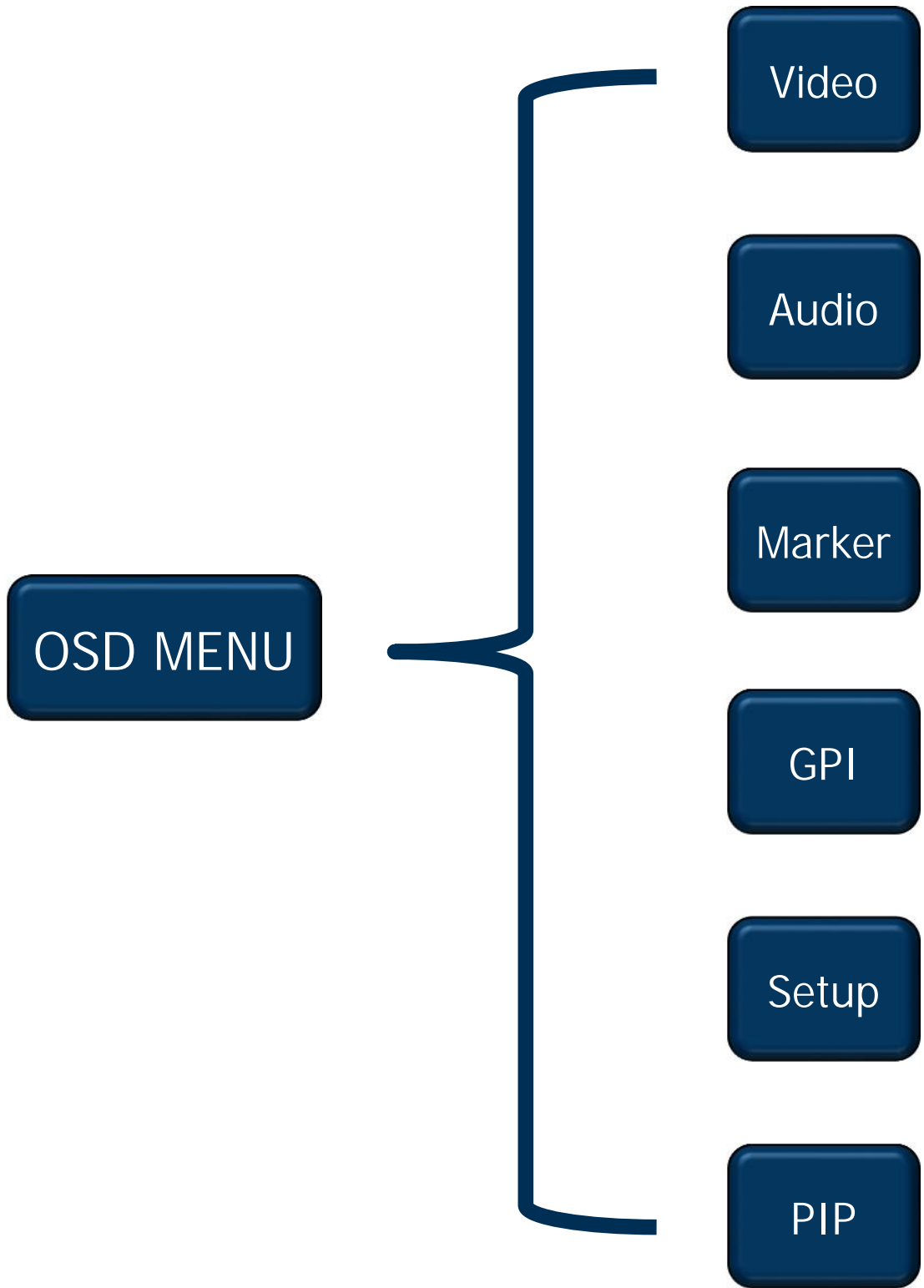

1) *Video*

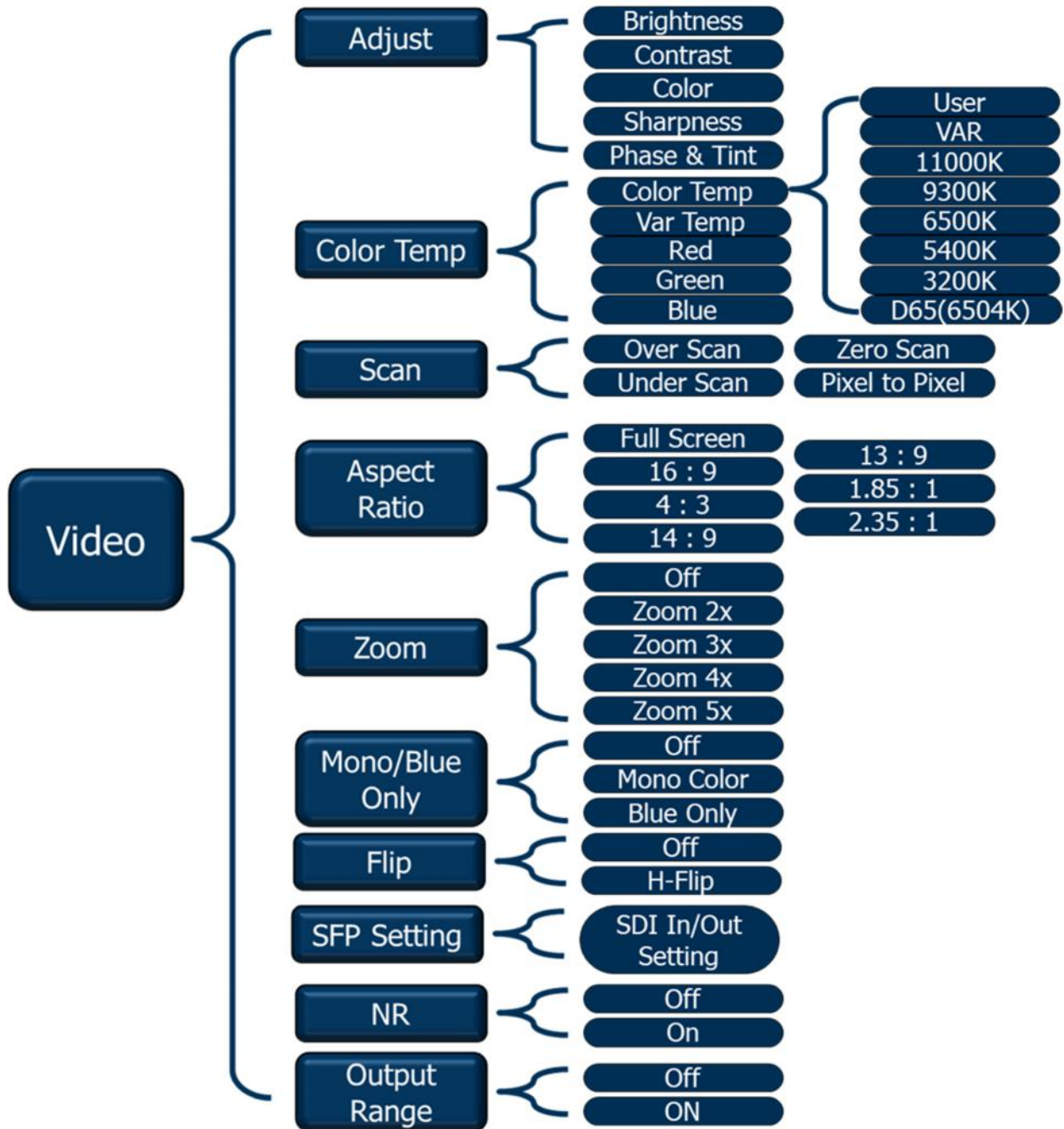

2) *Audio*

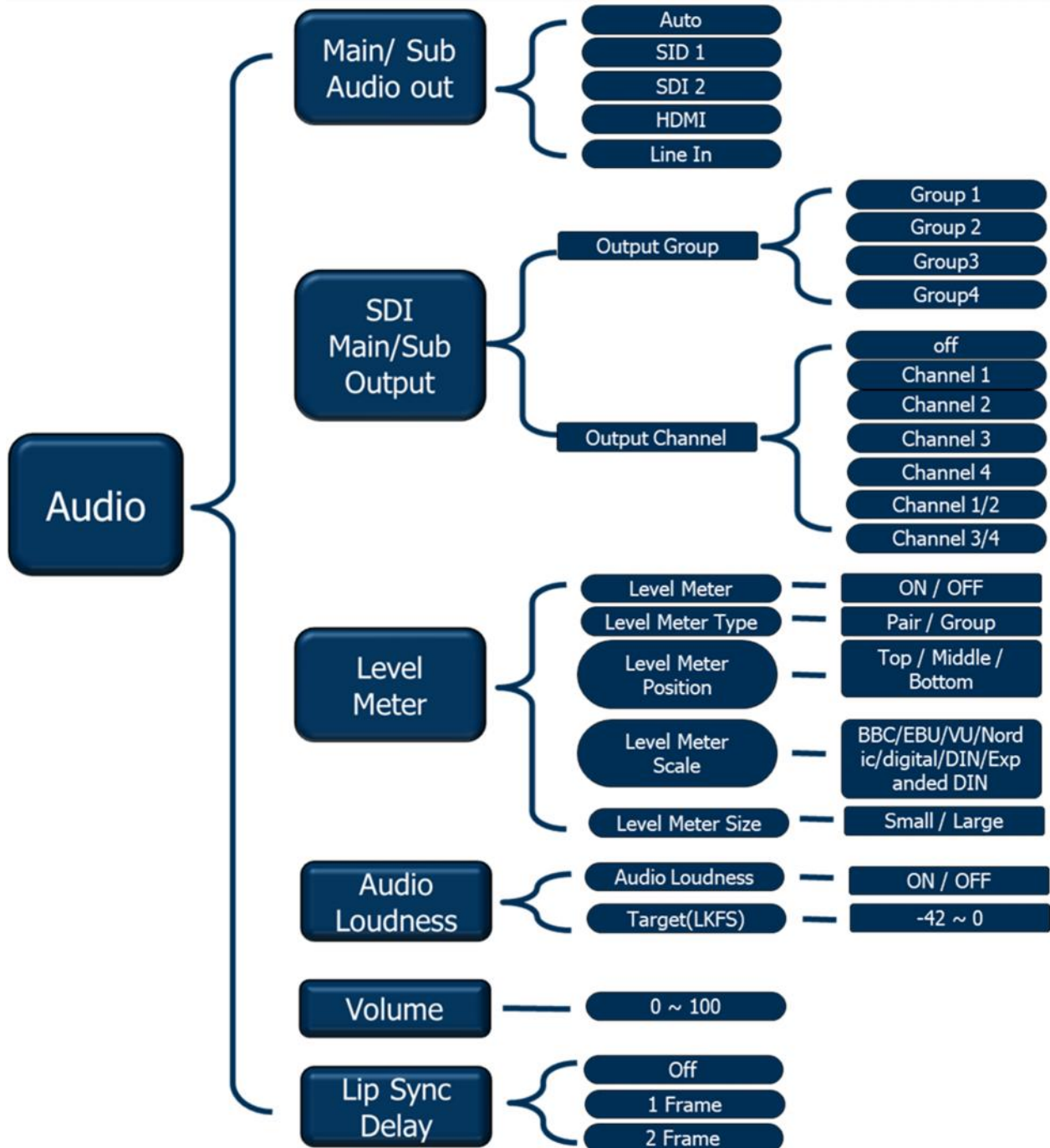



3) *Marker*

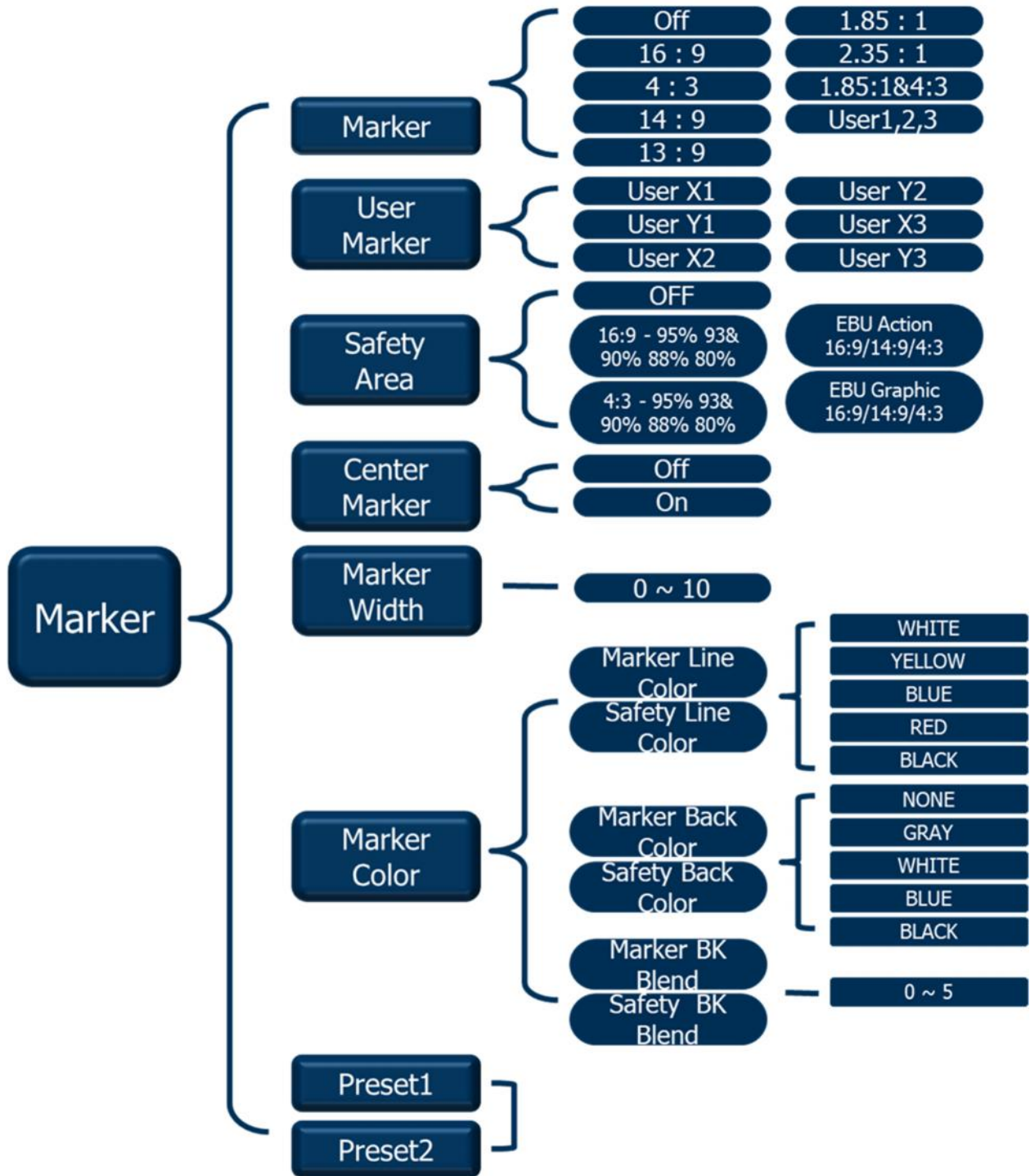

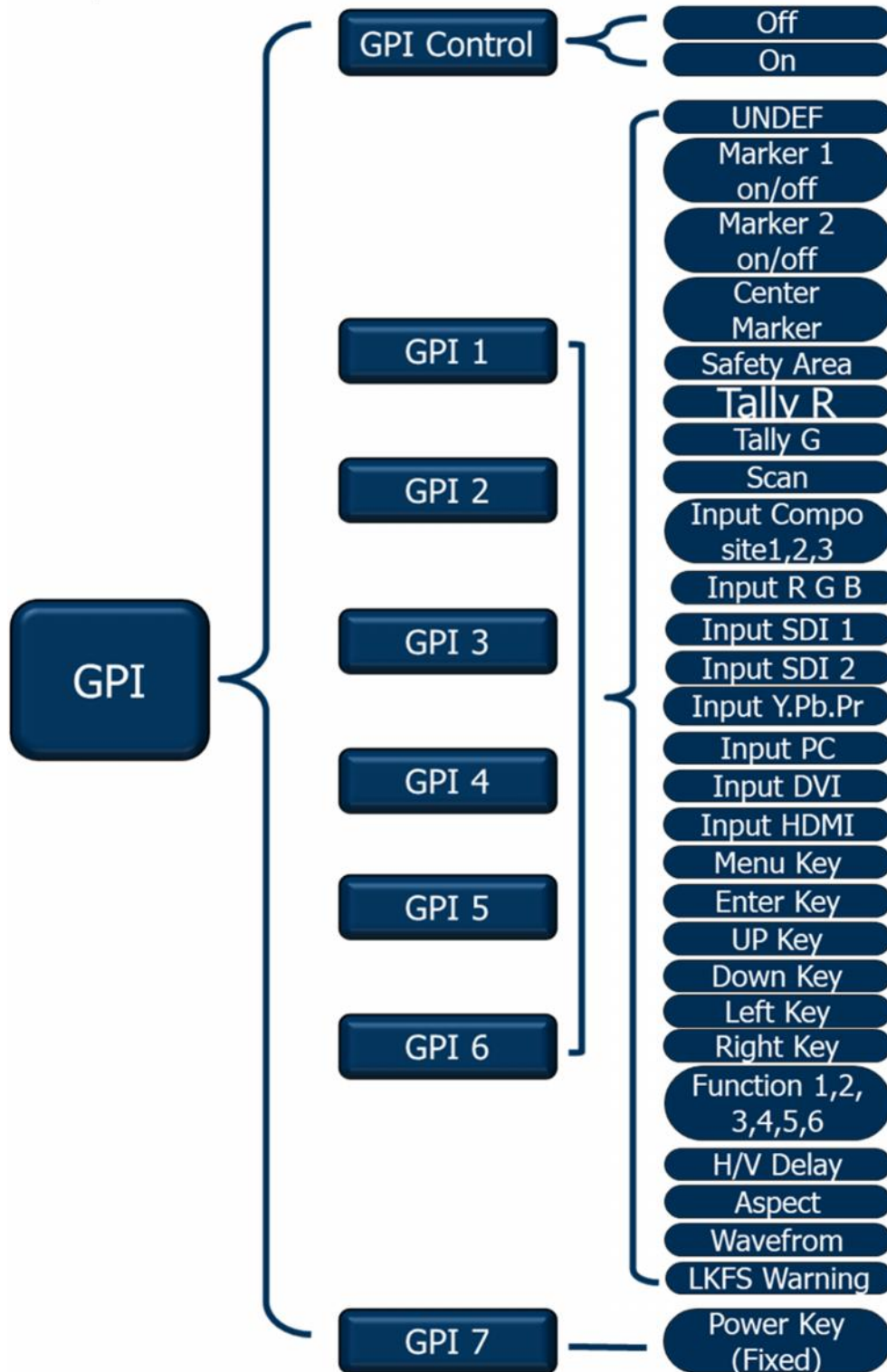
4) *GPI*



5) Setup

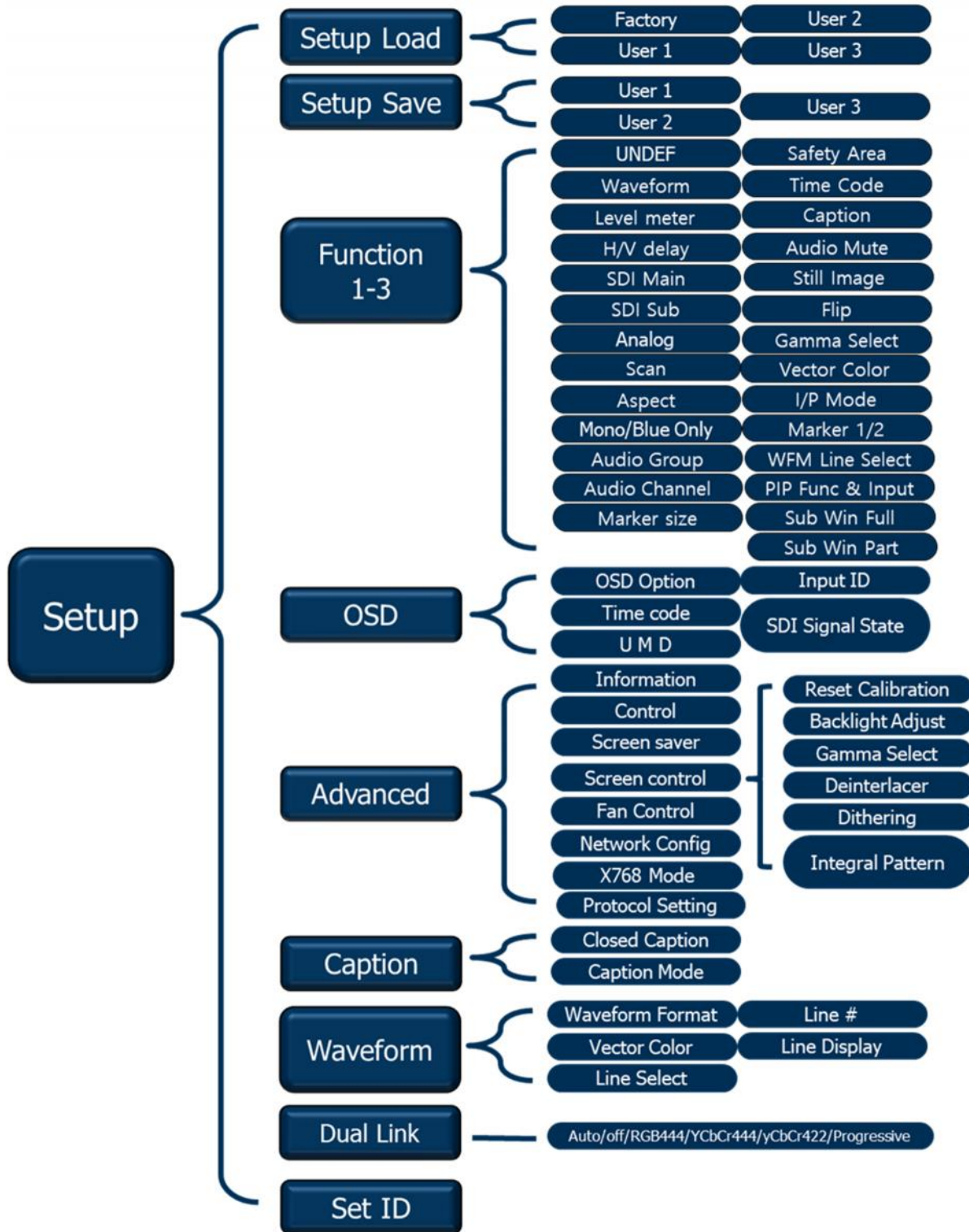

6) *PIP*

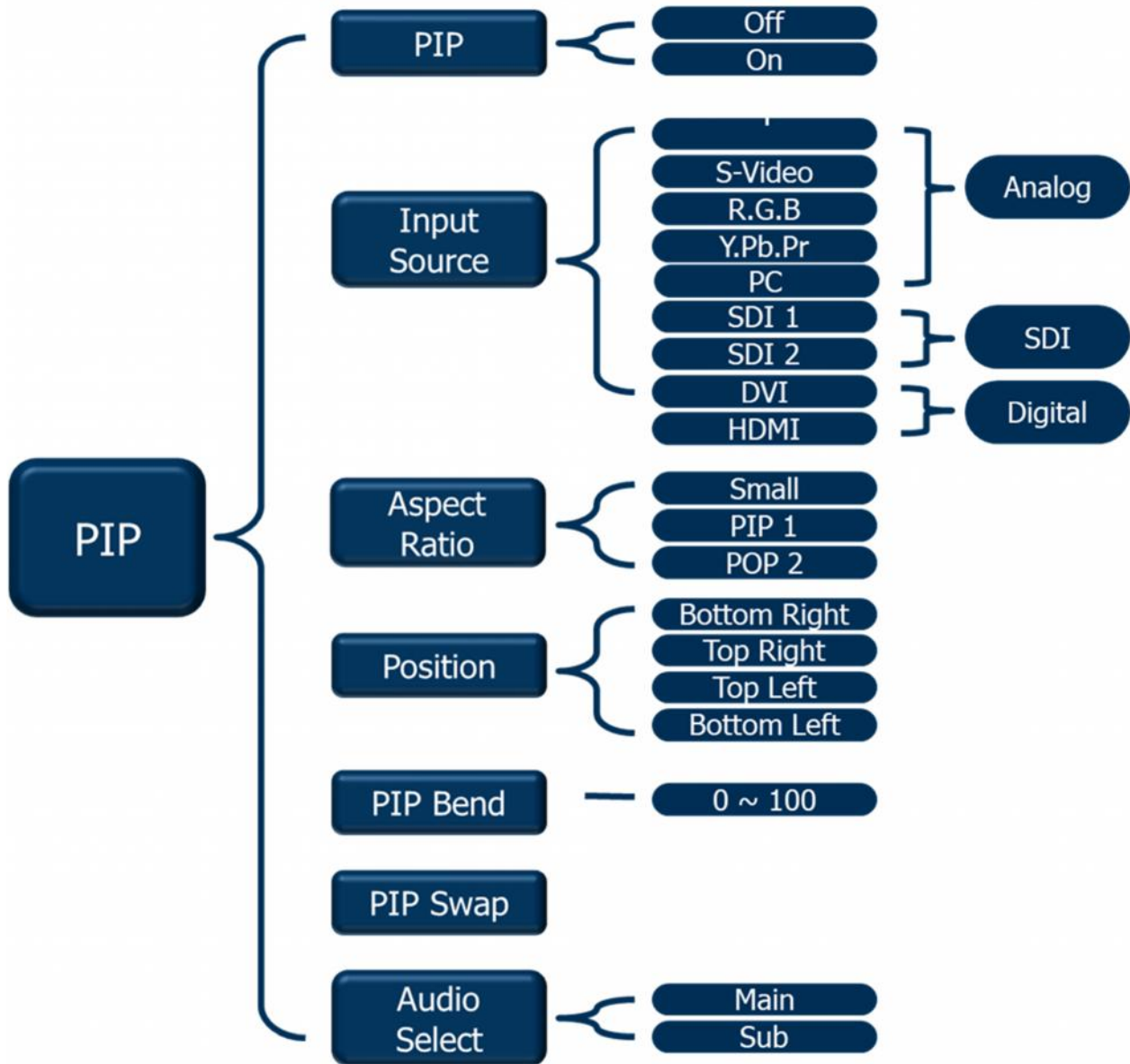

## 15. Mechanical Dimension

### 1. SFP-317-H

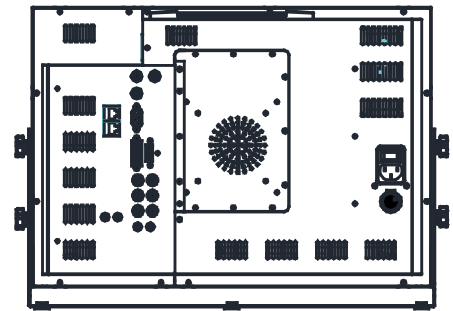
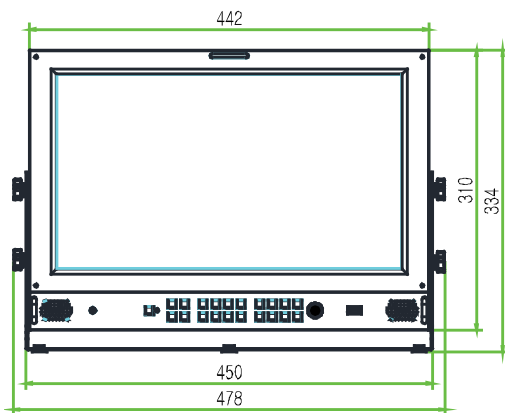
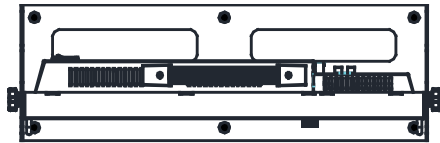

VESA HOLE : 75 x 75 mm, 100 x 100 mm

### 2. SFP-321-H

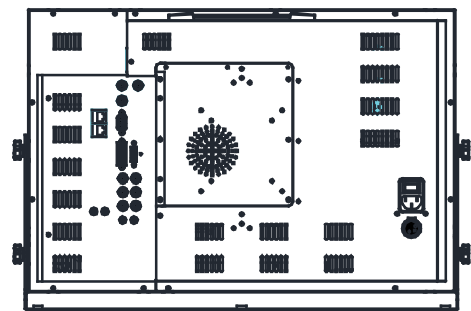
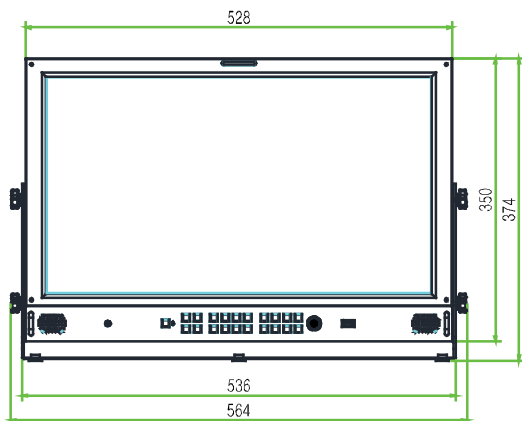

VESA HOLE : 75 x 75 mm, 100 x 100 mm

3. **SFP-324-H**

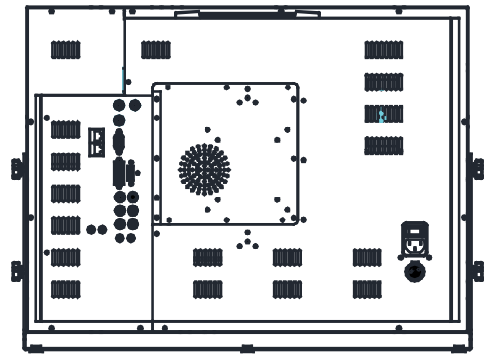
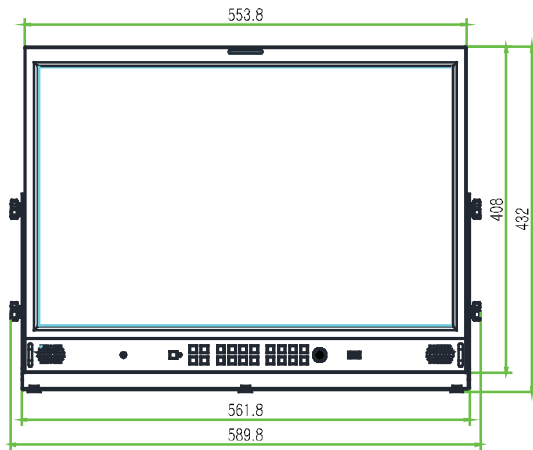
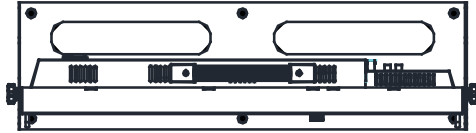

VESA HOLE : 75 x 75 mm, 100 x 100 mm

# plura®

[www.plurainc.com](http://www.plurainc.com)

[www.plurasfp.com](http://www.plurasfp.com)

U.S.A. . Germany . U.A.E. . S.Korea . Mexico