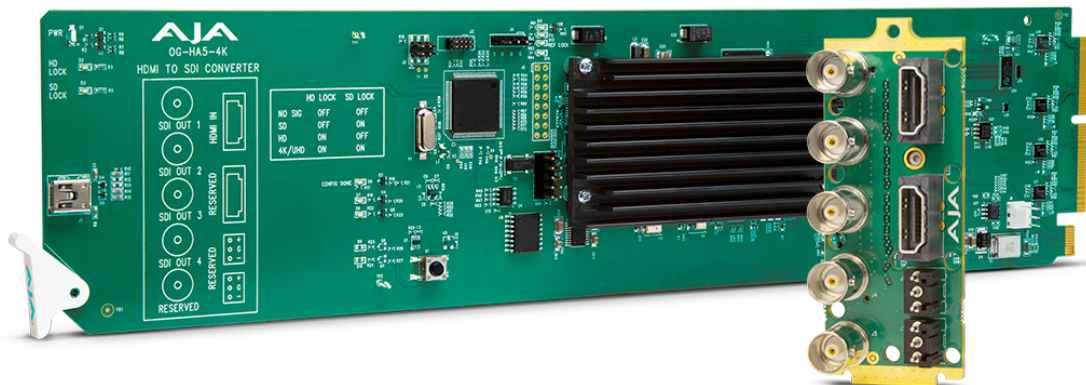


# OG-HA5-4K

## HDMI to SDI Converter



## Installation and Operation Guide

Version 1.0  
Published November 6, 2018



# Notices

---

## Trademarks

---

AJA® and Because it matters.® are registered trademarks of AJA Video Systems, Inc. for use with most AJA products. AJA™ is a trademark of AJA Video Systems, Inc. for use with recorder, router, software and camera products. Because it matters.™ is a trademark of AJA Video Systems, Inc. for use with camera products.

CION®, Corvid Ultra®, Io®, Ki Pro®, KONA®, KUMO®, ROI® and T-Tap® are registered trademarks of AJA Video Systems, Inc.

AJA Control Room™, KiStor™, Science of the Beautiful™, TruScale™, TruZoom™, V2Analog™ and V2Digital™ are trademarks of AJA Video Systems, Inc.

All other trademarks are the property of their respective owners.

## Copyright

---

Copyright © 2018 AJA Video Systems, Inc. All rights reserved. All information in this manual is subject to change without notice. No part of the document may be reproduced or transmitted in any form, or by any means, electronic or mechanical, including photocopying or recording, without the express written permission of AJA Video Systems, Inc.

## Contacting AJA Support

---

When calling for support, have all information at hand prior to calling. To contact AJA for sales or support, use any of the following methods:

Telephone	+1.530.271.3190
FAX	+1.530.271.3140
Web	<a href="https://www.aja.com">https://www.aja.com</a>
Support Email	<a href="mailto:support@aja.com">support@aja.com</a>
Sales Email	<a href="mailto:sales@aja.com">sales@aja.com</a>

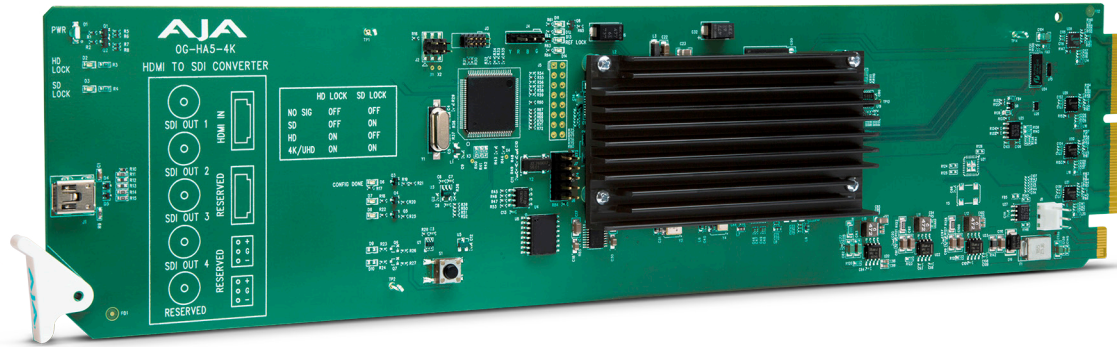
# Contents

---

Notices . . . . .	2
Trademarks . . . . .	2
Copyright . . . . .	2
Contacting AJA Support . . . . .	2
<b>Chapter 1 – Introduction . . . . .</b>	<b>4</b>
Overview . . . . .	4
Default Operation . . . . .	4
Features . . . . .	4
Block Diagram . . . . .	5
I/O Connections . . . . .	6
Signal Indicators on the OG-HA5-4K Card . . . . .	6
Signal Indicators in the DashBoard Control System . . . . .	7
User Controls . . . . .	8
DashBoard Control System . . . . .	8
openGear and AJA . . . . .	9
Installation . . . . .	9
Summary . . . . .	9
Unpacking . . . . .	9
Rear OG-HA5-4K Card Installation . . . . .	9
Front OG-HA5-4K Card Installation . . . . .	10
Cabling . . . . .	12
<b>Chapter 2 – Operation . . . . .</b>	<b>13</b>
Using the DashBoard Control System . . . . .	13
Requirements . . . . .	13
Control Interface Basic Components . . . . .	13
Basic Tree View of Frames and Cards . . . . .	14
Card Information and Status . . . . .	14
Parameter Controls . . . . .	14
Card Tab Screen . . . . .	15
Status Tab Screen . . . . .	16
HDR Tab Screen . . . . .	17
Input Tab Screen . . . . .	19
Output Tab Screen . . . . .	20
Audio Tab Screen . . . . .	22
Setup Tab Screen . . . . .	22
Uploading New Software . . . . .	23
Rebooting . . . . .	25
<b>Appendix A – Specifications . . . . .</b>	<b>27</b>
OG-HA5-4K Tech Specs . . . . .	27
<b>Appendix B – Safety and Compliance . . . . .</b>	<b>30</b>
<b>Warranty and Liability Information . . . . .</b>	<b>39</b>
Limited Warranty on Hardware . . . . .	39
Limitation of Liability . . . . .	40
Governing Law and Language; Your Rights . . . . .	40
<b>Index . . . . .</b>	<b>41</b>

# Chapter 1 – Introduction

---



## Overview

---

AJA's OG-HA5-4K is an openGear card that provides high-quality conversion of HDMI v2.0 to 4K SDI with 4 x 3G-SDI outputs. OG-HA5-4K allows conversion of HDMI video from various sources, including DSLR's, mirrorless cameras, action cameras, or prosumer 4K video cameras to 4K SDI for use in professional workflows. The OG-HA5-4K outputs SDI video with the same format and frame rate as the incoming HDMI video. The OG-HA5-4K also supports both Square Division and Two Sample Interleave output mapping.

Designed for use in high-density openGear 2RU frames, including AJA's OG-X-FR 2RU frame, the OG-HA5-4K is capable of communicating with Ross Video's DashBoard Control System. DashBoard runs on Windows®, macOS®, and Linux®, providing convenient, industry-standard configuration, monitoring and control of the openGear architecture over a PC or local network.

## Default Operation

---

The OG-HA5-4K auto configures to the connected HDMI input. The auto-configure function identifies the connected input and outputs the equivalent SDI format.

An SD or HD output signal uses only BNC SDI Out 1, and the remaining BNC output connectors are inactive by default. However, the DA function accessible with DashBoard allows replication of the output signal on those extra output BNCs.

## Features

---

- openGear compatible card (requires 2 slots, rear card included)
- Use with openGear 2RU frames
- Controlled by DashBoard network control software
- HDMI to 4K/HD/SD-SDI (see "[Appendix A – Specifications](#)" on page 27 for a complete list of supported inputs).
- HDMI 2.0 support including:
  - 4:2:2/4:4:4/4:2:0 YCbCr

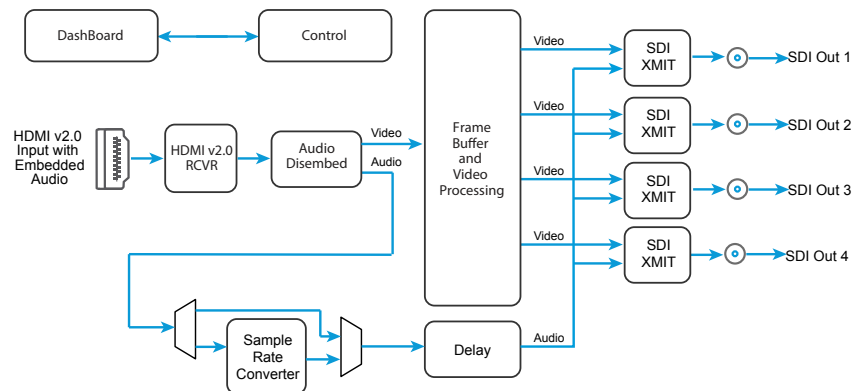
- 4:4:4 RGB
- 8, 10, or 12 bit (HFR 4K/UltraHD 4:4:4 limited to 8 bit)
- 2 or 8 channels of embedded audio
- SDI support including:
  - SMPTE 425 Level A and B
  - Quadrant or 2SI mapping
  - 4:2:2/4:4:4 YCbCr
  - 4:4:4 RGB
  - 10 bit
  - 8 channels of embedded audio
  - Pad/Crop between 4K and UHD
  - P to PsF conversion
  - DA Function
- Support for HDMI 2.0a
  - HDR Static Metadata Descriptors
- 5 year warranty

*NOTE: 3D is not supported in this converter.*

*NOTE: 720p 4:4:4 formats are not supported in this release.*

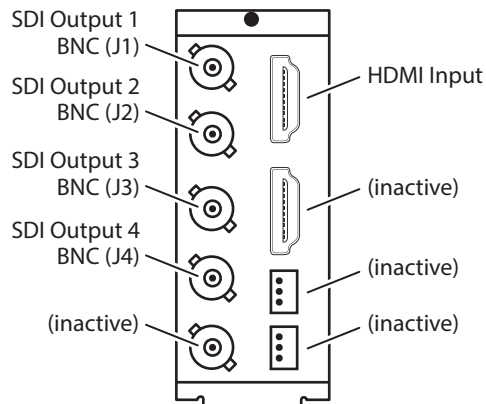
## Block Diagram

*Figure 1. OG-HA5-4K Converter, Simplified Block Diagram*



# I/O Connections

Figure 2. OG-HA5-4K Converter Connections



## Signal Indicators on the OG-HA5-4K Card

Located at the upper front area of the OG-HA5-4K card, the SD Lock and HD Lock LEDs work in combination to indicate the type of signal detected by the HDMI input.

Figure 3. LED lights on card

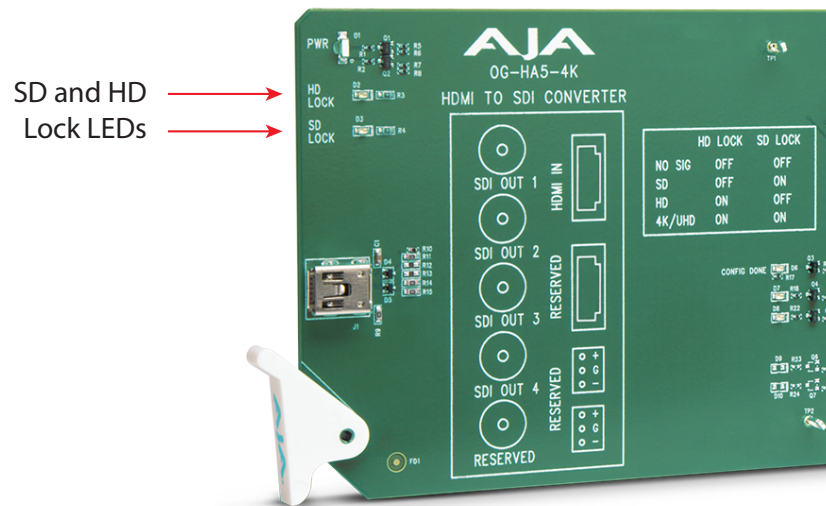


Table 1. The meaning of the behaviors of the lights for the SD and HD Lock LEDs

Signal Detected	HD Lock Light	SD Lock Light
No Signal	Off	Off
SD Signal	Off	On
HD Signal	On	Off
4K/UltraHD Signal	On	On

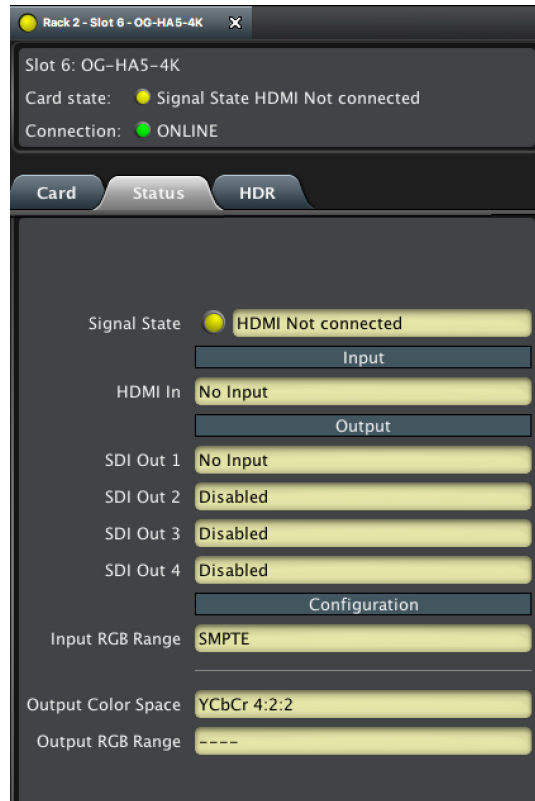
# Signal Indicators in the DashBoard Control System

## Yellow Card State Alarm

When the signal is either not present or is not locked, the DashBoard Control System shows a yellow Card State alarm. Additionally, under the Status tab, the Signal State is reported as "HDMI Not Connected," and the HDMI In signal is shown as "No Input."

If the OG-HA5-4K does not recognize an input signal, the HDMI In field may display "RDE! pFRDE!"

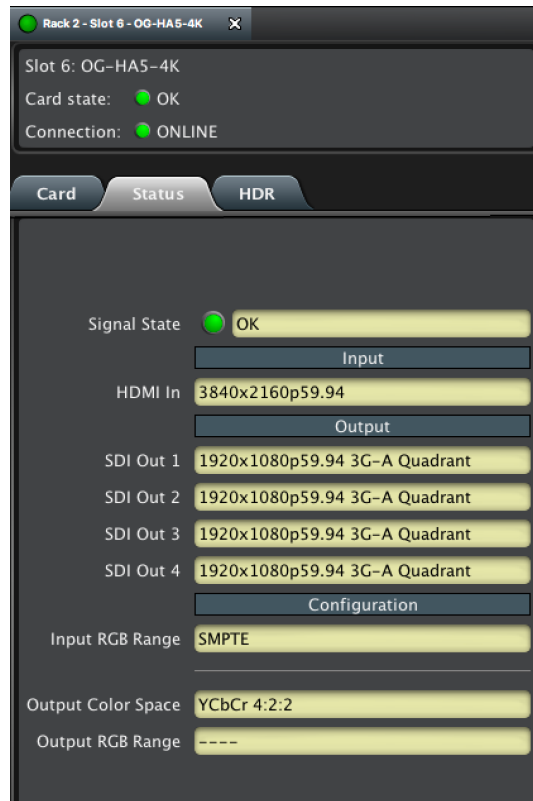
Figure 4. Signal is not present or not locked



## Green Card State Alarm

When a signal is present and locked, the DashBoard Control System shows a green Card State and a green Connection under the Status tab. The SDI Out Signal is also indicated (for example, "1920x1080p59.94 3G-A Quadrant").

Figure 5. Signal is present and locked



## User Controls

The OG-HA5-4K can be used right out of the box for many applications, since it is designed to recognize inputs and perform standard actions automatically. However, you can also manually configure the OG-HA5-4K using remote configuration through the DashBoard Control System for an openGear Frame.

## DashBoard Control System

The DashBoard Control System, created by Ross Video, provides a control interface between Windows, macOS and Linux computers and the cards installed in an openGear frame. DashBoard operates through TCP/IP communication and requires an Ethernet connection between the controlling computer and an openGear frame.

For details about acquiring and using the DashBoard Control System, refer to ["Using the DashBoard Control System" on page 13.](#)



## openGear and AJA

---

openGear is an open-architecture, modular frame system designed by Ross Video and supported by a diverse range of terminal equipment manufacturers, including AJA. Ross Video manufactures the frames, power supplies and network cards for openGear. AJA is a reseller of the openGear frames.

AJA Video is a leading manufacturer of video interface technologies, converters, digital video recording solutions and professional cameras, bringing high-quality, cost-effective products to the professional, broadcast and post-production markets. AJA products, including openGear cards, are designed and manufactured at our facilities in Grass Valley, California.

## Installation

---

### Summary

---

Installing an OG-HA5-4K card into an OG-X-FR openGear frame consists of the following steps:

- Install the Rear Panel onto the back of the frame corresponding to the slot pair you will be using for the OG-HA5-4K card.
- Insert the OG-HA5-4K card into the frame in the right (even numbered) slot of the pair.
- Connect the BNC, HDMI and audio cabling to the Rear Panel.



**ESD Susceptibility** - Static discharge can cause serious damage to sensitive semiconductor devices. Avoid handling circuit boards in high static environments such as carpeted areas, and when wearing synthetic fiber clothing. Always exercise proper grounding precautions when working on circuit boards and related equipment.

### Unpacking

---

Unpack each openGear product you received from the shipping container and ensure that all items are included. If any items are missing or damaged, contact your sales representative or AJA directly.

### Parts List

---

<i>Quantity</i>	<i>Description</i>
1	OG-HA5-4K Front Card in ESD bag
1	5 BNC, 2 HDMI, 2 Audio Rear Card

### Rear OG-HA5-4K Card Installation

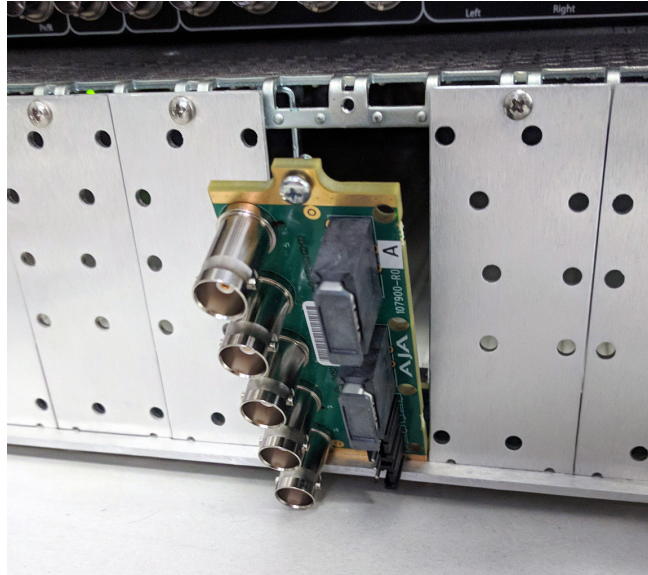
---

1. Ensure that the frame is properly installed.
2. Locate the card frame slot on the rear of the openGear frame into which you wish to install the openGear card.

*NOTE:* An OG-HA5-4K card occupies two slots in the frame.

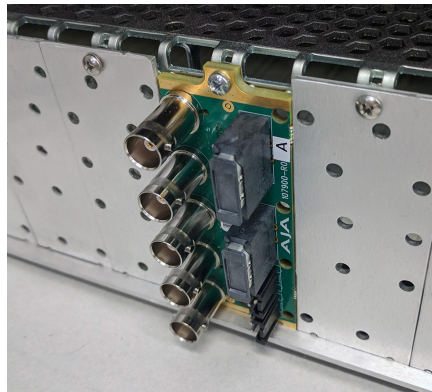
3. Using a Phillips screwdriver, unscrew the top screw from the desired blank rear plate and remove the rear plate.
4. Seat the bottom of the Rear Card in the seating slot at the base of the frame back plane.

*Figure 6. Rear Card Inserting Into Frame Seating Slot*



5. Align the top screw of the Rear Card with the screw hole on the top edge of the frame back plane.
6. Ensure the Rear Card aligns with the desired card slot before tightening the screw.
7. Using a Phillips screwdriver, fasten the Rear Card to the frame back plane. Do not over tighten.

*Figure 7. Rear Card Inserted Into Frame Seating Slot*



8. Ensure proper frame cooling and ventilation by having all rear frame slots covered with rear modules or blank metal plates if plates are not pre-installed.

## Front OG-HA5-4K Card Installation

1. Open the openGear frame door as follows:
  - A. Gently pull the side door tabs towards the center of the door, releasing the door from the frame.
  - B. Using both hands, pull the door towards you. The door extender arms prevent the door from falling.
2. Locate the Rear Card you installed as described above. The interior slot number is dependent on the slot combinations into which you installed the Rear Card. This allows adequate spacing to avoid damaging the card, the cards installed in the neighboring slots, or both.

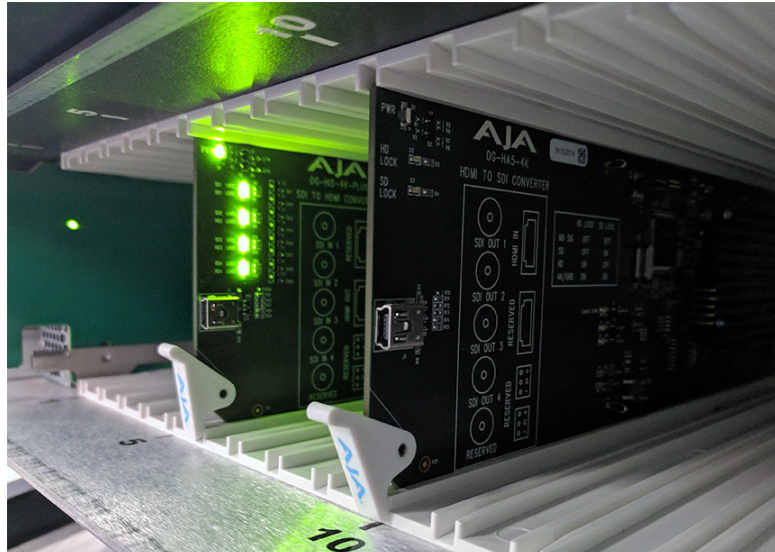
3. Hold the card by the edges and carefully align the card edges with the rails inside the frame. The slots are numbered starting from the left-most slot when facing the frame front.

*IMPORTANT: OG-HA5-4K cards are installed into the right (even numbered) slot of the pair in order to connect with the rear panel.*

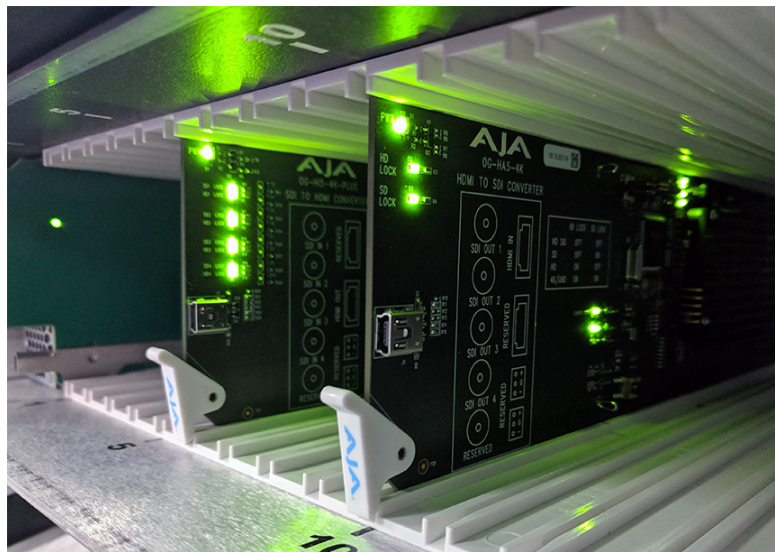
4. Fully insert the card into the frame until the card is properly seated in the Rear Card. There are two stages to inserting the card:
  - A. After you feel the card's first click, its position in the frame will resemble the photograph below in [Figure 8](#).
  - B. Next, press against the white plastic tab again until you feel the second click. The card's position will resemble the photograph below in [Figure 9](#).

*NOTE: Some cards require more pressure than others to be fully inserted. Make sure that the plastic tab at the bottom of the front edge of the card is completely upright. If it is tilting forward, the card is not yet fully inserted.*

*Figure 8. The card is not yet fully inserted, as indicated by the white plastic tab tilting forward.*



*Figure 9. The white plastic tab is upright, indicating that the card is now fully inserted.*



5. Close the frame door as follows:
  - A. Slide the door into the frame.
  - B. Pull and release the door tabs to ensure the frame door is securely locked to the frame.

## Cabling

---

Refer to "[I/O Connections](#)" on page 6 to identify the input and output signal connectors.

# Chapter 2 – Operation

---

## Using the DashBoard Control System

---

The DashBoard Control System is available as a free download from the openGear DashBoard Software Download webpage:

[http://www.opengear.tv/dashboard-software/#support\\_box](http://www.opengear.tv/dashboard-software/#support_box)

Ross Video offers comprehensive documentation that covers the extensive capabilities of the DashBoard Control System:

<https://www.rossvideo.com/support/product-documentation/dashboard/>

This AJA OG-HA5-4K manual addresses only those essential aspects of the DashBoard Control System needed to control the OG-HA5-4K card.

## Requirements

---

The DashBoard Control System requires the following components:

- openGear frame with a Frame Controller card
- Ethernet connection between the controlling computer and the openGear frame

*NOTE: The openGear frame ships from AJA with the MFC-8322-S Frame Controller card for controlling the new AJA DashBoard cards. The openGear frame also supports the MFC-0G3-N Advanced Networking Frame Controller card, which can be used to control compatible OG cards.*

DashBoard automatically discovers openGear and DashBoard Connect devices, such as openGear frames and cards that are present and accessible on your network.

## Control Interface Basic Components

---

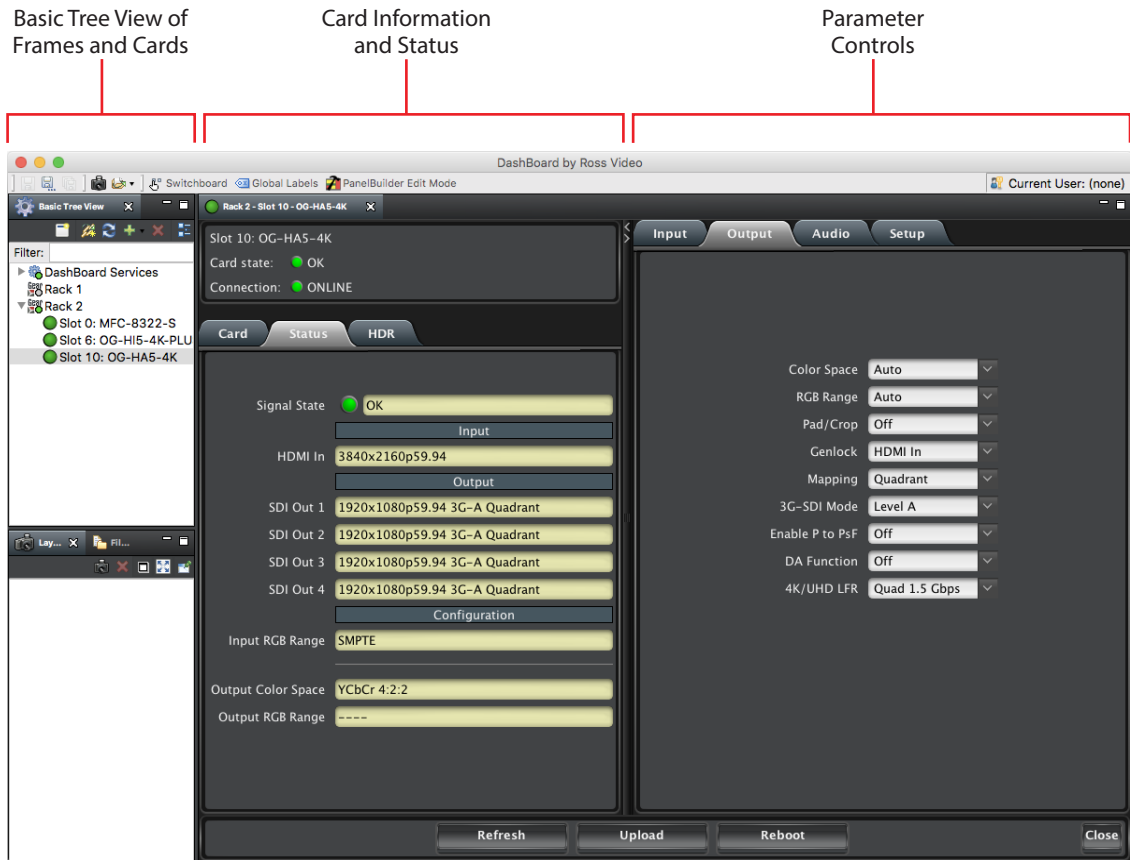
The basic components of the DashBoard Control System user interface consist of the basic tree view of frames and cards, the card information and status panel, and the parameter controls panel. These elements are shown below in [Figure 10](#).

The basic tree view of frames and cards shows the frames and cards that are discoverable by DashBoard on your network.

The card information and status panel, shown in the middle panel, display the basic status of the card currently selected in DashBoard.

The parameter controls panel shows the tabs and parameters that the selected card has available for configuration and control.

Figure 10. Main Sections of the DashBoard User Interface



## Basic Tree View of Frames and Cards

The basic tree view in the left column shows the frames and cards that are discoverable by DashBoard on your network.

## Card Information and Status

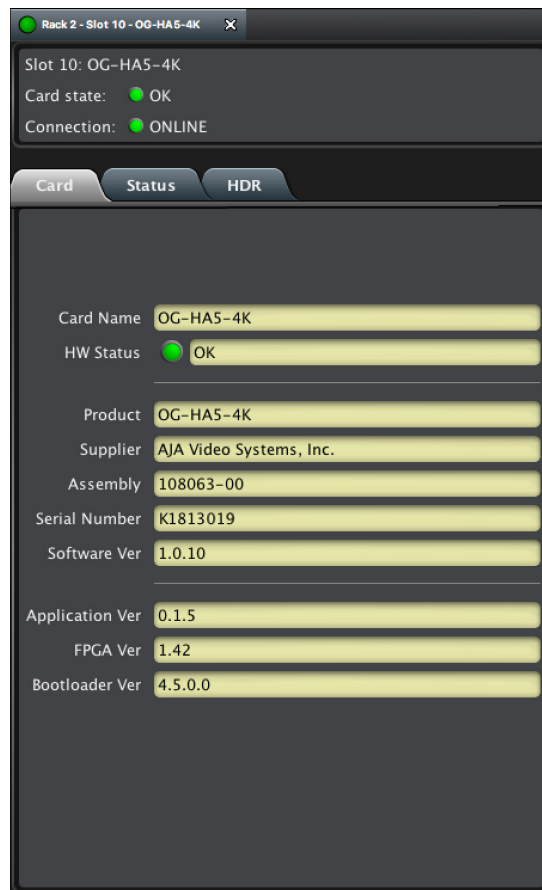
The card information and status panel, shown in the middle panel, displays the basic status of the card currently selected in DashBoard. The yellow fields in this panel indicate that they are read-only.

## Parameter Controls

The parameter controls panel on the right side of DashBoard shows the tabs and parameters that are configurable for the selected card. The white fields indicate that they can be written to, or modified.

## Card Tab Screen

Figure 11. OG-HA5-4K Card Tab Screen in Dashboard



The Card tab screen indicates the basic information about the card itself such as the card name, hardware status, serial number, software version and other items. This information is useful when calling AJA Support for service or technical support.

**Card Name** - This field allows you to give your specific OG card a name. This can be useful if you have multiple OG-HA5-4K cards in your installation so you can distinguish between them easily.

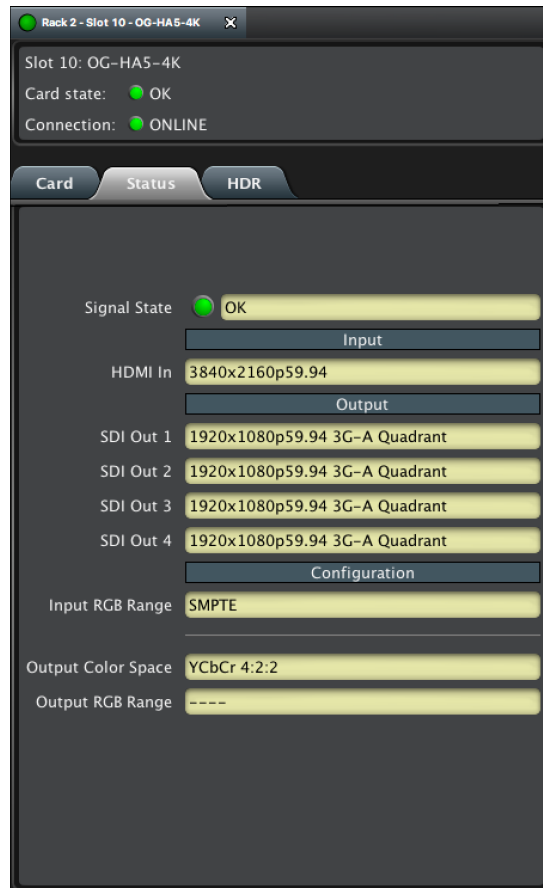
**Assembly** - This is the factory assembly number.

**Serial Number** - This is the factory set unique serial number of your OG card. If you ever call AJA Support for service, you may be asked for this number.



# Status Tab Screen

Figure 12. OG-HA5-4K Status Tab Screen in Dashboard

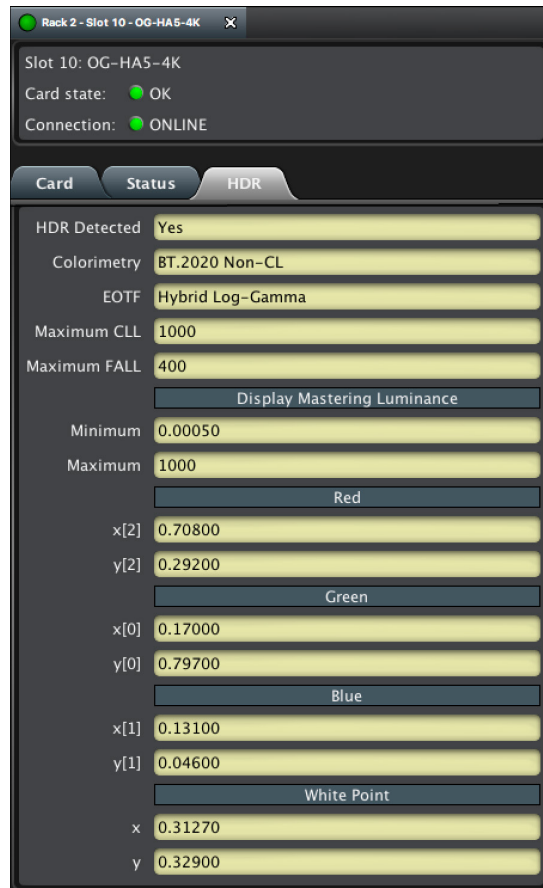


The Status tab provides detailed information on the current input and output signal status for the card. For example, the HDMI In status field reports whether the signal is connected. If the signal is not connected, the field would report **No Input**. Each SDI Out field reports the signal being generated by the card for each SDI output.



# HDR Tab Screen

Figure 13. OG-HA5-4K HDR Tab Screen in Dashboard



Click on the HDR tab to view the received High Dynamic Range (HDR) static metadata extensions settings.

The HDR tab displays whether a HDR Infoframe is being received on the HDMI input. If so, it decodes and presents the static metadata descriptors as defined in CTA-861.3 and HDMI v2.0a.

**NOTE:** The OG-HA5-4K HDR function does not modify the video data.

## HDR Detected

This field will report YES or NO to indicate whether a HDR Infoframe is being received.

- YES - HDR metadata is being received.
- NO - HDR metadata is not being received.

## Colorimetry

This field will report the Colorimetry value received from the AVI Infoframe. This information is always transmitted from an HDMI source, regardless of whether the HDR Infoframe is present.

Status values include the following:

- No Data
- Rec.601
- Rec.709

- BT.2020 Non-CL (non-constant luminance)
- BT.2020 CL (constant luminance)

## EOTF

---

This field will report the Electro-Optical Transfer Function (EOTF) value received from the HDR Infoframe.

Status values include the following:

- Trad Gamma SDR
- Trad Gamma HDR
- ST 2084 (SMPTE ST 2084)
- Hybrid Log-Gamma
- Reserved [4], not yet defined
- Reserved [5], not yet defined
- Reserved [6], not yet defined
- Reserved [7], not yet defined

## Maximum Content Light Level (CLL)

---

Represents the highest-value pixel component in an entire scene. It is determined by analyzing each frame of video, and can be determined in the post environment.

- Range: 1 cd/m<sup>2</sup> to 65535 cd/m<sup>2</sup>.
- Step size: 1 cd/m<sup>2</sup>.

## Maximum Frame Average Light Level (FALL)

---

Represents the maximum of frame-based average light levels taken over an entire scene, and can be determined in the post environment.

- Range: 1 cd/m<sup>2</sup> to 65535 cd/m<sup>2</sup>.
- Step size: 1 cd/m<sup>2</sup>.

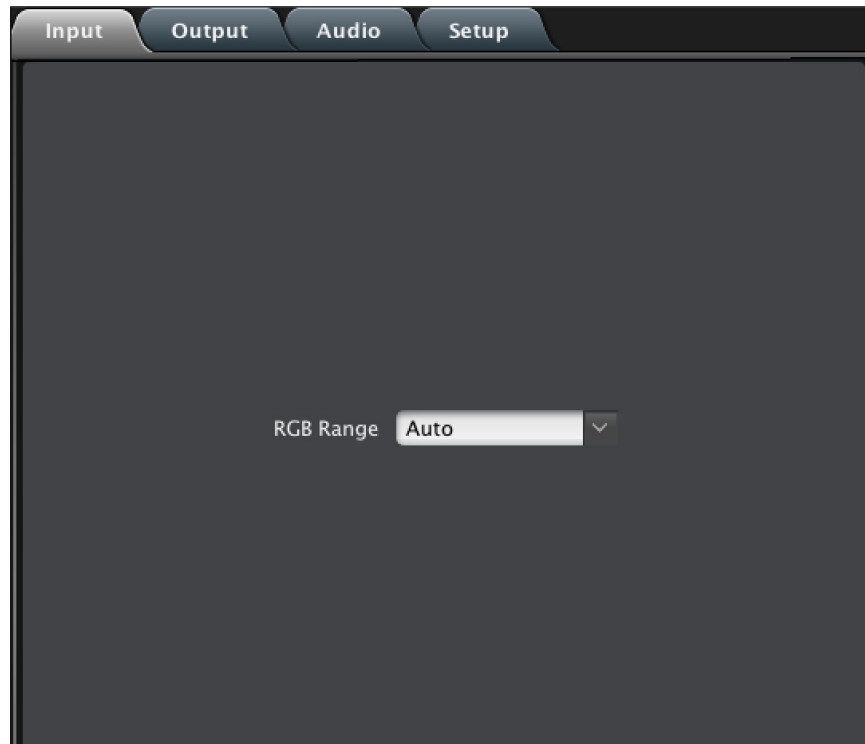
## Display Mastering Luminance

---

Represents the minimum and maximum Display Mastering Luminance values received in the HDR Infoframe.

- Minimum: Defines the floor of the SMPTE ST 2086 color volume (in the case of HDR) and is determined by the mastering environment.
  - Range: 0.00000 cd/m<sup>2</sup> to 1.00000 cd/m<sup>2</sup>.
  - Step size: 0.00002 cd/m<sup>2</sup>.
- Maximum: Defines the ceiling of the SMPTE ST 2086 color volume (in the case of HDR) and is determined by the mastering environment.
  - Range: 1 cd/m<sup>2</sup> to 65535 cd/m<sup>2</sup>.
  - Step size: 1 cd/m<sup>2</sup>.

## Input Tab Screen



### RGB Range

Selects the Input Video Color Range for RGB signals. Choose from:

- Auto (default)
- SMPTE
- Full

## Output Tab Screen



### Color Space

Selects the desired output video format. Choose from the following:

- Auto (default) Selects the video format based on the input video and the attached device's capabilities.
- YCbCr 4:2:2
- RGB 4:4:4
- YCbCr 4:4:4 (HFR 4K/UltraHD 4:4:4 limited to 8 bit)

### RGB Range

Selects the Color Range. Choose from the following:

- Auto - (default) Selects SMPTE vs Full based on incoming HDMI and setting of Input Color Range.
- SMPTE
- Full

### Pad/Crop

Selects pixel padding and cropping conversions between UltraHD and 4K formats. Choose from the following:

- Off - (default) No processing
- Pad - Add black pixels to the left and right sides of the raster to fill a wider aspect ratio (UltraHD to 4K, or HD to 2K).
- Crop - Crop pixels from left and right sides of the raster to fit a narrower aspect ratio (4K to UltraHD, or 2K to HD).

## Genlock

---

Select the genlock reference. Choose from the following:

- HDMI In (default) - Locks to incoming HDMI clock.
- Free Run - Locks to free running SDI internal clock.

## Mapping

---

Select the 4K/UltraHD mapping format:

- Quadrant (default) - Square Division
- 2SI - Two Sample Interleave

## 3G-SDI Mode

---

Selects the 3G SDI Video Mode. Choose from the following:

- Level A (default)
- Level B

## Enable P to PsF

---

Choose to convert incoming progressive format HDMI video to PsF SDI video.

- Off - (default) No conversion.
- On - Converts the video to PsF (if it is progressive format and low frame rate).

## DA Function

---

Choose to replicate the signal on any extra BNC outputs. An SD or HD input signal can be distributed to all four BNCs. A 4K/UHD LFR dual stream output signal can be distributed to each pair (1-2 and 3-4) of BNC output connectors.

- Off - (default) no video sent to any extra BNC outputs.
- On - For HD/SD signals, three additional copies of the signal are sent to the SDI Out 2, 3, and 4 BNCs. For dual link output signals, one additional copy of the signal is sent to the pair of SDI Out 3 and 4 BNCs.

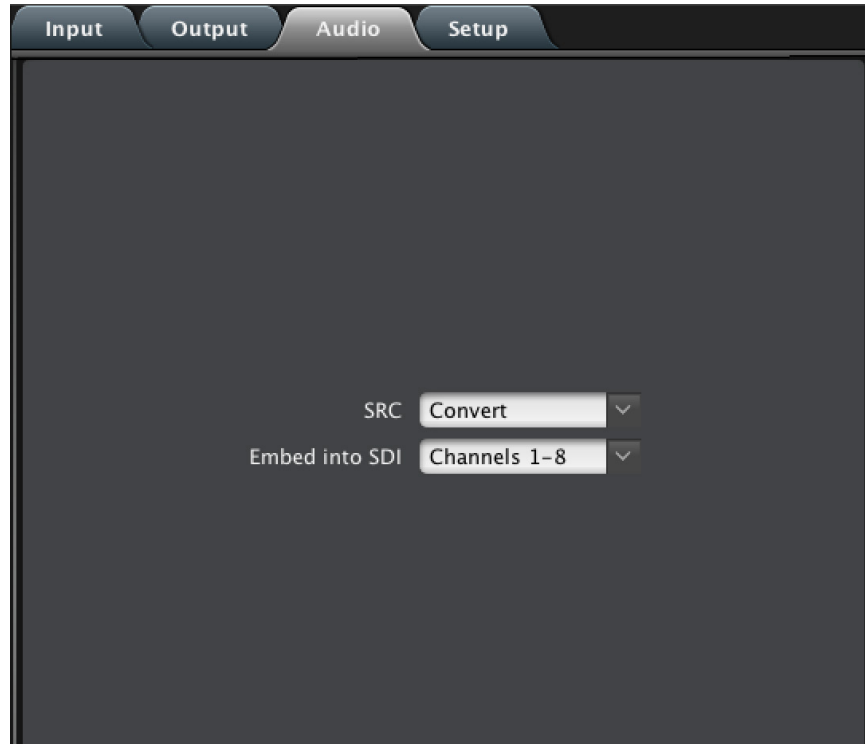
## 4K/UHD LFR

---

Controls how 4K/UltraHD Low Frame Rate video signals (23.98, 24, 25, 29.97, 30 fps) will be output, using all four BNC outputs (at 1.5 Gbps each), or two BNC outputs (at 3 Gbps each). Choose from the following:

- Quad 1.5 Gbps (default)
- Dual 3 Gbps

## Audio Tab Screen



### SRC

Choose the audio conversion to be performed on the incoming HDMI audio.

- Convert - HDMI audio will be sample rate converted, if necessary, to 24-bit/48 kHz audio.
- Pass Through - HDMI audio will be passed to the SDI embedded audio channels without conversion.

### Embed into SDI

Choose which set of SDI embedded audio output channels will receive up to eight channels of embedded audio received from the incoming HDMI signal. Audio is embedded only into the SDI 1 output link, which may be carried on one or more of the SDI Out BNC connectors, depending on configuration. Choose from the following:

- Channels 1-8
- Channels 9-16

In Quad output mode, the SDI embedded audio will only be sent out through the SDI Out 1 BNC.

In Dual output mode, when the DA function is Off, the audio will only be sent out through the SDI Out 1 BNC. When the DA Function is On, the audio will also be sent out through the SDI Out 3 BNC.

In Single output mode, when the DA function is Off, the audio will only be sent out through the SDI Out 1 BNC. When the DA Function is On, the audio will also be sent out through the SDI Out 2, 3, and 4 BNCs.

## Setup Tab Screen

Click on the Setup tab to view and make changes to the card name or to restore card settings to factory default values.

Figure 14. OG-HA5-4K Setup Tab Screen in DashBoard



**Card Name** - By default, this field is pre-populated with the card name OG-HA5-4K. You can change the card name by editing the text in the Card Name field.

**Factory Settings** - If you would like to revert the card settings to factory default values, click **Restore**.

## Uploading New Software

---

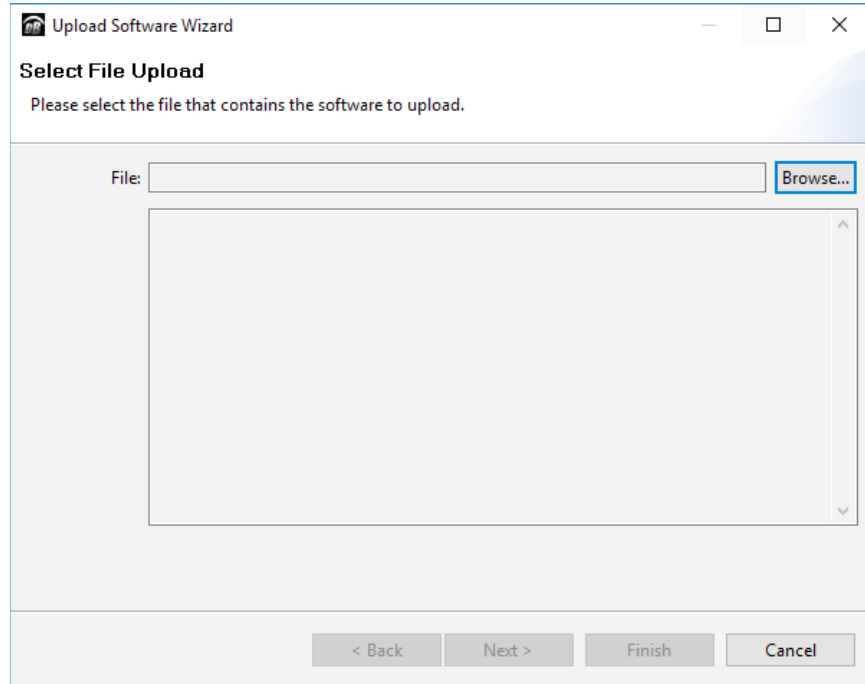
When available, you can upload updated software to the OG-HA5-4K through the DashBoard Control System by following the steps below.

### To Upload New Software

---

1. Check the AJA website for new software for your OG-HA5-4K. If new software is found, download it and uncompress the file archive (zip).
2. Click the Upload button in the lower panel of the DashBoard Control System to open the Upload Software Wizard.

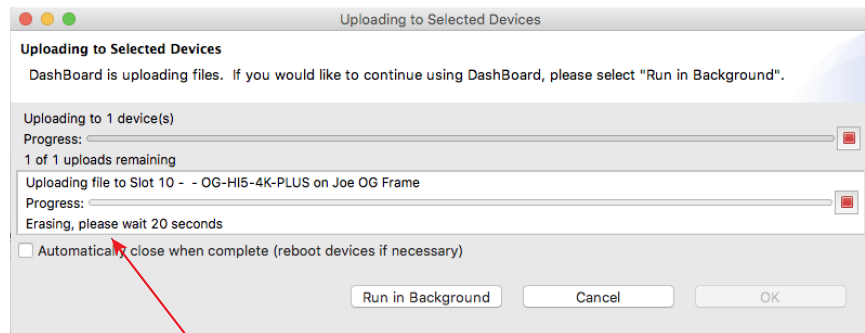
Figure 15. OG-HA5-4K Upload Software Wizard window in Dashboard



3. From the Upload Software Wizard window, select **Browse**.
4. Navigate to the location of the downloaded .bin file containing the software update. Select the .bin file, then select **Open**. The Upload Software Wizard window displays characteristics of the selected file for uploading.
5. Click **Finish**.

**NOTE:** Before the upload begins, Dashboard will erase the firmware on the card, taking approximately 20 seconds.

Figure 16. Note the message "Erasing, please wait 20 seconds"

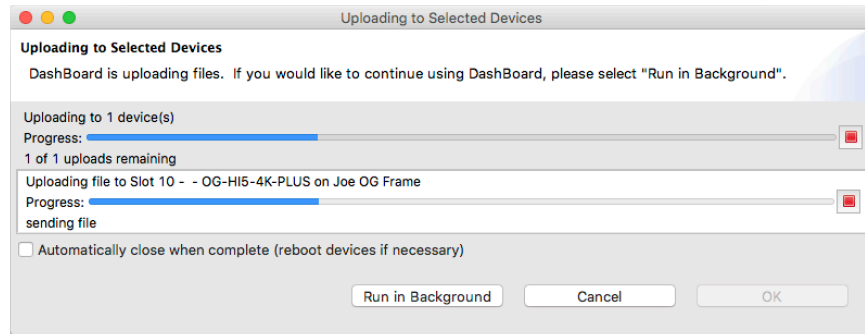


For the first 20 seconds,  
DashBoard is erasing the  
card's firmware.

After the erasing process has completed, the upload will begin, shown in the Uploading to Selected Devices window below.

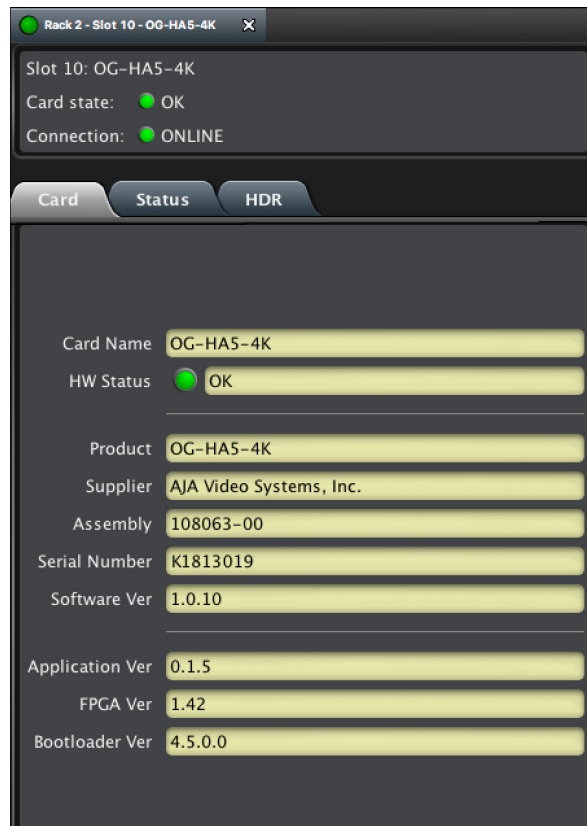


Figure 17. OG-HA5-4K Uploading to Selected Devices window in Dashboard



6. When the progress bar indicates that the uploading is finished and status indicates "Complete," click **OK**.
7. To verify the version of software or firmware currently installed on your card, select the Card tab from the center panel of Dashboard.

Figure 18. OG-HA5-4K Card Tab Screen in Dashboard indicating the currently installed software version.



## Rebooting

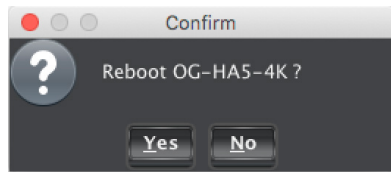
Rebooting is a standard function built in to the Dashboard Control System, and should only be performed if the board has become unresponsive.

**WARNING:** During a reboot, any card operations will be briefly interrupted, but will be restored once the reboot has completed.

## To Reboot the OG-HA5-4K

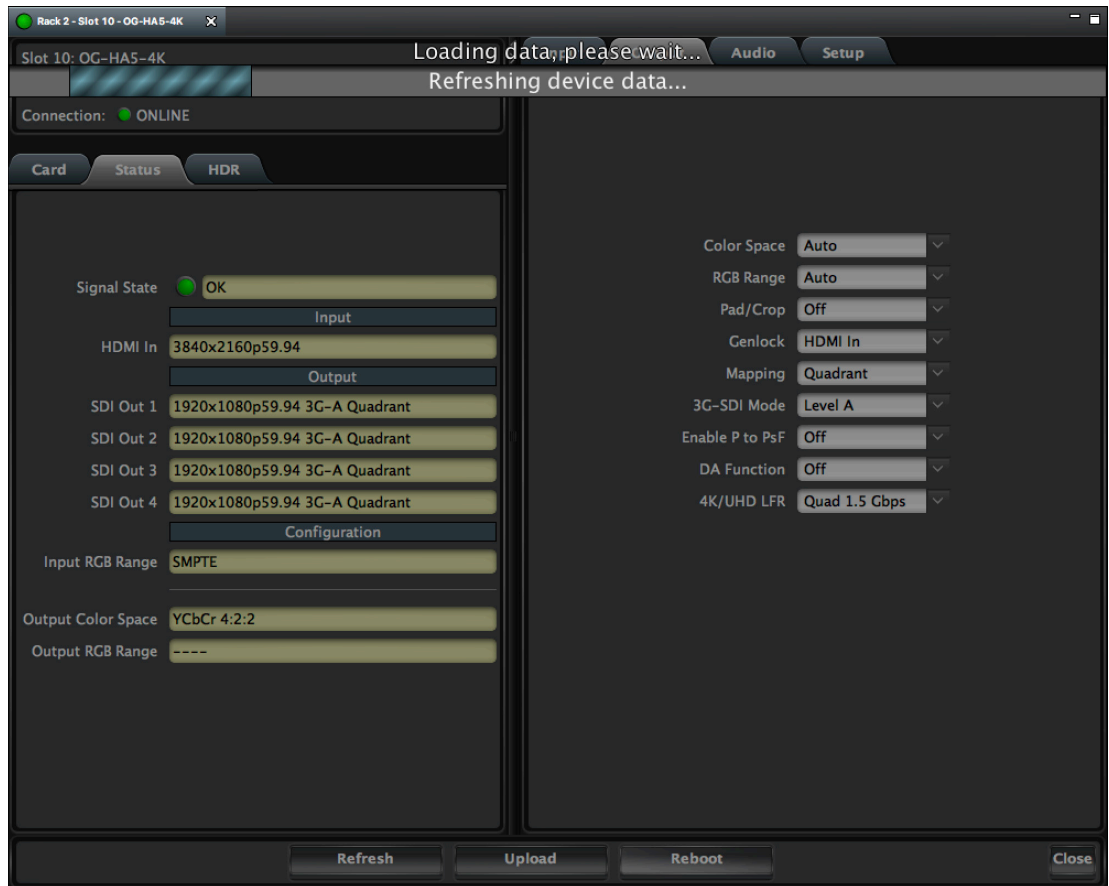
1. Click the Reboot button in the lower panel of Dashboard. The reboot confirmation message displays.

Figure 19. Reboot confirmation window



2. Click **Yes**. The message "Loading data, please wait. Refreshing device data" displays for a moment. The card will be offline for a few seconds, and any current operations will be interrupted.

Figure 20. The OG-HA5-4K briefly pauses operations while rebooting



3. Following a Reboot operation, the board configuration will return to the settings that were in place at the time of rebooting.

# Appendix A – Specifications

---

## OG-HA5-4K Tech Specs

---

### Video Formats

---

- (4K) 4096 x 2160p
- (UltraHD) 3840 x 2160p
- (2K) 2048 x 1080p
- (HD) 1920 x 1080p
- (HD) 1920 x 1080i
- (HD) 1280 x 720p
- (SD) 720 x 576p
- (SD) 720 x 576i
- (SD) 720 x 480p
- (SD) 720 x 480i

### Video Input Digital

---

- 1x HDMI Type A connector, HDMI v2.0
- YCbCr 4:2:2/4:4:4/4:2:0
- RGB 4:4:4, SMPTE or Full level
- 8, 10, or 12-bit (HFR 4K/UltraHD 4:4:4 limited to 8 bit)
- HDR Infocodec as defined in CTA-861.3 and HDMI v2.0a
- (4K) 4096 x 2160p 23.98, 24, 25, 29.97, 30, 50, 59.94, 60
- (UltraHD) 3840 x 2160p 23.98, 24, 25, 29.97, 30, 50, 59.94, 60
- (2K) 2048 x 1080p 23.98, 24, 25, 29.97, 30, 50, 59.94, 60
- (HD) 1920 x 1080p 23.98, 24, 25, 29.97, 30, 50, 59.94, 60
- (HD) 1920 x 1080i 50, 59.94, 60
- (HD) 1280 x 720p 50, 59.94, 60
- (SD) 720 x 576p 50
- (SD) 720 x 576i 50
- (SD) 720 x 480p 59.94
- (SD) 720 x 480i 59.94

### HDCP Decryption

---

Not supported. By definition, SDI outputs are unencrypted.

### Video Output Digital

---

- 4x 3G-SDI BNC, SMPTE-259/292/424
- YCbCr 4:2:2/4:4:4
- RGB 4:4:4, SMPTE or Full level
- 10-bit
- Two Sample Interleave (2SI) or Square Division (Quadrant) source mapping
- 4x 3 Gb SDI (Level A or B-Dual Link)
  - (4K) 4096 x 2160p 23.98, 24, 25, 29.97, 30, 50, 59.94, 60
  - (4K) 4096 x 2160PsF\* 23.98, 24, 25, 29.97, 30
  - (UltraHD) 3840 x 2160p 23.98, 24, 25, 29.97, 30, 50, 59.94, 60
  - (Ultra HD) 3840 x 2160PsF\* 23.98, 24, 25, 29.97, 30
- 4x 1.5 Gb SDI

- (4K) 4096 x 2160p 23.98, 24, 25, 29.97, 30
- (4K) 4096 x 2160PsF 23.98, 24, 25, 29.97, 30
- (UltraHD) 3840 x 2160p 23.98, 24, 25, 29.97, 30
- (UltraHD) 3840 x 2160PsF 23.98, 24, 25, 29.97, 30
- 2x 3 Gb SDI (Level B-Dual Stream)
  - (4K) 4096 x 2160p 23.98, 24, 25, 29.97, 30
  - (4K) 4096 x 2160PsF 23.98, 24, 25, 29.97, 30
  - (UltraHD) 3840 x 2160p 23.98, 24, 25, 29.97, 30
  - (UltraHD) 3840 x 2160PsF 23.98, 24, 25, 29.97, 30
- 1x 3 Gb SDI (Level A or B-Dual Link)
  - (2K) 2048 x 1080p 23.98, 24, 25, 29.97, 30, 50, 59.94, 60
  - (2K) 2048 x 1080PsF 23.98, 24, 25, 29.97, 30
  - (HD) 1920 x 1080p 23.98, 24, 25, 29.97, 30, 50, 59.94, 60
  - (HD) 1920 x 1080PsF 23.98, 24, 25, 29.97, 30
  - (HD) 1920 x 1080i 50, 59.94, 60
  - (HD) 1280 x 720p\*\* 50, 59.94, 60
- 1x 1.5 Gb SDI
  - (2K) 2048 x 1080p 23.98, 24, 25, 29.97, 30
  - (2K) 2048 x 1080PsF 23.98, 24, 25, 29.97, 30
  - (HD) 1920 x 1080p 23.98, 24, 25, 29.97, 30
  - (HD) 1920 x 1080PsF 23.98, 24, 25, 29.97, 30
  - (HD) 1920 x 1080i 50, 59.94, 60
  - (HD) 1280 x 720p 50, 59.94, 60
- 1x 270 Mb SDI
  - (SD) 625i 50
  - (SD) 525i 59.94

\*PsF is Level B-Dual Link

\*\*1280 x 720p is Level A Only

#### Audio Input Digital

---

- HDMI embedded audio, 24-bit, 8-Channel

#### Audio Output Digital

---

- SDI embedded audio, 24-bit, 8-Channel

#### Audio I/O

---

- 8-Channel embedded SDI audio output
- 8-Channel HDMI audio input

#### User Controls

---

- openGear DashBoard network control software via Windows, macOS or Linux

#### Size

---

- openGear standard form factor, front slot and rear card. Two slots required for each card

#### Weight

---

- 0.5 lb (0.3 kg)

#### Power

---

- openGear frame compatible, 10.0 watts max per card

## Environment

---

- Safe Operating Temperature: 0 to 40 C (32 to 104 F)
- Safe Storage Temperature (Power OFF): -40 to 60 C (-40 to 140 F)
- Operating Relative Humidity: 10-90% noncondensing
- Operating Altitude: <3,000 meters (<10,000 feet)

# Appendix B – Safety and Compliance

---

## Federal Communications Commission (FCC) Compliance Notices

---

### Class A Interference Statement

---

This equipment has been tested and found to comply with the limits for a Class A digital device, pursuant to Part 15, Subpart B of the FCC Rules. These limits are designed to provide reasonable protection against harmful interference in a residential installation. This equipment generates, uses, and can radiate radio frequency energy and, if not installed and used in accordance with the instructions, may cause harmful interference to radio communications. However, there is no guarantee that interference will not occur in a particular installation. If this equipment does cause harmful interference to radio or television reception, which can be determined by turning the equipment off and on, the user is encouraged to try to correct the interference by one or more of the following measures:

- Reorient or relocate the receiving antenna.
- Increase the separation between the equipment and receiver.
- Connect the equipment into an outlet on a circuit different from that to which the receiver is connected.
- Consult the dealer or an experienced radio/TV technician for help.

### FCC Caution

---

This device complies with Part 15 of the FCC Rules. Operation is subject to the following two conditions: (1) This device may not cause harmful interference, and (2) this device must accept any interference received, including interference that may cause undesired operation.

## Canadian ICES Statement

---

### Canadian Department of Communications Radio Interference Regulations

This digital apparatus does not exceed the Class A limits for radio-noise emissions from a digital apparatus as set out in the Radio Interference Regulations of the Canadian Department of Communications. This Class A digital apparatus complies with Canadian ICES-003.

### Règlement sur le brouillage radioélectrique du ministère des Communications

Cet appareil numérique respecte les limites de bruits radioélectriques visant les appareils numériques de classe A prescrites dans le Règlement sur le brouillage radioélectrique du ministère des Communications du Canada. Cet appareil numérique de la Classe A est conforme à la norme NMB-003 du Canada.

## European Union and European Free Trade Association (EFTA) Regulatory Compliance

---

This equipment may be operated in the countries that comprise the member countries of the European Union and the European Free Trade Association. These countries, listed in the following paragraph, are referred to as The European Community throughout this document:

AUSTRIA, BELGIUM, BULGARIA, CYPRUS, CZECH REPUBLIC, DENMARK, ESTONIA, FINLAND, FRANCE, GERMANY, GREECE, HUNGARY, IRELAND, ITALY, LATVIA, LITHUANIA, LUXEMBOURG, MALTA, NETHERLANDS, POLAND, PORTUGAL, ROMANIA, SLOVAKIA, SLOVENIA, SPAIN, SWEDEN, UNITED KINGDOM, ICELAND, LICHTENSTEIN, NORWAY, SWITZERLAND

## Declaration of Conformity

Marking by this symbol indicates compliance with the Essential Requirements of the EMC Directive of the European Union 2014/30/EU.



This equipment meets the following conformance standards:

### Safety

EN 60065: 2014 (T-Mark License),

IEC 60065: 2014 (CB Scheme Report/Certificate)

Additional licenses issued for specific countries available on request.

### Emissions

EN 55032: 2012 + AC: 2013, CISPR 32: 2015, EN 61000-3-2: 2014, EN 61000-3-3: 2013

### Immunity

EN 55103-2: 2009, EN 61000-4-2:2009, EN 61000-4-3: 2006 + A1:2008 + A2:2010,

EN 61000-4-4: 2004 + A1:2010, EN 61000-4-5:2006, EN 61000-4-6:2009,

EN 61000-4-11:2004

Environments: E2, E3 and E4

The product is also licensed for additional country specific standards as required for the International Marketplace



**Warning!** This is a Class A product. In a domestic environment, this product may cause radio interference, in which case, the user may be required to take appropriate measures.

**Achtung!** Dieses ist ein Gerät der Funkstörgrenzwertklasse A. In Wohnbereichen können bei Betrieb dieses Gerätes Rundfunkstörungen auftreten, in welchen Fällen der Benutzer für entsprechende Gegenmaßnahmen verantwortlich ist.

**Attention!** Ceci est un produit de Classe A. Dans un environnement domestique, ce produit risque de créer des interférences radioélectriques, il appartiendra alors à l'utilisateur de prendre les mesures spécifiques appropriées..

## Recycling Notice



This symbol on the product or its packaging indicates that this product must not be disposed of with your other household waste. Instead, it is your responsibility to dispose of your waste equipment by handing it over to a designated collection point for the recycling of waste electrical and electronic equipment. The separate collection and recycling of your waste equipment at the time of disposal will help conserve natural resources and ensure that it is recycled in a manner that protects human health and the environment. For more information about where you can drop off your waste for recycling, please contact your local authority, or where you purchased your product.

## Korea KCC Compliance Statement

<p>A급 기기 (업무용 방송통신기자재)</p>	<p>이 기기는 업무용(A급) 전자파적합기기로서 판매자 또는 사용자는 이 점을 주의하시기 바라며, 가정외의 지역에서 사용하는 것을 목적으로 합니다.</p>
<p>Class A (Broadcasting Communication Equipment for Office Use)</p>	<p>As an electromagnetic wave equipment for office use (Class A), this equipment is intended to use in other than home area. Sellers or users need to take note of this.</p>

## Taiwan Compliance Statement

警告使用者：  
這是甲類的資訊產品，在居住的環境中使用時，可能會造成射頻干擾，在這種情況下，使用者會被要求採取某些適當的對策。

This is a Class A product based on the standard of the Bureau of Standards, Metrology and Inspection (BSMI) CNS 13438, Class A. In a domestic environment this product may cause radio interference in which case the user may be required to take adequate measures.

## Japanese Compliance Statement

この装置は、クラスA情報技術装置です。この装置を家庭環境で使用すると電波妨害を引き起こすことがあります。この場合には使用者が適切な対策を講ずるよう要求されることがあります。 VCCI-A

This is a Class A product based on the standard of the VCCI Council (VCCI 32: 2016). If this equipment is used in a domestic environment, radio interference may occur, in which case, the user may be required to take corrective actions.

## Translated Warning and Caution Messages

The following caution statements, warning conventions, and warning messages apply to this product and manual.



Warning Symbol



Hazard Symbol



Caution Symbol

## Before Operation Please Read These Instructions



**Warning!** Read and follow all warning notices and instructions marked on the product or included in the documentation.

**Avertissement!** Lisez et conformez-vous à tous les avis et instructions d'avertissement indiqués sur le produit ou dans la documentation.

**Warnung!** Lesen und befolgen Sie die Warnhinweise und Anweisungen, die auf dem Produkt angebracht oder in der Dokumentation enthalten sind.

**¡Advertencia!** Lea y siga todas las instrucciones y advertencias marcadas en el producto o incluidas en la documentación.

**Aviso!** Leia e siga todos os avisos e instruções assinalados no produto ou incluídos na documentação.

**Avviso!** Leggere e seguire tutti gli avvisi e le istruzioni presenti sul prodotto o inclusi nella documentazione.





**Warning!** Do not use this device near water and clean only with a dry cloth.

**Avertissement!** N'utilisez pas cet appareil près de l'eau et nettoyez-le seulement avec un tissu sec.

**Warnung!** Das Gerät nicht in der Nähe von Wasser verwenden und nur mit einem trockenen Tuch säubern.

**¡Advertencia!** No utilice este dispositivo cerca del agua y límpielo solamente con un paño seco.

**Aviso!** Não utilize este dispositivo perto da água e limpe-o somente com um pano seco.

**Avviso!** Non utilizzare questo dispositivo vicino all'acqua e pulirlo soltanto con un panno asciutto.



**Warning!** Do not block any ventilation openings. Install in accordance with the manufacturer's instructions.

**Avertissement!** Ne bloquez aucune ouverture de ventilation. Suivez les instructions du fabricant lors de l'installation.

**Warnung!** Die Lüftungsöffnungen dürfen nicht blockiert werden. Nur gemäß den Anweisungen des Herstellers installieren.

**¡Advertencia!** No bloquee ninguna de las aberturas de la ventilación. Instale de acuerdo con las instrucciones del fabricante.

**Aviso!** Não obstrua nenhuma das aberturas de ventilação. Instale de acordo com as instruções do fabricante.

**Avviso!** Non ostruire le aperture di ventilazione. Installare in conformità con le istruzioni del fornitore.



**Warning!** Do not install near any heat sources such as radiators, heat registers, stoves, or other apparatus (including amplifiers) that produce heat.

**Avertissement!** N'installez pas l'appareil près d'une source de chaleur telle que des radiateurs, des bouches d'air de chauffage, des fourneaux ou d'autres appareils (amplificateurs compris) qui produisent de la chaleur.

**Warnung!** Nicht in der Nähe von Wärmequellen wie Heizkörpern, Heizregistern, Öfen oder anderen Wärme erzeugenden Geräten (einschließlich Verstärkern) aufstellen.

**¡Advertencia!** No instale cerca de fuentes de calor tales como radiadores, registros de calor, estufas u otros aparatos (incluidos amplificadores) que generan calor.

**Aviso!** Não instale perto de nenhuma fonte de calor tal como radiadores, saídas de calor, fogões ou outros aparelhos (incluindo amplificadores) que produzam calor.

**Avviso!** Non installare vicino a fonti di calore come termosifoni, diffusori di aria calda, stufe o altri apparecchi (amplificatori compresi) che emettono calore



**Warning!** Do not defeat the safety purpose of the polarized or grounding-type plug. A polarized plug has two blades with one wider than the other. A grounding type plug has two blades and a third grounding prong. The wide blade or the third prong are provided for your safety. If the provided plug does not fit into your outlet, consult an electrician for replacement of the obsolete outlet.

**Avertissement!** La sécurité de la prise polarisée ou de la prise de type mise à la terre ne doit en aucun cas être empêchée de fonctionner. Une prise polarisée a deux broches, l'une étant plus large que l'autre. Une prise de type mise à la terre a deux broches et une troisième broche pour la mise à la terre. La broche large ou la troisième broche sont fournies pour votre sécurité. Si la prise fournie ne s'insère pas dans votre prise femelle, consultez un électricien pour le remplacement de la prise femelle obsolète.

**Warnung!** Der Sicherheitszweck des gepolten bzw. Schukosteckers ist zu berücksichtigen. Ein gepolter Stecker verfügt über zwei Pole, von denen einer breiter als der andere ist. Ein Schukostecker verfügt neben den zwei Polen noch über einen dritten Pol zur Erdung. Der breite Pol bzw. der Erdungspol dienen der Sicherheit. Wenn der zur Verfügung gestellte Stecker nicht in Ihren Anschluss passt, konsultieren Sie einen Elektriker, um den veralteten Anschluss zu ersetzen.

**¡Advertencia!** No eche por tierra la finalidad del tipo de enchufe polarizado con conexión a tierra. Un enchufe polarizado tiene dos espigas, una más ancha que la otra. Un enchufe con conexión a tierra tiene dos espigas iguales y una tercera espiga que sirve para la conexión a tierra. La espiga ancha, o la tercera espiga, sirven para su seguridad. Si el enchufe suministrado no encaja en el tomacorriente, consulte con un electricista para reemplazar el tomacorriente obsoleto.

**Aviso!** Não anule a finalidade da segurança da ficha polarizada ou do tipo ligação terra. Uma ficha polarizada tem duas lâminas sendo uma mais larga do que a outra. Uma ficha do tipo de ligação à terra tem duas lâminas e um terceiro terminal de ligação à terra. A lâmina larga ou o terceiro terminal são fornecidos para sua segurança. Se a ficha fornecida não couber na sua tomada, consulte um electricista para a substituição da tomada obsoleta.

**Avviso!** Non compromettere la sicurezza della spina polarizzata o con messa a terra. Una spina polarizzata ha due spinotti, di cui uno più largo. Una spina con messa a terra ha due spinotti e un terzo polo per la messa a terra. Lo spinotto largo o il terzo polo sono forniti per motivi di sicurezza. Se la spina fornita non si inserisce nella presa di corrente, contattare un elettricista per la sostituzione della presa obsoleta.



**Warning!** Since the Mains plug is used as the disconnection for the device, it must remain readily accessible and operable.

**Avertissement!** Puisque la prise principale est utilisée pour débrancher l'appareil, elle doit rester aisément accessible et fonctionnelle.

**Warnung!** Da der Netzstecker als Trennvorrichtung dient, muss er stets zugänglich und funktionsfähig sein.

**¡Advertencia!** Puesto que el enchufe de la red eléctrica se utiliza como dispositivo de desconexión, debe seguir siendo fácilmente accesible y operable.

**Aviso!** Dado que a ficha principal é utilizada como a desconexão para o dispositivo, esta deve manter-se prontamente acessível e funcional.

**Avviso!** Poiché il cavo di alimentazione viene usato come dispositivo di sconnessione, deve rimanere prontamente accessibile e operabile.



**Warning!** Protect the power cord from being walked on or pinched particularly at plugs, convenience receptacles, and the point where they exit from the device.

**Avertissement!** Protégez le cordon d'alimentation pour que l'on ne marche pas dessus ou qu'on le pince, en particulier au niveau des prises mâles, des réceptacles de convenance, et à l'endroit où il sort de l'appareil.

**Warnung!** Vermeiden Sie, dass auf das Netzkabel getreten oder das Kabel geknickt wird, insbesondere an den Steckern, den Steckdosen und am Kabelausgang am Gerät.

**¡Advertencia!** Proteja el cable de energía para que no se le pise ni apriete, en especial cerca del enchufe, los receptáculos de conveniencia y el punto del que salen del equipo.

**Aviso!** Proteja o cabo de alimentação de ser pisado ou de ser comprimido particularmente nas fichas, em tomadas de parede de conveniência e no ponto de onde sai do dispositivo.

**Avviso!** Proteggere il cavo di alimentazione in modo che nessuno ci cammini sopra e che non venga schiacciato soprattutto in corrispondenza delle spine e del punto in cui esce dal dispositivo.



**Warning!** Unplug this device during lightning storms or when unused for long periods of time.

**Avertissement!** Débranchez cet appareil pendant les orages avec éclairsou s'il est inutilisé pendant de longues périodes.

**Warnung!** Das Gerät ist bei Gewitterstürmen oder wenn es über lange Zeiträume ungenutzt bleibt vom Netz zu trennen.

**¡Advertencia!** Desenchufe este dispositivo durante tormentas eléctricas o cuando no se lo utilice por largos periodos del tiempo.

**Aviso!** Desconecte este dispositivo da tomada durante trovoadas ou quando não é utilizado durante longos períodos de tempo.

**Avviso!** Utilizzare soltanto i collegamenti e gli accessori specificati e/o venduti dal produttore, quali il treppiedi e l'esoscheletro.



**Warning!** Refer all servicing to qualified service personnel. Servicing is required when the device has been damaged in any way, such as power-supply cord or plug is damaged, liquid has been spilled or objects have fallen into the device, the device has been exposed to rain or moisture, does not operate normally, or has been dropped.

**Avertissement!** Référez-vous au personnel de service qualifié pour tout entretien. L'entretien est exigé quand l'appareil a été endommagé de quelque manière que ce soit, par exemple lorsque le cordon d'alimentation ou la prise sont endommagés, que du liquide a été versé ou des objets sont tombés dans l'appareil, que l'appareil a été exposé à la pluie ou à l'humidité, ne fonctionne pas normalement ou est tombé.

**Warnung!** Das Gerät sollte nur von qualifizierten Fachkräften gewartet werden. Eine Wartung ist fällig, wenn das Gerät in irgendeiner Weise beschädigt wurde, wie bei beschädigtem Netzkabel oder Netzstecker, falls Flüssigkeiten oder Objekte in das Gerät gelangen, das Gerät Regen oder Feuchtigkeit ausgesetzt wurde, nicht ordnungsgemäß funktioniert oder fallen gelassen wurde.

**¡Advertencia!** Consulte al personal calificado por cuestiones de reparación. El servicio de reparación se requiere cuando el dispositivo ha recibido cualquier tipo de daño, por ejemplo cable o espigas dañadas, se ha derramado líquido o se han caído objetos dentro del dispositivo, el dispositivo ha sido expuesto a la lluvia o humedad, o no funciona de modo normal, o se ha caído.

**Aviso!** Remeta todos os serviços de manutenção para o pessoal de assistência qualificado. A prestação de serviços de manutenção é exigida quando o dispositivo foi danificado mediante qualquer forma, como um cabo de alimentação ou ficha que se encontra danificado/a, quando foi derramado líquido ou caíram objectos sobre o dispositivo, quando o dispositivo foi exposto à chuva ou à humidade, quando não funciona normalmente ou quando foi deixado cair.

**Avviso!** Fare riferimento al personale qualificato per tutti gli interventi di assistenza. L'assistenza è necessaria quando il dispositivo è stato danneggiato in qualche modo, ad esempio se il cavo di alimentazione o la spina sono danneggiati, è stato rovesciato del liquido è stato rovesciato o qualche oggetto è caduto nel dispositivo, il dispositivo è stato esposto a pioggia o umidità, non funziona correttamente o è caduto



**Warning!** Do not open the chassis. There are no user-serviceable parts inside. Opening the chassis will void the warranty unless performed by an AJA service center or licensed facility.

**Avertissement!** Ne pas ouvrir le châssis. Aucun élément à l'intérieur du châssis ne peut être réparé par l'utilisateur. La garantie sera annulée si le châssis est ouvert par toute autre personne qu'un technicien d'un centre de service ou d'un établissement agréé AJA.

**Warnung!** Öffnen Sie das Gehäuse nicht. Keine der Geräteteile können vom Benutzer gewartet werden. Durch das Öffnen des Gehäuses wird die Garantie hinfällig, es sei denn, solche Wartungsarbeiten werden in einem AJA-Service-Center oder einem lizenzierten Betrieb vorgenommen.

**¡Advertencia!** No abra el chasis. El interior no contiene piezas reparables por el usuario. El abrir el chasis anulará la garantía a menos que se lo haga en un centro de servicio AJA o en un local autorizado.

**Advertência!** Não abra o chassi. Não há internamente nenhuma peça que permita manutenção pelo usuário. Abrir o chassi anula a garantia, a menos que a abertura seja realizada por uma central de serviços da AJA ou por um local autorizado.

**Avvertenza!** Non aprire lo chassis. All'interno non ci sono parti riparabili dall'utente. L'apertura dello chassis invaliderà la garanzia se non viene effettuata da un centro ufficiale o autorizzato AJA.



**Warning!** Disconnect the external AC power supply line cord(s) from the mains power before moving the unit.

**Avertissement!** Retirez le ou les cordons d'alimentation en CA de la source d'alimentation principale lorsque vous déplacez l'appareil.

**Warnung!** Trennen Sie die Wechselstrom-Versorgungskabel vom Netzstrom, bevor Sie das Gerät verschieben.

**¡Advertencia!** Cuando mueva la unidad desenchufe de la red eléctrica el/los cable(s) de la fuente de alimentación CA tipo brick.

**Advertência!** Remova os cabos CA de alimentação brick da rede elétrica ao mover a unidade.

**Avvertenza!** Scollegare il cavo dell'alimentatore quando si sposta l'unità.



**Warning!** Only use attachments and accessories specified and/or sold by the manufacturer.

**Avertissement!** Utilisez seulement les attaches et accessoires spécifiés et/ou vendus par le fabricant.

**Warnung!** Verwenden Sie nur Zusatzgeräte und Zubehör angegeben und / oder verkauft wurde durch den Hersteller.

**¡Advertencia!** Utilice solamente los accesorios y conexiones especificados y/o vendidos por el fabricante.

**Aviso!** Utilize apenas equipamentos/acessórios especificados e/ou vendidos pelo fabricante.

**Avviso!** Utilizzare soltanto i collegamenti e gli accessori specificati e/o venduti dal produttore.



**Hazard!** High Voltage. This situation or condition can cause injury due to electric shock.

**Avertissement!** Tension élevée. Cette situation ou condition peut causer des blessures dues à un choc électrique.

**Warnung!** Hochspannung. Diese Situation oder Bedingung kann zu Verletzungen durch Stromschlag führen.

**¡Advertencia!** Alto voltaje . Esta situación o condición puede causar lesiones debidas a una descarga eléctrica.

**Aviso!** Alta Tensão . Esta situação ou condição pode causar danos devido a choques elétricos.

**Avviso!** Alta tensione. Questa situazione o condizione può causare lesioni a causa di scosse elettriche.



**Caution!** To meet safety regulations for leakage current, connect the dual power supplies to separate branch circuits.

**¡Advertencia!** Para cumplir con las normas de seguridad para la corriente de fuga, conecte las dos fuentes de alimentación para circuitos derivados diferentes.

**Attention!** Pour répondre aux mesures de sécurité concernant le courant de fuite, raccorder les sources d'alimentation doubles à des circuits de dérivation distincts.

**Warnung!** Zur Erfüllung der Sicherheitsbestimmungen bezüglich Reststrom schließen Sie bitte die zwei Netzteile an unterschiedlichen Abzweigleitungen an.

**Cuidado!** Para atender aos regulamentos de segurança para correntes de fuga, conecte as fontes duplas a circuitos elétricos separados.

**Attenzione!** Per soddisfare le norme di sicurezza sulla corrente di perdita, collegare i doppi alimentatori a circuiti derivati separati.



**Warning!** Ensure Mains Power is disconnected before installing the OG-HA5-4K modules into the frame, or installing and removing options. If a Mains switch is not provided, the power cord(s) of this equipment provide the means of disconnection. The socket outlet must be installed near the equipment and must be easily accessible.

**Avertissement !** Avant d'installer des modules OG-HA5-4K dans la structure, ainsi qu'avant d'installer ou d'enlever des options, assurez-vous d'avoir déconnecté l'alimentation électrique. S'il n'y a pas d'interrupteur électrique, il faut débrancher les câbles électriques de l'équipement. La prise électrique doit être située à proximité de l'équipement et doit être aisément accessible.

**Achtung!** Sicherstellen, dass die Netzleitung entkoppelt ist, bevor die OG-HA5-4K Module in das Gestell eingebaut oder Wahlteile eingebaut bzw. ausgebaut werden. Wenn kein Netzschalter vorgesehen ist, dient das bzw. dienen die Netzkabel dieser Vorrichtung als Entkopplungsmittel. Die Steckdose muss in der Nähe der Vorrichtung installiert und leicht zugänglich sein.

**Avvertenza.** Accertarsi che l'alimentazione di rete sia scollegata prima di installare i moduli OG-HA5-4K nel frame o di installare e rimuovere componenti opzionali. Se non è presente un interruttore di accensione/spengimento, occorre scollegare il cavo (o i cavi) di alimentazione di questo apparecchio dalla presa di corrente. La presa di corrente deve essere situata presso l'apparecchio e facilmente accessibile.

**Aviso!** Certifique-se que a fonte principal de energia elétrica está desconectada antes de instalar os módulos OG-HA5-4K no bastidor ou antes de instalar e remover opções. Se o interruptor principal não existir, o cabo elétrico deste equipamento proporciona o meio de desconexão. A tomada elétrica deverá ser instalada perto do equipamento e deverá ser de fácil acesso.

**¡Advertencia!** Asegúrese que la red de alimentación está desconectada antes de instalar los módulos OG-HA5-4K en el marco, o la instalación y extracción de opciones. Si no se proporciona un conmutador de red, el cable de alimentación de este equipo proporciona los medios de desconexión. El zócalo tomacorriente debe estar instalado cerca del equipo y debe ser fácilmente accesible.



**Warning!** Dual Power Cord Notice—please read this. To reduce the risk of electrical shock, disconnect both power cords before servicing equipment.

**Avertissement !** Avis concernant la double alimentation électrique—à lire soigneusement. Pour éviter tout risque d'électrocution, débranchez les deux câbles électriques avant d'intervenir sur l'équipement.

**Achtung!** Hinweis auf Doppel-Netzkabel-bitte lesen. Um das Risiko eines Elektroschocks zu verringern, müssen beide Netzkabel ausgestöpselt werden, bevor die Vorrichtung gewartet wird.

**Avvertenza.** Avviso concernente il cavo di alimentazione doppio - leggere attentamente. Per ridurre il rischio di elettrocuzione, scollegare entrambi i cavi di alimentazione prima di eseguire la manutenzione o riparazioni di questo apparecchio.

**Aviso!** Aviso de Cabo Elétrico Duplo - por favor, leia isto. Para reduzir o risco de choque elétrico, desconecte ambos os cabos elétricos antes de fazer manutenção ao equipamento.

**¡Advertencia!** Aviso del doble cable de alimentación - leer esto por favor. Para reducir el riesgo de descarga eléctrica, desconecte ambos cables de alimentación antes de dar servicio al equipo.



**Caution!** The OG-X-FR front fan door is heavy. Remove with Caution.

**Attention!** La porte du ventilateur avant OG-X-FR est lourde. Retirer avec précaution.

**Achtung!** Die OG-X-FR Frontlüfter Tür ist schwer. Bitte vorsichtig entfernen.

**¡Precaución!** La puerta del ventilador frontal OG-X-FR es pesado. Extraer con precaución.

**Atenção!** A porta do ventilador frontal OG-X-FR é pesado. Remova com cuidado.

**Attenzione!** La porta ventola anteriore OG-X-FR è pesante. Rimuovere con cautela.

# Warranty and Liability Information

---

AJA VIDEO SYSTEMS, INC.

## Limited Warranty on Hardware

---

AJA Video Systems, Inc. (AJA Video) warrants that the hardware product, not including storage modules or software components, will be free from defects in materials and workmanship for a period of five (5) years from the date of purchase. AJA Video warrants that the storage modules provided as part of the hardware product will be free from defects in materials and workmanship for a period of one year from the date of purchase. AJA Video provides a separate software warranty as part of the license agreement applicable to software components.

If a hardware product or storage module (hereafter, a “product”) proves to be defective during the applicable warranty period, AJA Video, at its option, will either repair the defective product without charge for parts and labor, or will provide a replacement in exchange for the defective product.

To obtain service under this warranty, the Customer must notify AJA Video of the defect before expiration of the warranty period and make suitable arrangements for the performance of service by contacting AJA Video support through the channels set forth on the support contacts web page at <http://www.aja.com/support>. Except as stated, the Customer shall bear all shipping, packing, insurance and other costs, excluding parts and labor, to effectuate repair. Customer shall pack and ship the defective product to a service center designated by AJA Video, with shipping charges prepaid. AJA Video shall pay to return the product to Customer but only if to a location within the country in which the AJA Video service center is located.

This warranty shall not apply to any defect, failure or damage caused by negligent, inadequate or improper use, handling or maintenance. Without limiting the foregoing, AJA Video shall not be obligated to furnish service under this warranty or repair any damage or malfunction a) resulting from attempts by personnel other than AJA Video representatives to install, repair or service the product, b) resulting from improper use or connection to incompatible equipment, c) caused by the use of non-AJA Video parts or supplies, d) if the product has been modified or integrated with other products when the effect of such a modification or integration increases the time or difficulty of servicing the product, or e) resulting from being dropped or otherwise subjected to undue force, exposure to moisture or other corrosive or conductive substances, exposure to strong magnetic fields, use with improperly regulated power supplies, exposure to electric shock, use in temperatures outside the specified operating range, or otherwise failing to treat the product in accordance with the standard of care appropriate to sensitive and delicate electronic equipment.

EXCEPT AS STATED ABOVE, AJA VIDEO AND ITS VENDORS DISCLAIM IN THEIR ENTIRETY ALL OTHER WARRANTIES, EXPRESS OR IMPLIED, INCLUDING WITHOUT LIMITATION ALL WARRANTIES OF MERCHANTABILITY OR FITNESS FOR A PARTICULAR PURPOSE. AJA VIDEO'S RESPONSIBILITY TO REPAIR OR REPLACE TIMELY REPORTED DEFECTIVE PRODUCTS IS THE WHOLE AND EXCLUSIVE REMEDY CUSTOMER IS PROVIDED WITH RESPECT TO HARDWARE PRODUCTS AND THEIR STORAGE MODULES. SOME JURISDICTIONS DO NOT ALLOW THE EXCLUSION OF IMPLIED WARRANTIES OR LIMITATIONS ON APPLICABLE STATUTORY RIGHTS OF A CONSUMER, SO SOME OR ALL OF THE TERMS OF THIS PARAGRAPH MAY NOT APPLY TO YOU.

THE PRODUCT IS NOT INTENDED, STATED, OR WARRANTED TO OPERATE UNINTERRUPTED OR ERROR-FREE. YOU UNDERSTAND AND ACKNOWLEDGE THAT THE PRODUCT IS NOT INTENDED TO BE USED AS THE SOLE OR PRIMARY DATA SOURCE OR TARGET FOR CRITICAL DATA, AND THAT IT IS YOUR RESPONSIBILITY TO IMPLEMENT REDUNDANT CAPTURE AND BACKUP SYSTEMS AS APPROPRIATE.

## Limitation of Liability

---

Under no circumstances shall AJA video BE LIABLE IN ANY WAY FOR ANY LOST, CORRUPTED OR DESTROYED DATA, FOOTAGE OR WORK, OR FOR ANY OTHER INDIRECT, SPECIAL, INCIDENTAL OR CONSEQUENTIAL DAMAGES OR LOST PROFITS, OR FOR ANY THIRD PARTY CLAIM, IN CONNECTION WITH THE PRODUCT, WHETHER RESULTING FROM DEFECTS IN THE PRODUCT, SOFTWARE OR HARDWARE FAILURE, OR ANY OTHER CAUSE WHATSOEVER, EVEN IF AJA VIDEO HAS BEEN ADVISED OF THE POSSIBILITY OF SUCH DAMAGES. AJA VIDEO'S LIABILITY IN CONNECTION WITH THE PRODUCT SHALL UNDER NO CIRCUMSTANCES EXCEED THE PURCHASE PRICE PAID FOR THE PRODUCT. The foregoing limitations apply even if any remedy set forth in this LIMITED WARRANTY fails of its essential purpose. SOME JURISDICTIONS DO NOT ALLOW THE LIMITATION OF LIABILITY FOR PERSONAL INJURY, OR OF INCIDENTAL OR CONSEQUENTIAL DAMAGES, SO SOME OR ALL OF THE TERMS OF THIS PARAGRAPH MAY NOT APPLY TO YOU.

## Governing Law and Language; Your Rights.

---

This limited warranty is the only warranty provided by AJA Video on the hardware product. It supersedes all prior or contemporaneous understandings regarding such subject matter. No amendment to or modification of this warranty will be binding unless in writing and signed by AJA Video. The laws of the State of California, USA will govern this warranty and any dispute arising from it. Any translation of this Agreement is intended for convenience and to meet local requirements and in the event of a dispute between the English and any non-English versions, the English version of this warranty will govern. This limited warranty gives you specific legal rights and you may have other rights that vary from jurisdiction to jurisdiction, some of which are noted above.



# Index

---

## Symbols

- 3G-SDI Mode setting
  - Output Tab Screen 21
- 4K/UHD LFR setting
  - Output Tab Screen 21

## A

- AJA Support 2
- Audio Tab Screen 22

## C

- Colorimetry
  - HDR Tab Screen 17
- Color Space 20

## D

- DA Function 4
  - Output Tab Screen 21
- DashBoard Control System 8
  - Card Tab Screen 15
  - Documentation 13
  - Downloading 13
  - HDR Tab Screen 17
  - Rebooting 25
  - Requirements 13
  - Setup Tab Screen 22
  - Status Tab Screen 16
  - Uploading New Software 23
    - Using 13
- Default Operation 4
- Diagram
  - Simplified Block 5
- Display Mastering Luminance
  - HDR Tab Screen 18

## E

- Embed into SDI setting
  - Audio Tab Screen 22
- Enable P to PsF setting
  - Output Tab Screen 21
- EOTF
  - HDR Tab Screen 18

## F

- Features 4

## G

- Genlock setting
  - Output Tab Screen 21

## H

- HDR Detected
  - HDR Tab Screen 17

## I

- Input Tab Screen 19
- Installation 9
  - Cabling 12
  - Front Card Installation 10
  - Rear Card Installation 9
- I/O Connections 6

## M

- Mapping setting
  - Output Tab Screen 21
- Maximum Content Light Level (CLL)
  - HDR Tab Screen 18
- Maximum Frame Average Light Level (FALL)
  - HDR Tab Screen 18

## O

- openGear and AJA 9
- Output Tab Screen 20
- Overview 4

## P

- Pad/Crop setting
  - Output Tab Screen 20

## R

- RGB Range setting
  - Input Tab Screen 19
  - Output Tab Screen 20

## S

- Signal Indicators
  - DashBoard Control System 7
  - LED Lights on Card 6
- SRC setting
  - Audio Tab Screen 22

## T

- Technical Support 2

## U

- User Controls 8