

HD AV MIXER VR-4HD

Owner's Manual Version 1.5 and later

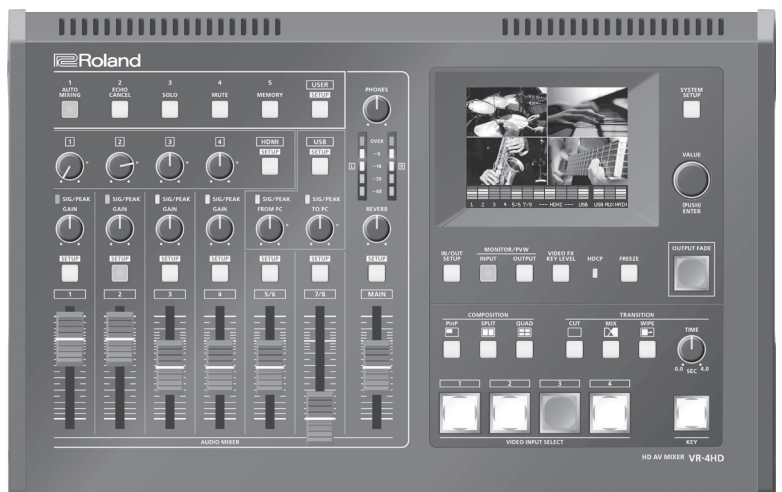

Before using the VR-4HD, ensure that its system program is at the most recent version. For information on available upgrades for the system program, see the Roland website (<https://proav.roland.com/>).

You can check the system program version by pressing the [SYSTEM SETUP] button → <SYSTEM> → <VERSION>.

Owner's Manual (this document)

Read this first. It explains the basic things you need to know in order to use the VR-4HD.

PDF Manual (download from the Web)

• Reference Manual

This manual covers all menu items of the VR-4HD. It also describes control via MIDI, RS-232, and TALLY/GPIO.

To obtain the PDF manual

1. Enter the following URL in your computer.
<https://proav.roland.com/>



2. Go to the VR-4HD product page and click the "Support."

Contents

USING THE UNIT SAFELY	3
IMPORTANT NOTES	5
Panel Descriptions	6
Top Panel/Front Panel	6
Rear Panel/Side Panel (Connecting Your Equipment)	8
Basic Operations	10
Turning the Power On and Off	10
Switching the View Mode of the Built-in Monitor and Preview Output	10
Working with Setup Screens (Menus)	11
List of Supported Video Formats	12
Input Formats	12
Output Formats	12
Video Input/Output Settings	13
Setting the Video Input/Output Format	13
Setting the System Format	13
Setting the Input Format for Channel 4	14
Setting the Output Format for Main Output	14
Assigning a Video Source to Channel 4	15
Adjusting Output Video	15
Adjusting the Input Video on Channel 4	16
Specifying the Video Output from the PVW OUT Connector/USB 3.0 Port	16
Inputting Copyright-protected (HDCP) Video	17
Video Operations	18
Switching the Video	18
Switching by Tapping the Screen	18
Switching the Video Using Buttons	18
Switching Automatically (Auto Scan)	19
Applying a Fade to the Main Output Video (Output Fade)	19
Freezing Input Video (Freeze)	20
Capturing a Still Image from Input Video	20
Video Effect Operations	21
Using Filter Effects	21
Using Compositing Effects	22
Compositing Using Picture-in-Picture (PiP)	22
Compositing Using Split (SPLIT)	23
Compositing Four Video Streams on a Single Screen (QUAD) ..	24
Compositing Using Key	24

Audio Operations	26
Adjusting the Volume Level of Input Audio	26
Adjusting Input Gain	26
Adjusting the Sound Position (Pan)	27
Adjusting the Volume Balance	27
Adjusting the Volume Level of Main Output Audio	27
Adjusting the Volume Level of USB Output Audio	27
Applying Effects to Audio	28
Applying Effects to Input Audio	28
Applying Effects to Main Output Audio	29
Hearing Only Specific Input Audio (Solo/Mute)	30
Eliminating Echo in Web Conferencing Systems (Echo Cancel)	31
Controlling Fader Operation Automatically (Auto Mixing)	32
Using the AUX Bus	33
Interlinking Audio Output to Video Switching (Audio Follow)	34
Aligning the Output Timing of Video and Audio (Lip-sync)	35
Operations Using a Computer	36
Outputting Streaming-use Video/Audio to a Computer	36
Using the Loopback Feature	36
Recording Video on a Computer	36
Other Features	37
Assigning Functions to USER Buttons	37
Saving/Recalling Settings (Memory)	38
Saving a Memory	38
Recalling a Memory	39
Preventing Unintended Operation (Panel Lock)	39
Turning Off the Power Automatically (Auto Off)	40
Returning Settings to the Factory-default State (Factory Reset)	40
Operating the VR-4HD by Remote Control	41
Outputting a Tally Signal or Control Signal	41
Calibrating the Tap Points on the Touch Panel	42
Appendices	43
Troubleshooting	43
Block Diagram	44
Main Specifications	46
Dimensions	47
Transition Effects List	48
Index	49

Before using this unit, carefully read "USING THE UNIT SAFELY" (p. 3) and "IMPORTANT NOTES" (p. 5). After reading, keep the document(s) including those sections where it will be available for immediate reference.

Checking the Included Items

The VR-4HD includes the following items. Please take a moment to confirm that all of these items have been included with the VR-4HD. If you find that any item is missing, contact the nearest authorized Roland distributor in your country.

The Unit



AC Adaptor/Power Cord



* The shape of the power cord's plug varies depending on the country.

Owner's Manual



Conventions in this manual



In order to explain the operations as clearly as possible, this manual uses the following conventions.

- Text enclosed in square brackets [] indicates the name of a button or a knob, such as the [SETUP] button, [VALUE] knob.
- Text enclosed in angle brackets < > indicates text that appears in the screen, such as <SYSTEM>.



USING THE UNIT SAFELY

INSTRUCTIONS FOR THE PREVENTION OF FIRE, ELECTRIC SHOCK, OR INJURY TO PERSONS

About ⚠ WARNING and ⚠ CAUTION Notices

 WARNING	Used for instructions intended to alert the user to the risk of death or severe injury should the unit be used improperly.
 CAUTION	Used for instructions intended to alert the user to the risk of injury or material damage should the unit be used improperly. * Material damage refers to damage or other adverse effects caused with respect to the home and all its furnishings, as well to domestic animals or pets.

About the Symbols

	The ⚠ symbol alerts the user to important instructions or warnings. The specific meaning of the symbol is determined by the design contained within the triangle. In the case of the symbol at left, it is used for general cautions, warnings, or alerts to danger.
	The ⚡ symbol alerts the user to items that must never be carried out (are forbidden). The specific thing that must not be done is indicated by the design contained within the circle. In the case of the symbol at left, it means that the unit must never be disassembled.
	The ⚡ symbol alerts the user to things that must be carried out. The specific thing that must be done is indicated by the design contained within the circle. In the case of the symbol at left, it means that the power-cord plug must be unplugged from the outlet.

ALWAYS OBSERVE THE FOLLOWING

WARNING

To completely turn off power to the unit, pull out the plug from the outlet

Even with the power switch turned off, this unit is not completely separated from its main source of power. When the power needs to be completely turned off, turn off the power switch on the unit, then pull out the plug from the outlet. For this reason, the outlet into which you choose to connect the power cord's plug should be one that is within easy reach and readily accessible.



Concerning the Auto Off function

On this unit, the power is automatically turned off after a predetermined amount of time has passed since an operation was performed (Auto Off function). If you do not want the power to be turned off automatically, disengage the Auto Off function (p. 40).



Do not disassemble or modify by yourself

Do not carry out anything unless you are instructed to do so in the owner's manual. Otherwise, you risk causing malfunction.



Do not repair or replace parts by yourself

Refer all servicing to your retailer, the nearest Roland Service Center, or an authorized Roland distributor, as listed on the "Information."



Do not use or store in the following types of locations

- Subject to temperature extremes (e.g., direct sunlight in an enclosed vehicle, near a heating duct, on top of heat-generating equipment); or are
- Damp (e.g., baths, washrooms, on wet floors); or are
- Exposed to steam or smoke; or are
- Subject to salt exposure; or are
- Exposed to rain; or are
- Dusty or sandy; or are
- Subject to high levels of vibration and shakiness; or are
- Placed in a poorly ventilated location.



Do not place in an unstable location

Otherwise, you risk injury as the result of the unit toppling over or dropping down.



WARNING

Use only the supplied AC adaptor and the correct voltage

Be sure to use only the AC adaptor supplied with the unit. Also, make sure the line voltage at the installation matches the input voltage specified on the AC adaptor's body. Other AC adaptors may use a different polarity, or be designed for a different voltage, so their use could result in damage, malfunction, or electric shock.



Use only the supplied power cord

Use only the attached power cord. Also, the supplied power cord must not be used with any other device.



Do not bend the power cord or place heavy objects on it

Otherwise, fire or electric shock may result.



Avoid extended use at high volume

Use of the unit at high volume for extended periods of time may cause hearing loss. If you ever experience any hearing loss or ringing in the ears, you should immediately stop using the unit and consult a specialized physician.



Do not allow foreign objects or liquids to enter unit; never place containers with liquid on unit

Do not place containers containing liquid (e.g., flower vases) on this product. Never allow foreign objects (e.g., flammable objects, coins, wires) or liquids (e.g., water or juice) to enter this product. Doing so may cause short circuits, faulty operation, or other malfunctions.



WARNING

Turn off the unit if an abnormality or malfunction occurs

Immediately turn the unit off, remove the AC adaptor from the outlet, and request servicing by your retailer, the nearest Roland Service Center, or an authorized Roland distributor, as listed on the "Information" when:

- The AC adaptor or the power cord has been damaged; or
- If smoke or unusual odor occurs; or
- Objects have fallen into, or liquid has been spilled onto the unit; or
- The unit has been exposed to rain (or otherwise has become wet); or
- The unit does not appear to operate normally or exhibits a marked change in performance.



Be cautious to protect children from injury

Always make sure that an adult is on hand to provide supervision and guidance when using the unit in places where children are present, or when a child will be using the unit.



Do not drop or subject to strong impact

Otherwise, you risk causing damage or malfunction.



Do not share an outlet with an unreasonable number of other devices

Otherwise, you risk overheating or fire.



Do not use overseas

Before using the unit in overseas, consult with your retailer, the nearest Roland Service Center, or an authorized Roland distributor, as listed on the "Information."



USING THE UNIT SAFELY

CAUTION

When disconnecting the power cord, grasp it by the plug

To prevent conductor damage, always grasp the power cord by its plug when disconnecting it.



Periodically clean the power plug

An accumulation of dust or foreign objects between the power plug and the power outlet can lead to fire or electric shock.



At regular intervals, be sure to pull out the power plug, and using a dry cloth, wipe away any dust or foreign objects that may have accumulated.

Disconnect the power plug whenever the unit will not be used for an extended period of time

Fire may result in the unlikely event that a breakdown occurs.



Route all power cords and cables in such a way as to prevent them from getting entangled

Injury could result if someone were to trip on a cable and cause the unit to fall or topple.



Avoid climbing on top of the unit, or placing heavy objects on it

Otherwise, you risk injury as the result of the unit toppling over or dropping down.



Never connect/disconnect a power plug if your hands are wet

Otherwise, you could receive an electric shock.



Disconnect all cords/cables before moving the unit

Before moving the unit, disconnect the power plug from the outlet, and pull out all cords from external devices.



Before cleaning the unit, disconnect the power plug from the outlet

If the power plug is not removed from the outlet, you risk receiving an electric shock.



Whenever there is a threat of lightning, disconnect the power plug from the outlet

If the power plug is not removed from the outlet, you risk causing malfunction or receiving an electric shock.



Handle the ground terminal carefully

If you remove the screw from the ground terminal, be sure to replace it; don't leave it lying around where it could accidentally be swallowed by small children. When refastening the screw, make that it is firmly fastened, so it won't come loose.



Precautions concerning use of phantom power supply

Always turn the phantom power off when connecting any device other than condenser microphones that require phantom power. You risk causing damage if you mistakenly supply phantom power to dynamic microphones, audio playback devices, or other devices that don't require such power. Be sure to check the specifications of any microphone you intend to use by referring to the manual that came with it.



(This instrument's phantom power: 48 V DC, 10 mA Max)

IMPORTANT NOTES

Power Supply

- Do not connect this unit to same electrical outlet that is being used by an electrical appliance that is controlled by an inverter or a motor (such as a refrigerator, washing machine, microwave oven, or air conditioner). Depending on the way in which the electrical appliance is used, power supply noise may cause this unit to malfunction or may produce audible noise. If it is not practical to use a separate electrical outlet, connect a power supply noise filter between this unit and the electrical outlet.
- The AC adaptor will begin to generate heat after long hours of consecutive use. This is normal, and is not a cause for concern.

Placement

- Using the unit near power amplifiers (or other equipment containing large power transformers) may induce hum. To alleviate the problem, change the orientation of this unit; or move it farther away from the source of interference.
- This unit may interfere with radio and television reception. Do not use this unit in the vicinity of such receivers.
- Noise may be produced if wireless communications devices, such as cell phones, are operated in the vicinity of this unit. Such noise could occur when receiving or initiating a call, or while conversing. Should you experience such problems, you should relocate such wireless devices so they are at a greater distance from this unit, or switch them off.
- When moved from one location to another where the temperature and/or humidity is very different, water droplets (condensation) may form inside the unit. Damage or malfunction may result if you attempt to use the unit in this condition. Therefore, before using the unit, you must allow it to stand for several hours, until the condensation has completely evaporated.
- Depending on the material and temperature of the surface on which you place the unit, its rubber feet may discolor or mar the surface.
- Do not place containers or anything else containing liquid on top of this unit. Also, whenever any liquid has been spilled on the surface of this unit, be sure to promptly wipe it away using a soft, dry cloth.

Maintenance

- Never use benzene, thinners, alcohol or solvents of any kind, to avoid the possibility of discoloration and/or deformation.

Repairs and Data

- Before sending the unit away for repairs, back up the data stored in the unit by writing down the stored information or by using VR-4HD RCS dedicated software (p. 41). Although we will do our utmost to preserve the data stored in your unit when we carry out repairs, in some cases, such as when the memory section is physically damaged, restoration of the stored content may be impossible. Roland assumes no liability concerning the restoration of any stored content that has been lost.

Grounding Terminal

- Depending on the circumstances of a particular setup, you may experience a discomforting sensation, or perceive that the surface feels gritty to the touch when you touch this device, microphones connected to it, or the metal portions of other objects. This is due to an infinitesimal electrical charge, which is absolutely harmless. However, if you are concerned about this, connect the ground terminal (see figure on page 8) with an external ground. When the unit is grounded, a slight hum may occur, depending on the particulars of your installation. If you are unsure of the connection method, contact the nearest Roland Service Center, or an authorized Roland distributor, as listed on the "Information."

Unsuitable places for connection

- Water pipes (may result in shock or electrocution)
- Gas pipes (may result in fire or explosion)
- Telephone-line ground or lightning rod (may be dangerous in the event of lightning)

Additional Precautions

- Any data stored within the unit can be lost as the result of equipment failure, incorrect operation, etc. To protect yourself against the irretrievable loss of important data stored in the unit, use VR-4HD RCS dedicated software (p. 41) to make backups.
- Roland assumes no liability concerning the restoration of any stored content that has been lost.
- Use a reasonable amount of care when using the unit's buttons, sliders, or other controls; and when using its jacks and connectors. Rough handling can lead to malfunctions.
- Never strike or apply strong pressure to the display.
- When disconnecting all cables, grasp the connector itself—never pull on the cable. This way you will avoid causing shorts, or damage to the cable's internal elements.
- To avoid disturbing others nearby, try to keep the unit's volume at reasonable levels.
- This unit allows you to switch images at high speed. For some people, viewing such images can cause headache, nausea, or other discomfort. Do not use this unit to create video that might cause these types of health problems. Roland Corporation will accept no responsibility for any such health problems that may occur in yourself or in viewers.
- Do not use connection cables that contain a built-in resistor.

Intellectual Property Right

- It is forbidden by law to make an audio recording, video recording, copy or revision of a third party's copyrighted work (musical work, video work, broadcast, live performance, or other work), whether in whole or in part, and distribute, sell, lease, perform or broadcast it without the permission of the copyright owner.
- Do not use this product for purposes that could infringe on a copyright held by a third party. We assume no responsibility whatsoever with regard to any infringements of third-party copyrights arising through your use of this product.
- This product can be used to record or duplicate audio or visual material without being limited by certain technological copy-protection measures. This is due to the fact that this product is intended to be used for the purpose of producing original music or video material, and is therefore designed so that material that does not infringe copyrights belonging to others (for example, your own original works) can be recorded or duplicated freely.
- This product contains eParts integrated software platform of eSOL Co.,Ltd. eParts is a trademark of eSOL Co., Ltd. in Japan.
- Roland is an either registered trademark or trademark of Roland Corporation in the United States and/or other countries.
- Company names and product names appearing in this document are registered trademarks or trademarks of their respective owners.

Panel Descriptions

Top Panel/Front Panel

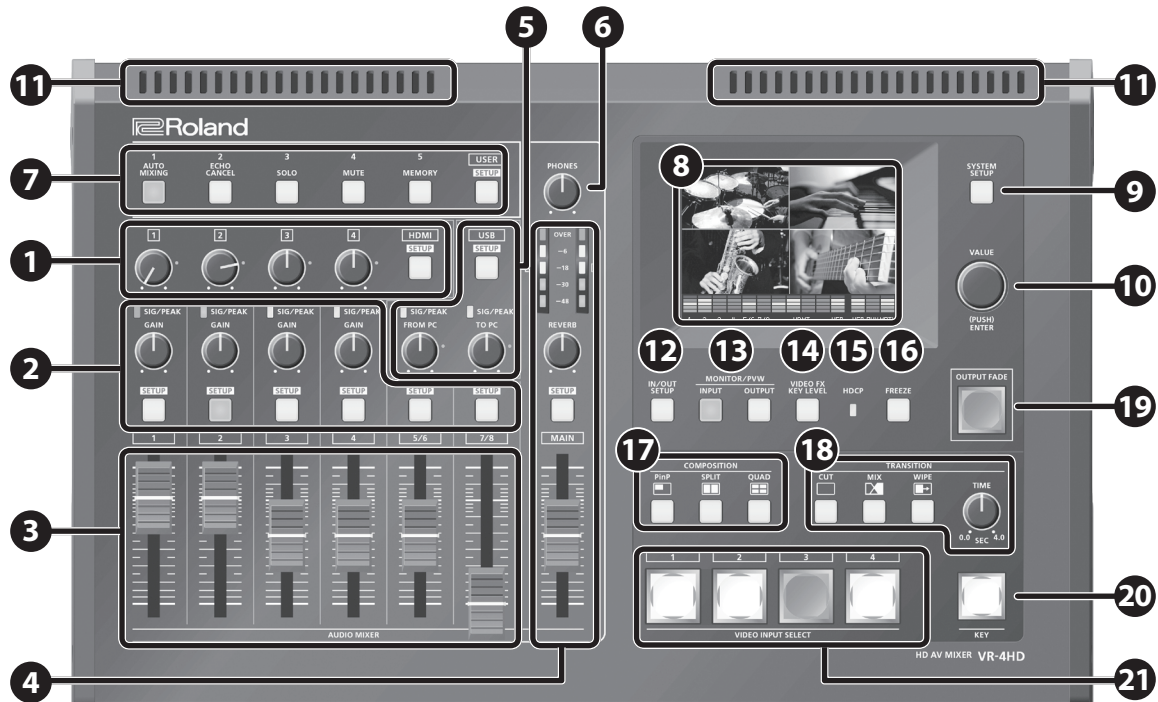

Front Panel



Audio Section

This section is for mixing audio and adjusting the input sensitivity of the audio channels.

No.	Name	Explanation	Page
1	HDMI [1]–[4] knobs	This adjusts the volume level of HDMI audio (embedded audio).	p. 27
	HDMI [SETUP] button	This displays the setup screen for HDMI audio on the built-in monitor.	p. 11
2	SIG/PEAK indicators	These display the input level of the audio channels.	p. 26
	[GAIN] knobs	These adjust the gain (input sensitivity) of the audio channels.	
	[SETUP] button	These display the setup screens for the audio channels on the built-in monitor.	p. 11
3	Channel faders	These adjust the volume levels of the audio channels.	p. 27
4	Level meter	This displays the volume level of the main output audio.	p. 29
	[REVERB] knob	This adjusts the return level from reverb of the audio.	p. 27
	[MAIN] fader	This adjusts the volume level of the main output audio.	p. 29
	MAIN [SETUP] button	This displays the setup screen for main audio output on the built-in monitor.	p. 11
	USB [SETUP] button	This displays the setup screen for USB audio (input/output) on the built-in monitor.	p. 11
5	SIG/PEAK indicator	This displays the input/output level of USB audio.	p. 27
	[FROM PC] knob	This adjusts the volume level of audio input via USB.	p. 27
	[TO PC] knob	This adjusts the volume level of audio output via USB.	p. 27
6	[PHONES] knob	This adjusts the volume of headphones connected to the PHONES jack.	—

Common Section

No.	Name	Explanation	Page
7	USER [1]–[5] buttons	You use these to switch assigned functions on and off, and to display screens for accessing functions. * By factory default, the functions shown on the operation panel are assigned to the USER buttons.	p. 37
	USER [SETUP] button	This displays the setup screen for USER buttons on the built-in monitor.	
8	Monitor (touch screen)	<ul style="list-style-type: none"> This displays the incoming video from the sources, output video, a volume level meter, and setup screens. To change the monitor's view mode, use 13 the [INPUT] or [OUTPUT] buttons. You can change the picture and select menu items by tapping the screen. * Don't touch the screen in two or more locations simultaneously; the locations will not be detected correctly.	p. 10 p. 11 p. 18
9	[SYSTEM SETUP] button	This displays the setup screen for items related to video, audio, and the unit on the built-in monitor.	p. 11
10	[VALUE] knob	Use this knob to move the cursor to setup screens and other areas, and to change setting values. Pressing the [VALUE] knob accepts the setting item that has been selected or applies the change made to a setting value.	
11	Heat-radiating ports	These release internal heat to inhibit temperature rises inside the VR-4HD. Heat-radiating ports are also found on the bottom panel. NOTE <ul style="list-style-type: none"> Never obstruct the heat-radiating ports. Obstructing the heat-radiating ports can result in temperature rises inside the VR-4HD, leading to risk of malfunction due to heat. 	—

Video Section

This section is for making picture transitions, compositing video, and making effect settings.

No.	Name	Explanation	Page			
12	[IN/OUT SETUP] button	This displays the input/output setup screen for video on the built-in monitor. Use this to specify the VIDEO IN connector to assign to video channel 4. Also use it to specify the video to output via the PVW OUT connector and the USB 3.0 port.	p. 15 p. 16			
13	[INPUT] button [OUTPUT] button	These switch the view mode of the built-in monitor and preview output (the PVW OUT connector).	p. 10 p. 18			
		<table border="1"> <tr> <td>[INPUT] button</td> <td>This displays the input video from the respective source devices as a four-way split screen. You can change the video by tapping the channel screen on the built-in monitor.</td> </tr> <tr> <td>[OUTPUT] button</td> <td>This displays the results of video mixing (main output video).</td> </tr> </table>		[INPUT] button	This displays the input video from the respective source devices as a four-way split screen. You can change the video by tapping the channel screen on the built-in monitor.	[OUTPUT] button
[INPUT] button	This displays the input video from the respective source devices as a four-way split screen. You can change the video by tapping the channel screen on the built-in monitor.					
[OUTPUT] button	This displays the results of video mixing (main output video).					
14	[VIDEO FX/KEY LEVEL] button	This displays on the built-in monitor the screen for adjusting the amount of filter effects applied and the degree of extraction for key composition.	p. 21 p. 24			
15	HDCP indicator	This lights up, flashes, or goes dark according to the VR-4HD's "HDCP" setting and the connected status of HDCP-compatible equipment.	p. 17			
16	[FREEZE] button	This stops (freezes) input video. The [FREEZE] button lights up during a freeze.	p. 20			
17	[PinP] button [SPLIT] button [QUAD] button	These select video composition effects. The selected button lights up during use.	p. 22 p. 23 p. 24			
		<table border="1"> <tr> <td>[PinP] button</td> <td>This composites video in an inset screen over a background video.</td> </tr> <tr> <td>[SPLIT] button</td> <td>This composites two video streams in a split screen.</td> </tr> <tr> <td>[QUAD] button</td> <td>This composites the input pictures on video channels 1 through 4 in a single screen.</td> </tr> </table>		[PinP] button	This composites video in an inset screen over a background video.	[SPLIT] button
[PinP] button	This composites video in an inset screen over a background video.					
[SPLIT] button	This composites two video streams in a split screen.					
[QUAD] button	This composites the input pictures on video channels 1 through 4 in a single screen.					
18	[CUT] button [MIX] button [WIPE] button	These select video transition effects. The selected button lights up.	p. 18			
		<table border="1"> <tr> <td>[CUT] button</td> <td>The picture switches instantly.</td> </tr> <tr> <td>[MIX] button</td> <td>The two pictures are blended together as the video is switched.</td> </tr> <tr> <td>[WIPE] button</td> <td>In this transition, the original video is broken into by the next video.</td> </tr> </table>		[CUT] button	The picture switches instantly.	[MIX] button
[CUT] button	The picture switches instantly.					
[MIX] button	The two pictures are blended together as the video is switched.					
[WIPE] button	In this transition, the original video is broken into by the next video.					
	[TIME] knob	This sets the video transition time (in seconds).	p. 18			
19	[OUTPUT FADE] button	<ul style="list-style-type: none"> This performs a fade-in or fade-out for the main output video. The [OUTPUT FADE] button indicates the status of the fade. Lighted: Fade-out Flashing: Fade-in/fade-out in progress Dark: Normal output This outputs a captured still image or a still image sent from the dedicated VR-4HD RCS program. 	p. 19 p. 20			
20	[KEY] button	This switches key composition on or off. When on, the [KEY] button lights up.	p. 24			
21	VIDEO INPUT SELECT [1]–[4] buttons	Use these buttons to switch the video. The selected button lights up indicating selected live channel.	p. 18			

Rear Panel/Side Panel (Connecting Your Equipment)

- * To prevent malfunction and equipment failure, always turn down the volume, and turn off all the units before making any connections.
- * Be sure to use cables and adaptor plugs with the proper connectors matching those of the other devices you are using.

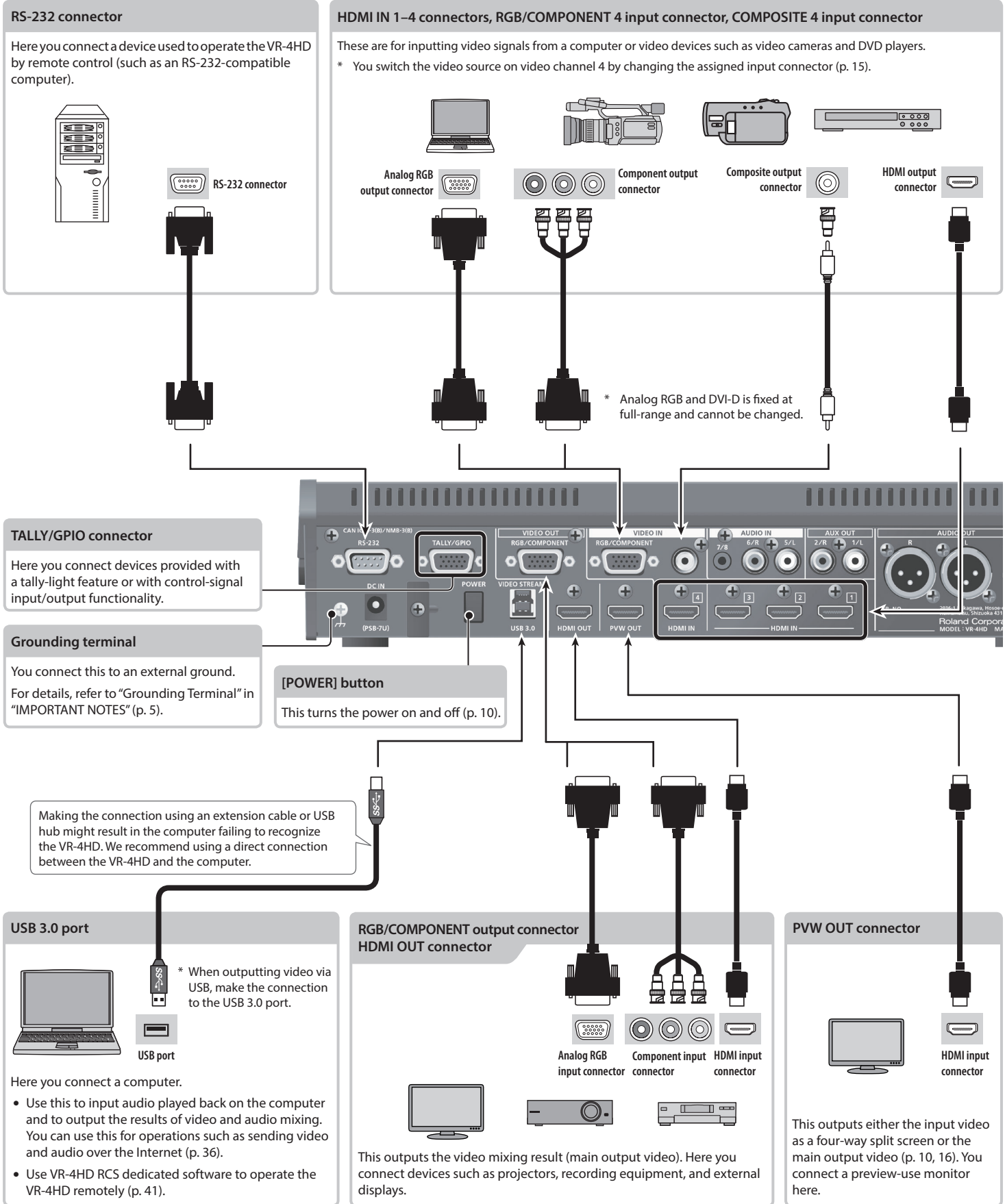

AUDIO IN 5/6 jacks, 7/8 jack

Here you input audio signals from video decks, CD players, and other such audio equipment.

AUDIO OUT connectors/jacks, AUX OUT jacks

These output the results of the audio mix. Here you connect an audio recording deck, amplifier, speakers, or other such equipment.

* The VR-4HD has two internal audio buses, and you can select the audio bus to output for each individual connector (p. 33).

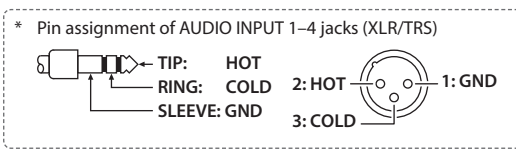
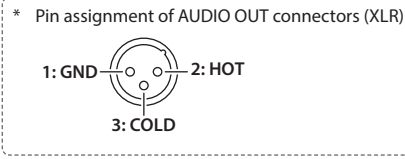
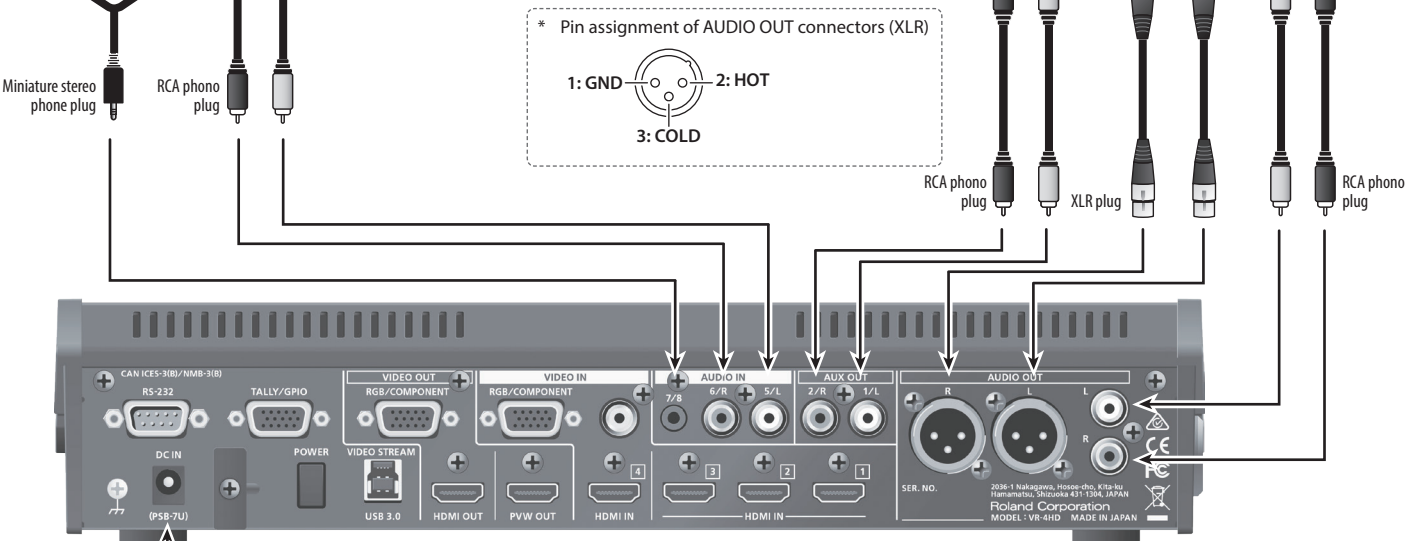

DC IN jack

This is for connecting the included AC adaptor.

Place the AC adaptor so the side with the indicator faces upwards and the side with printed information faces downwards. The indicator will light when you plug the AC adaptor into an AC outlet.

* To prevent the inadvertent disruption of power to your unit (should the plug be pulled out accidentally), and to avoid applying undue stress to the jack, anchor the power cord using the cord hook, as shown in the illustration.

DC IN (PSB-7U)

Cord hook

AUDIO INPUT 1-4 jacks (XLR/TRS)

These are for inputting audio signals from microphones, audio mixers, and other such audio equipment.

PHONES jack

This is for connecting headphones.

[PHANTOM] switches

The VR-4HD supports phantom power. When using a condenser microphone that requires phantom power, set the [PHANTOM] switch to "ON."

NOTE

- Always turn the phantom power off when connecting any device other than condenser microphones that require phantom power. You risk causing damage if you mistakenly supply phantom power to dynamic microphones, audio playback devices, or other devices that don't require such power. Be sure to check the specifications of any microphone you intend to use by referring to the manual that came with it. (This instrument's phantom power: 48 V DC, 10 mA Max)

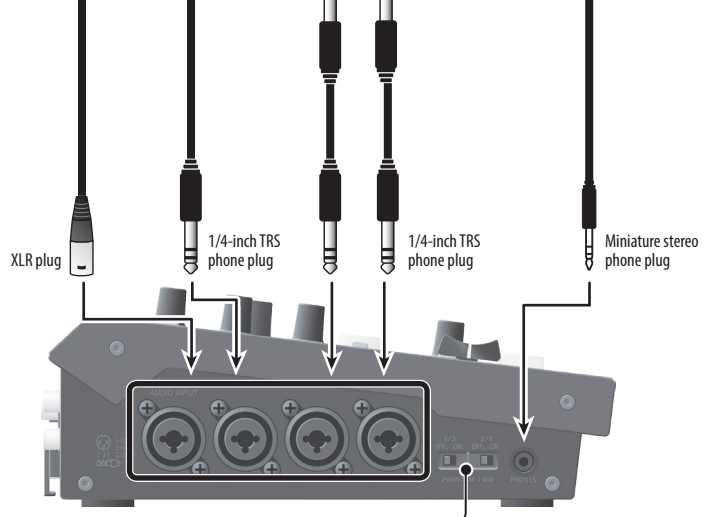

Basic Operations

Turning the Power On and Off

Once everything is properly connected (p. 8), be sure to follow the procedure below to turn on their power. If you turn on equipment in the wrong order, you risk causing malfunction or equipment failure.

- * Before turning the unit on/off, always be sure to turn the volume down. Even with the volume turned down, you might hear some sound when switching the unit on/off. However, this is normal and does not indicate a malfunction.

Turning the power on

1. Make sure all devices are turned off.
2. Press the [POWER] button on the rear panel of the VR-4HD to turn on the power.

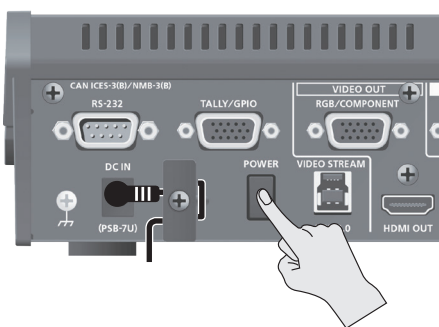

3. Turn on the power to the source devices.

Turn on the power to video cameras or other source equipment connected to input connectors on the VR-4HD.

4. Turn on the power to the output devices.

Turn on the power to projectors or other devices connected to output connectors on the VR-4HD.

Turning the power off

1. Turn off the power in the sequence of first the output equipment, and then the sources.
2. Press the [POWER] button on the VR-4HD to turn off the power.

About the Auto Off function

The power to the VR-4HD turns off automatically when all of the following states persist for 240 minutes (Auto Off function).

- No operation performed on the VR-4HD
 - No audio or video input
- * If you do not want the power to be turned off automatically, disengage the Auto Off function (p. 40).
- * When the power has been turned off by the Auto Off function, to restart, first press the [POWER] button to return it, then turn on the power.

NOTE

- Any settings that you are in the process of editing will be lost when the power is turned off. If you have any settings that you want to keep, you should save them beforehand.

Switching the View Mode of the Built-in Monitor and Preview Output

The VR-4HD's built-in monitor and preview output (the PVW OUT connector) have two types of view modes: the "input mode" and the "output mode."

MEMO

- Switching the view mode makes it change not only for the built-in monitor, but for preview output as well. Using the panel lock feature (p. 39) lets you lock the buttons to prevent accidental operation.

1. Press the [INPUT] or [OUTPUT] button to switch the view mode.

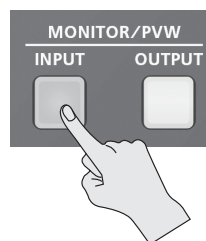

The selected button lights up and the view mode of the built-in monitor and preview output is changed.

[INPUT] button: Input mode

This displays video input from source equipment on a four-way split screen. The input video is arranged as shown below.



- * Labels identifying the input signals are displayed only on the built-in monitor. To display or hide the labels, use the [SYSTEM SETUP] button → <SYSTEM> → <INPUT CH LABEL DISPLAY> to make the setting.

[OUTPUT] button: Output mode

This displays the video currently being output.



MEMO

- You can select either "LOW" (dark) or "HIGH" (bright) as the brightness level of the built-in monitor. Use the [SYSTEM SETUP] button → <SYSTEM> → <LCD BRIGHTNESS> to select.
- You can hide the level meter displayed at the bottom of the screen. Use the [SYSTEM SETUP] button → <SYSTEM> → <LEVEL METER DISPLAY> to set the value to "OFF."

Working with Setup Screens (Menus)

Display for the various setup screens on the built-in monitor. In these menus change settings for video, audio and for general VR-4HD settings.

Displaying/Quitting Setup Screens

The VR-4HD has a number of different setup screens. There are different buttons for each setup screen that will bring up the parameters for that button onto the display screen.

1. Press one of the buttons shown below to display the respective setup screen.

The selected button lights up.

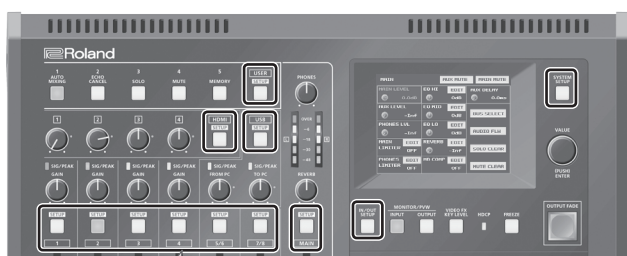

Button	Displayed setup screen
USER [SETUP]	USER button settings
HDMI [SETUP]	Settings for HDMI input audio
USB [SETUP]	Settings for USB input/output audio
Audio channel 1-7/8 [SETUP]	Settings for input audio
MAIN [SETUP]	Settings for main output audio
[IN/OUT SETUP]	Assignments to video input/output connectors
[SYSTEM SETUP]	Settings for the system (video, audio, and the unit)

2. Press the button you selected in step 1 once or several times to quit the setup screen.

MEMO

- Settings made at the setup screen are saved in the unit at the time when you quit the screen.
- You can adjust the contrast of the setup screen. Use the [SYSTEM SETUP] button → <SYSTEM> → <MENU DISPLAY LEVEL> to adjust it.
- The setup screen is displayed superimposed on the video on the built-in monitor. You can hide the video on the built-in monitor by pressing the lighted [INPUT] or [OUTPUT] button to make the button go dark.
- For more information about setting items, refer to the Reference Manual (PDF) available for download from the Roland website.
<https://proav.roland.com/>

Selecting a Setting Item

Two methods are available for selecting setting items: by operating the touch panel and by operating the [VALUE] knob.

Touch Panel Operation

1. Tap the setting item.

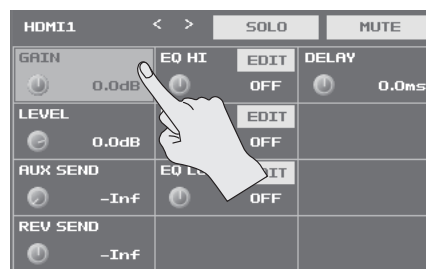

[VALUE] Knob Operation

1. Turn the [VALUE] knob to move the cursor to the setting item, then press the [VALUE] knob.

- The selected setting item is displayed with a red background.
- At the setup screen for the system, you first go to the bottom area of the screen and select the category, then select the setting item.
- The setup screens are composed of two or more pages. You can change the page by selecting <◀> or <▶> at the top of the screen.

Changing Setting Values

1. Turn the [VALUE] knob to change the setting value.



* You can change the setting value in larger steps by holding down the [VALUE] knob as you turn it.

- Pressing the [VALUE] knob returns you to the cursor view.
- You can turn on-screen on/off switches on and off by pressing the [VALUE] knob or by tapping the switch on the screen.
- When a setup screen is displayed, pressing and holding the [VALUE] knob (for 2 seconds or longer) returns the selected setting item to its default value.
- For the following setting items, changes are not applied until you press the [VALUE] knob to accept the setting.

Setup screen for the system ([SYSTEM SETUP] Button)	
Category	Setting item
VIDEO CH4	RESOLUTION (EDID)
	OUTPUT RESOLUTION
VIDEO OUT	OUTPUT COLOR SPACE
	OUTPUT DVI-D/HDMI
	PREVIEW COLOR SPACE
	PREVIEW DVI-D/HDMI
SYSTEM	HDCP
	FRAME RATE
	SYSTEM FORMAT

List of Supported Video Formats

Input Formats

Input connector	Frame rate	
	When set at "59.94 Hz"	When set at "50 Hz"
HDMI IN 1-3	720/59.94p	720/50p
	1080/59.94i	1080/50i
	1080/59.94p	1080/50p
HDMI IN 4	480/59.94i	576/50i
	480/59.94p	576/50p
	720/59.94p	720/50p
	1080/59.94i	1080/50i
	1080/59.94p	1080/50p
	640 x 480/60 Hz	640 x 480/60 Hz
	800 x 600/60 Hz	800 x 600/60 Hz
	1024 x 768/60 Hz	1024 x 768/60 Hz
	1280 x 768/60 Hz	1280 x 768/60 Hz
	1280 x 1024/60 Hz	1280 x 1024/60 Hz
	1366 x 768/60 Hz	1366 x 768/60 Hz
	1400 x 1050/60 Hz	1400 x 1050/60 Hz
	1600 x 1200/60 Hz	1600 x 1200/60 Hz
	1920 x 1200/60 Hz	1920 x 1200/60 Hz
RGB/COMPONENT 4 (component signal)	480/59.94i	576/50i
	480/59.94p	576/50p
	720/59.94p	720/50p
	1080/59.94i	1080/50i
	1080/59.94p	1080/50p
RGB/COMPONENT 4 (RGB signal)	640 x 480/60 Hz	640 x 480/60 Hz
	800 x 600/60 Hz	800 x 600/60 Hz
	1024 x 768/60 Hz	1024 x 768/60 Hz
	1280 x 768/60 Hz	1280 x 768/60 Hz
	1280 x 1024/60 Hz	1280 x 1024/60 Hz
	1366 x 768/60 Hz	1366 x 768/60 Hz
	1400 x 1050/60 Hz	1400 x 1050/60 Hz
	1600 x 1200/60 Hz	1600 x 1200/60 Hz
1920 x 1200/60 Hz	1920 x 1200/60 Hz	
COMPOSITE 4	480i	576i

* The refresh rates are the maximum value for each resolution.

Audio input format	Input connector	Input formats
	HDMI	Linear PCM, 24 bits/48 kHz, 2 ch
	USB	Linear PCM, 16 bits/48 kHz, 2 ch

Output Formats

Output connector	Frame rate	
	When set at "59.94 Hz"	When set at "50 Hz"
HDMI OUT	480/59.94i	576/50i
	480/59.94p	576/50p
	720/59.94p	720/50p
	1080/59.94i	1080/50i
	1080/59.94p	1080/50p
	640 x 480/60 Hz	640 x 480/75 Hz
	800 x 600/60 Hz	800 x 600/75 Hz
	1024 x 768/60 Hz	1024 x 768/75 Hz
	1280 x 768/60 Hz	1280 x 768/75 Hz
	1280 x 1024/60 Hz	1280 x 1024/75 Hz
	1366 x 768/60 Hz	1366 x 768/75 Hz
	1400 x 1050/60 Hz	1400 x 1050/75 Hz
	1600 x 1200/60 Hz	1600 x 1200/60 Hz
	1920 x 1200/60 Hz	1920 x 1200/60 Hz
RGB/COMPONENT (component signal) (*1)	480/59.94p	576/50p
	720/59.94p	720/50p
	1080/59.94p	1080/50p
RGB/COMPONENT (RGB signal)	640 x 480/60 Hz	640 x 480/75 Hz
	800 x 600/60 Hz	800 x 600/75 Hz
	1024 x 768/60 Hz	1024 x 768/75 Hz
	1280 x 768/60 Hz	1280 x 768/75 Hz
	1280 x 1024/60 Hz	1280 x 1024/75 Hz
	1366 x 768/60 Hz	1366 x 768/75 Hz
	1400 x 1050/60 Hz	1400 x 1050/75 Hz
	1600 x 1200/60 Hz	1600 x 1200/60 Hz
1920 x 1200/60 Hz	1920 x 1200/60 Hz	
PVW OUT	720/59.94p	720/50p
	1080/59.94i	1080/50i
	1080/59.94p	1080/50p
USB 3.0	720/29.97p (uncompressed)	720/25p (uncompressed)
	1080/29.97p (uncompressed)	1080/25p (uncompressed)

(*1) No component output is made at 480i/576i or 1080i.

Audio output format	Output connector	Output formats
	HDMI	Linear PCM, 24 bits/48 kHz, 2 ch
	USB	Linear PCM, 16 bits/48 kHz, 2 ch

About Input/Output Format Settings

The input/output format is set as shown below.

Input connector	Input formats
HDMI IN 1-3	This is set using the system format.
HDMI IN 4	This is automatically detected to match the connected equipment.
RGB/COMPONENT 4	You can also specify a desired input format.
COMPOSITE 4	For details, refer to "Setting the Input Format for Channel 4" (p. 14).

Output connector	Output formats
HDMI OUT	This is set using the system format. You can also specify a desired output format.
RGB/COMPONENT	For details, refer to "Setting the Output Format for Main Output" (p. 14).
PVW OUT	This is set using the system format.
USB 3.0	This is set using the system format.

* For information on how to set the system format, refer to "Setting the System Format" (p. 13).

Video Input/Output Settings

Setting the Video Input/Output Format

Set parameters for the input/output format to match the connected equipment.

Setting the System Format

On the VR-4HD, the input/output format is determined according to the system format. You set the input/output format to match the connected equipment.

System format setting	Input format (*1)	Output format	
	HDMI IN 1-3 connector	PVW OUT connector HDMI OUT connector (*2) RGB/COMPONENT output connector (*2)	USB 3.0 port
1080p	1080p, 1080i	1080p	1080p
1080i	1080p, 1080i	1080i	
720p	720p	720p	720p

(*1) For channel-4 input connectors (HDMI IN 4, RGB/COMPONENT 4, and COMPOSITE 4), you can specify an independent input format, regardless of the system format.

For details, refer to "Setting the Input Format for Channel 4" (p. 14).

(*2) For the HDMI OUT connector and the RGB/COMPONENT output connector, you can specify a desired output format. The output-format setting follows the system format only when set to "AUTO."

For details, refer to "Setting the Output Format for Main Output" (p. 14).

1. Press the [SYSTEM SETUP] button to display the setup screen.
2. Select <SYSTEM> to display the SYSTEM menu.
3. Select <SYSTEM FORMAT>.

SYSTEM	
HDCP	OFF
FRAME RATE	59.94Hz
SYSTEM FORMAT	1080p
AUTO SCAN	OFF
AUTO SCAN TIME	5sec
LCD BRIGHTNESS	HIGH
MENU DISPLAY LEVEL	13
BACK	DEC INC

4. Use the [VALUE] knob to set the system format to "1080p," "1080i," or "720p."
5. Press the [VALUE] knob to apply the setting.
 - * The change is not applied unless you press the [VALUE] knob to accept the setting.
6. Press the [SYSTEM SETUP] button several times to quit the setup screen.

MEMO

- You can check the formats of video being input and output at the setup screen displayed by pressing the [IN/OUT SETUP] button.

If the  icon is displayed, this indicates that video in a format that differs from the setting on the VR-4HD is being input.

Internal Processing

The VR-4HD's internal processing is progressive. Interlaced input video is automatically converted to a progressive signal.

The picture might appear jagged at this time, or the picture in a PinP inset screen or preview four-way split screen might waver. This is due to progressive conversion, and is not a malfunction.

The methods for converting an interlaced signal to a progressive signal are of two types: "BOB" and "WEAVE."

BOB	This interpolates the top field and bottom field, and unites them in a single frame. This is optimal for video that contains much movement.
WEAVE	This joins the top field and bottom field in a single frame. This is optimal for video that contains little movement.

To set the conversion method, use the [SYSTEM SETUP] button → <SYSTEM> → <DEINTERLACE MODE> to make the setting.

About Frame Rates

Frame rates which can be input and output are "59.94 Hz" and "50 Hz" (For output via the USB 3.0 port only, the possible frame rates are "29.97 Hz" and "25 Hz"). Inputting video at a frame rate other than these might result in no output or dropped frames.

To change the frame rate, press the [SYSTEM SETUP] button → <SYSTEM> → <FRAME RATE> → select "59.94 Hz" or "50 Hz," then press the [VALUE] knob.

Setting the Input Format for Channel 4

By factory default, the EDID assignment for channel 4 is "AUTO" (set so that EDID values of all inputtable formats are sent).

To specify an input format of your choice, change the setting of the EDID information being sent so that it matches the incoming video signal.

MEMO

- EDID information is not sent during component signal input.

1. Press the [SYSTEM SETUP] button to display the setup screen.
2. Select <VIDEO CH4> to display the VIDEO CH4 menu.
3. Select <RESOLUTION (EDID)>.

VIDEO CH4	
INPUT ASSIGN	HDMI
RESOLUTION <EDID>	AUTO
SCALING TYPE	FULL
H. POSITION	0
V. POSITION	0
H. SIZE	150%
V. SIZE	150%
BACK	DEC INC

4. Use the [VALUE] knob to set the input format (the EDID information to send).

Value	Video signal that is input (channel 4)	
	RGB/COMPONENT connector	HDMI connector
480/576i	480/576p	Component
720p	1080i	
1080p		
640 x 480	800 x 600	HDMI
1024 x 768	1280 x 768	
1280 x 1024	1366 x 768	
1400 x 1050	1600 x 1200	
1920 x 1200		
AUTO	EDID information for all inputtable formats is sent.	

5. Press the [VALUE] knob to apply the setting.
 - * The change is not applied unless you press the [VALUE] knob to accept the setting.
6. Press the [SYSTEM SETUP] button several times to quit the setup screen.

Setting the Output Format for Main Output

By factory default, the format of video output via the HDMI OUT connector and RGB/COMPONENT output connector is set to "AUTO" (the same format as the system format on page 13).

To specify an output format of your choice, change the setting to match the setting on the device receiving the output from the VR-4HD.

MEMO

- Output video from the HDMI OUT and RGB/COMPONENT output connectors all have the same video format. Selecting individual video formats for these is not possible.

1. Press the [SYSTEM SETUP] button to display the setup screen.
2. Select <VIDEO OUT> to display the VIDEO OUT menu.
3. Select <OUTPUT RESOLUTION>.

VIDEO OUT	
OUTPUT RESOLUTION	AUTO
SCALING TYPE	FULL
OUTPUT H. POSITION	0
OUTPUT V. POSITION	0
OUTPUT H. SIZE	100%
OUTPUT V. SIZE	100%
OUTPUT CONTRAST	0
BACK	DEC INC

4. Use the [VALUE] knob to set the output format.

Value	Video signal that is output	
	RGB/COMPONENT connector	HDMI connector
480/576i (*1)	480/576p	Component
720p	1080i (*1)	
1080p		
640 x 480	800 x 600	HDMI
1024 x 768	1280 x 768	
1280 x 1024	1366 x 768	
1400 x 1050	1600 x 1200	
1920 x 1200		
AUTO	Follows the system format setting (p. 13).	

(*1) The "480/576i" and "1080i" formats are supported for HDMI output only. When the setting is "480/576i" or "1080i," no video is output from the RGB/COMPONENT output connector.

5. Press the [VALUE] knob to apply the setting.
 - * The change is not applied unless you press the [VALUE] knob to accept the setting.
6. Press the [SYSTEM SETUP] button several times to quit the setup screen.

Assigning a Video Source to Channel 4

By factory default, input on channel 4 is set to "HDMI" (video input via the HDMI IN 4 connector). When you want to input video via a different connector, change this setting.

1. Press the [IN/OUT SETUP] button to display the setup screen.

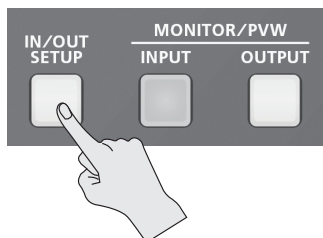

2. Select <CH4>.

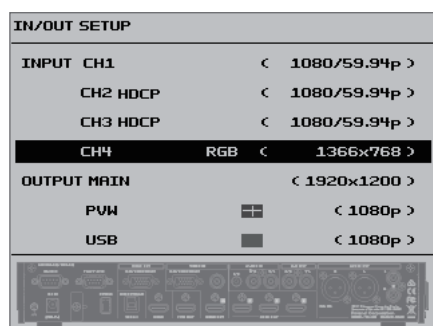

3. Use the [VALUE] knob to specify the video source to input on channel 4.

Value	Explanation
HDMI	Video is input via the HDMI IN 4 connector.
RGB	Video is input via the RGB/COMPONENT 4 connector.
COMPOSITE	Video is input via the COMPOSITE 4 connector.

4. Press the [IN/OUT SETUP] button to quit the setup screen.

MEMO

- You can also use the [SYSTEM SETUP] button → < VIDEO CH4 > → < INPUT ASSIGN > to specify the video source.

Adjusting Output Video

You adjust the main output video (HDMI OUT connector and RGB/COMPONENT output connector) or the preview output video (PVW OUT connector) to match the equipment receiving output from the VR-4HD.

MEMO

- You can output a color bar, useful for adjusting the image quality of a display. Use the [SYSTEM SETUP] button → <SYSTEM> → <COLOR BAR OUTPUT> to set the value to "ON."

1. Press the [SYSTEM SETUP] button to display the setup screen.
2. Select <VIDEO OUT> to display the VIDEO OUT menu.
3. Select the setting item.

VIDEO OUT	
OUTPUT RESOLUTION	AUTO
SCALING TYPE	FULL
OUTPUT H. POSITION	0
OUTPUT V. POSITION	0
OUTPUT H. SIZE	100%
OUTPUT V. SIZE	100%
OUTPUT CONTRAST	0
BACK	DEC INC

You use the following items to adjust the main output video.

Setting item	Explanation
OUTPUT RESOLUTION (*)	This sets the output format (p. 14).
SCALING TYPE	This sets the scaling type.
OUTPUT H. POSITION	This adjusts the display position in the horizontal direction.
OUTPUT V. POSITION	This adjusts the display position in the vertical direction.
OUTPUT H. SIZE	This adjusts the size in the horizontal direction.
OUTPUT V. SIZE	This adjusts the size in the vertical direction.
OUTPUT CONTRAST	This adjusts the contrast.
OUTPUT SATURATION	This adjusts the saturation.
OUTPUT BRIGHTNESS	This adjusts the brightness.
OUTPUT COLOR SPACE (*)	This sets the color space for HDMI OUT connector and RGB/COMPONENT output connector.
OUTPUT DVI-D/HDMI (*)	This sets the output mode for HDMI OUT connector.

You use the following items to adjust the preview output video.

Setting item	Explanation
PREVIEW CONTRAST	This adjusts the contrast.
PREVIEW SATURATION	This adjusts the saturation.
PREVIEW BRIGHTNESS	This adjusts the brightness.
PREVIEW COLOR SPACE (*)	This sets the color space for PVW OUT connector.
PREVIEW DVI-D/HDMI (*)	This sets the output mode for PVW OUT connector.

4. Use the [VALUE] knob to adjust the main output video or the preview output video.

* For setting items indicated by a "*" in the table above, you press the [VALUE] knob to apply the setting.

5. Press the [SYSTEM SETUP] button several times to quit the setup screen.

Adjusting the Input Video on Channel 4

For video input on channel 4, you can perform operations such as adjusting the image quality and setting the input format (EDID).

1. Press the [SYSTEM SETUP] button to display the setup screen.
2. Select <VIDEO CH4> to display the VIDEO CH4 menu.
3. Select the setting item.

VIDEO CH4	
INPUT ASSIGN	HDMI
RESOLUTION <EDID>	AUTO
SCALING TYPE	FULL
H. POSITION	0
V. POSITION	0
H. SIZE	150%
V. SIZE	150%
BACK	DEC INC

Adjust the following setting items.

Setting item	Explanation
RESOLUTION (EDID)	This sets the input format (EDID). → "Setting the Input Format for Channel 4" (p. 14).
SCALING TYPE	This sets the scaling type.
H. POSITION	This adjusts the display position in the horizontal direction.
V. POSITION	This adjusts the display position in the vertical direction.
H. SIZE	This adjusts the size in the horizontal direction.
V. SIZE	This adjusts the size in the vertical direction.
CONTRAST	This adjusts the contrast.
SATURATION	This adjusts the saturation.
BRIGHTNESS	This adjusts the brightness.
FLICK FILTER	This reduces flicker.

4. Use the [VALUE] knob to adjust the input video on channel 4.
5. Press the [SYSTEM SETUP] button several times to quit the setup screen.

Specifying the Video Output from the PVW OUT Connector/USB 3.0 Port

For the PVW OUT connector and USB 3.0 port, you can set the video that is output to either ① the main output video or ② the incoming video for four-way split screen (channels 1 through 4).

1. Press the [IN/OUT SETUP] button to display the setup screen.

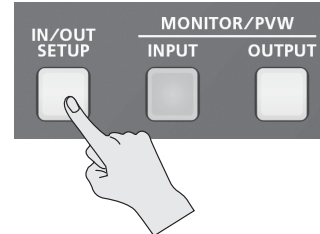

2. Select <PVW> or <USB>.

IN/OUT SETUP	
INPUT CH1	< 1080/59.94p >
CH2	< 1080/59.94p >
CH3	< 1080/59.94p >
CH4	RGB < 1366x768 >
OUTPUT MAIN	< 1920x1200 >
PVW	< 1080p >
USB	< 1080p >

3. Use the [VALUE] knob to set the output video.

Value	Explanation
<input type="checkbox"/>	The main output video is output.
<input checked="" type="checkbox"/>	The incoming video on channels 1 through 4 is output as a four-way split screen.

4. Press the [IN/OUT SETUP] button to quit the setup screen.

MEMO

- When you use the [INPUT] or [OUTPUT] button to switch the view mode for preview output, the "PVW" setting also changes. Using the panel lock feature (p. 39) lets you lock the buttons to prevent accidental operation.

Inputting Copyright-protected (HDCP) Video

To input copyright-protected (HDCP) video from a Blu-ray Disc player or the like, follow the steps described below to change the "HDCP" setting.

* The VR-4HD must be connected to an HDCP compatible display for HDCP protected video to be connected.

What's HDCP?

HDCP is copyright-protection technology that prevents unlawful copying of content by encoding the path when sending digital signals from a video playback device to a display monitor or other display equipment.

1. Press the [SYSTEM SETUP] button to display the setup screen.
2. Select <SYSTEM> to display the SYSTEM menu.
3. Select <HDCP>.

SYSTEM	
HDCP	OFF
FRAME RATE	59.94Hz
SYSTEM FORMAT	1080p
AUTO SCAN	OFF
AUTO SCAN TIME	5sec
LCD BRIGHTNESS	HIGH
MENU DISPLAY LEVEL	13
BACK	DEC INC

4. Use the [VALUE] knob to set this to "ON."

Value	Explanation
ON	Copyright-protected (HDCP) video can be input. HDCP is also added to the video that is output.
OFF	Copyright-protected (HDCP) video cannot be input.

5. Press the [VALUE] knob to apply the setting.

* The change is not applied unless you press the [VALUE] knob to accept the setting.

6. Press the [SYSTEM SETUP] button several times to quit the setup screen.

Checking HDCP-compatible Equipment

When "HDCP" is set to "ON," you can check the status of HDCP compatibility for connected equipment by examining the setup screen that appears when you press the [IN/OUT SETUP] button.

"HDCP" is displayed on screen according to the status of HDCP support.

IN/OUT SETUP	
INPUT CH1	< 1080/59.94p >
CH2	HDCP < 1080/59.94p >
CH3	HDCP < 1080/59.94p >
CH4	RGB < 1366x768 >

Connector	HDCP support status
HDMI IN connector	Copyright-protected (HDCP) video is being input.
HDMI OUT connector	An HDCP-compatible device is connected.
PVW OUT connector	

Output from Connectors

When "HDCP" is set to "ON," video is output only from the HDMI OUT and PVW OUT connectors.

No video is output via the RGB/COMPONENT connector and USB 3.0 port. Also, no audio is output from the USB 3.0 port.

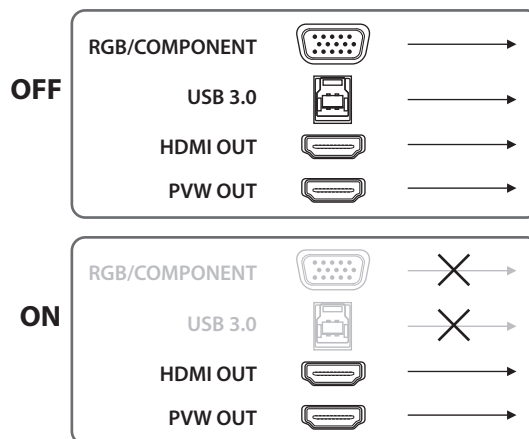

Operation of the HDCP indicator

The HDCP indicator operates as follows, regardless of input.



Indicator	"HDCP" setting	Connection status
Lighted	ON	An HDCP-compatible device is connected to the HDMI OUT or PVW OUT connector.
Flashing	ON	No HDCP-compatible device is connected to the HDMI OUT or PVW OUT connector. Alternatively, a device that does not support HDCP is connected.
Dark	OFF	—

Video Operations

Switching the Video

Switching between the video inputs via channels 1 through 4.

Switching by Tapping the Screen

You can change the video by tapping the channel screen on the built-in monitor

1. Press the [INPUT] button, making the button light up.

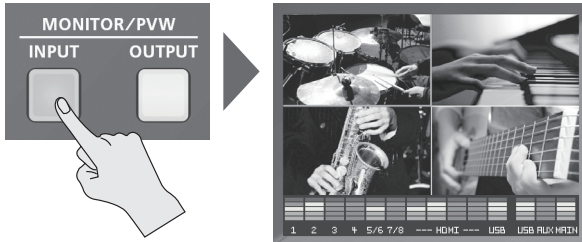

The incoming video on channels 1 through 4 are displayed on the built-in monitor as a four-way split screen. A red border is displayed around the channel screen being output.

MEMO

- Pressing the [INPUT] button to switch the view mode of the built-in monitor (p. 10) also changes the view mode of preview output in the same way.

2. Press the [CUT], [MIX], or [WIPE] button to select a transition effect.

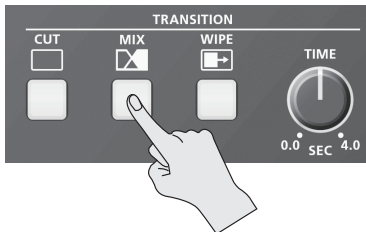

The selected button lights up.

Button	Explanation
[CUT]	The picture switches instantly.
[MIX]	The two pictures are blended together as the video is switched.
[WIPE]	In this transition, the original video is broken into by the next video.

MEMO

- You can change the transition pattern used for a wipe or mix transition. Use the [SYSTEM SETUP] button → <TRANSITION> → <MIX PATTERN> or <WIPE PATTERN> to make the setting. For a list of transition-pattern types, refer to "Transition Effects List" (p. 48).

3. Use the [TIME] knob to set the transition time.



When a mix or wipe has been selected as the transition effect, you can set a video transition time in a range of 0.0 to 4.0 seconds.

MEMO

- You can also set the transition time for video from the TRANSITION menu. Use the [SYSTEM SETUP] button → <TRANSITION> → <TRANSITION TIME> to make the setting.

4. Tap the screen for the channel you want to output.

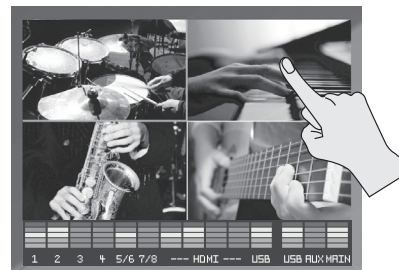

The video changes.

During the transition time while switching from one channel to another channel, red borders are displayed around the screens for both channels.

- * Tapping a different new channel screen while the video transition is in progress interrupts the transition and cuts to the new channel selected.

Switching the Video Using Buttons

Press the VIDEO INPUT SELECT [1]-[4] buttons to switch the video.

- Carry out steps 1 through 3 of "Switching by Tapping the Screen" earlier on this page.
- Press one of the VIDEO INPUT SELECT [1]-[4] buttons to select the channel you want to output.

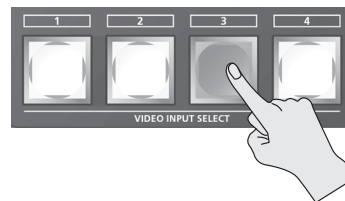

The video changes.

While the transition effect is being applied, the VIDEO INPUT SELECT button for the video after the transition flashes.

When the video has been switched completely, the button stops flashing and stays lighted.

- * Pressing a different new VIDEO INPUT SELECT button while the video transition is in progress executes the transition with a cut.

Switching Automatically (Auto Scan)

You can make the video on channels 1 through 4 switch automatically.

MEMO

- Any channels carrying no video input are skipped.

- Press the [SYSTEM SETUP] button to display the setup screen.
- Select <SYSTEM> to display the SYSTEM menu.
- Select <AUTO SCAN>.

SYSTEM	
HDCP	OFF
FRAME RATE	59.94Hz
SYSTEM FORMAT	1080p
AUTO SCAN	OFF
AUTO SCAN TIME	5sec
LCD BRIGHTNESS	HIGH
MENU DISPLAY LEVEL	13
BACK	DEC
	INC

- Use the [VALUE] knob to set this to "ON."

Value	Explanation
ON	Video automatic switching is turned on. The video on channels 1 through 4 is switched automatically.
OFF	The video automatic switching feature is turned off.

- You can set the interval for video display within the range of 1 to 120 seconds. Use the [SYSTEM SETUP] button → <SYSTEM> → <AUTO SCAN TIME> to make the setting.

- Press the [SYSTEM SETUP] button several times to quit the setup screen.

MEMO

- You can assign the Auto Scan function to a USER button and use the button to switch it on and off.

For information on how to use the USER buttons, refer to "Assigning Functions to USER Buttons" (p. 37).

Applying a Fade to the Main Output Video (Output Fade)

You can apply fade to the VR-4HD's main output video.

This lets you make the main output video fade to a black (or white) picture at times when you want to suppress video output, such as during intervals in a band performance.

- Press the [OUTPUT FADE] button to perform a fade-out.

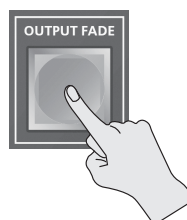

When the fade-out is complete, the [OUTPUT FADE] button lights up.

- To perform a fade-in, press the [OUTPUT FADE] button again.

When the fade-in is complete, the [OUTPUT FADE] button goes dark.

MEMO

- To set the fade time to fade-ins and fade-outs, use the [SYSTEM SETUP] button → <TRANSITION> → <TRANSITION TIME> to apply the setting.
- By factory default, the fade color is set to black. When you want to set the fade color to white, use the [SYSTEM SETUP] button → <VIDEO OUT> → set <OUTPUT FADE> to "WHITE."
- You can adjust the level of the fade color. Use the [SYSTEM SETUP] button → <VIDEO OUTPUT> → <OUTPUT FADE WHITE LEVEL> or <OUTPUT FADE BLACK LEVEL> to adjust.
- You can make the [OUTPUT FADE] button function as a still-image output button. Use the [SYSTEM SETUP] button → <VIDEO OUT> → <OUTPUT FADE> to set the value to "STILL."

For more information, refer to "Capturing a Still Image from Input Video" (p. 20).

Freezing Input Video (Freeze)

This temporarily pauses the incoming video.

When you are changing the connections between two computers during output, freezing the output before disconnecting the first computer and then ending the freeze after connecting the second computer makes it possible to change the connections without creating noise in the output.

Setting the Freeze Mode

Two operation modes are available for freezes: the "ALL mode" and the "SELECT mode."

By factory default, this is set to "ALL" (freeze all incoming video).

If you want to select the input video to freeze, use the [SYSTEM SETUP] button → <SYSTEM> → <FREEZE MODE> to set the value to "SELECT."

Freezing Input Video

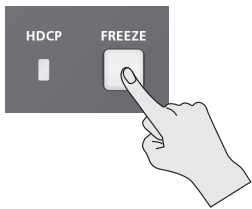

When the Freeze Mode Is Set to "ALL"

1. Press the [FREEZE] button to turn on freeze (lighted).
All video that is input freezes.
2. To turn off freeze, press the [FREEZE] button a second time.
The [FREEZE] button goes dark and normal output is resumed.

When the Freeze Mode Is Set to "SELECT"

1. Press the [FREEZE] button to turn on freeze (flashing).
The VIDEO INPUT SELECT [1] through [4] buttons all flash in red.
2. Press one of the VIDEO INPUT SELECT [1] through [4] buttons to select the incoming video you want to freeze.

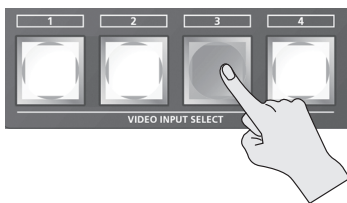

The selected input video freezes.

3. To turn off freeze, press the [FREEZE] button a second time.
The [FREEZE] button goes dark and normal output is resumed.

Capturing a Still Image from Input Video

You can capture still images from input video on channel 4. In addition to being able to output captured still images in the same way as video, you can also use them as a source for key compositing (p. 24).

* You can also use VR-4HD RCS dedicated software to send still images from a computer to the VR-4HD.

Capturing a Still Image

NOTE

- Either the captured still image or the still image sent from VR-4HD RCS is temporarily stored in the unit.

If a new still image is captured or is sent from VR-4HD RCS while a still image is already saved, the previously saved still image is overwritten. Also, still-image data is deleted when the power is turned off.

1. Input video on channel 4.
2. Press the [SYSTEM SETUP] button to display the setup screen.
3. Select <VIDEO CH4> to display the VIDEO CH4 menu.
4. Select <INPUT CAPTURE>.

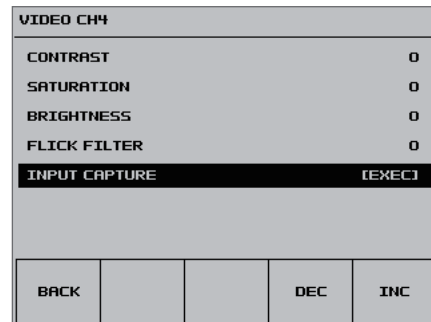

5. Check the message and select <OK>.
(If you want to quit, select <CANCEL>.)
Capturing is carried out, and the message "COMPLETE!" is displayed.
6. Press the [SYSTEM SETUP] button several times to quit the setup screen.

Outputting a Still Image

1. Change the functioning of the [OUTPUT FADE] button.
Use the [SYSTEM SETUP] button → <VIDEO OUT> → <OUTPUT FADE> to set the value to "STILL."
This makes the [OUTPUT FADE] button function as a still-image output button.

2. Press the [OUTPUT FADE] button.

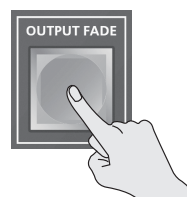

- * When you output a still image, the change is made using a cut, regardless of the transition-effect selection.
- * All output goes dark momentarily during the change, but this is not a malfunction.

The still image is output from the VR-4HD.

3. To return from still-image output to video output, press the [OUTPUT FADE] button once more.

Video Effect Operations

You can apply effects to the main output video. The VR-4HD has eight types of built-in filter effects and four types of built-in compositing effects.

Using Filter Effects

These apply effects such as changes in video color tone and appearance to the entire video.

Selecting a Filter Effect

1. Press the [SYSTEM SETUP] button to display the setup screen.
2. Select <VFX> to display the VIDEO FX menu.
3. Select <EFFECT PATTERN>.

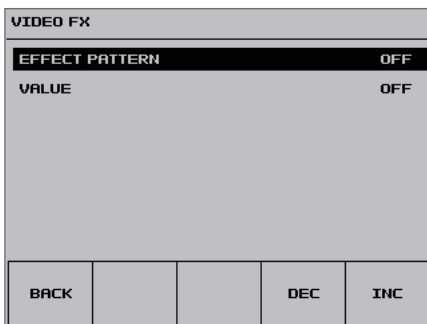

4. Use the [VALUE] knob to change the effect.

Value	Explanation
NEGATIVE	This inverts the brightness and colors.
EMBOSS	This adds a base-relief effect to the video.
COLORIZE	This adds color to the video.
COLOR PASS	This produces monochrome video with a specific color remaining.
POSTERIZE	This changes the gradations in brightness.
SILHOUETTE	This separates the video into light and dark areas, makes the dark areas black and adds a different color to the light areas.
MONOCOLOR	This produces monochrome video.
FINDEDGE	This extracts contours.
OFF	This assigns no effect.

5. Press the [SYSTEM SETUP] button several times to quit the setup screen.

Applying Filter Effects

1. Output the video to which you want to apply an effect (p. 18).
2. Press the [VIDEO FX/KEY LEVEL] button to display <VIDEO FX>.

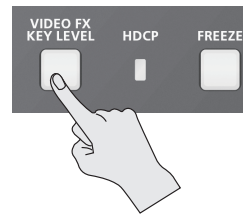

3. Select <VIDEO FX>, then use the [VALUE] knob to adjust the degree of effect applied.

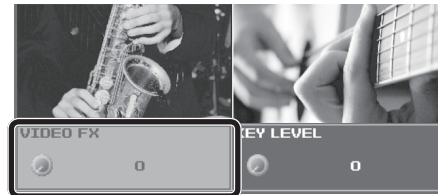

MEMO

- <VIDEO FX> is a shortcut for the [SYSTEM SETUP] button → <VFX> → <VALUE>.

4. If you want to turn off the effect, set <VIDEO FX> to "0" (zero).

MEMO

- Using the [SYSTEM SETUP] button → <VFX> → setting <EFFECT PATTERN> to "OFF" also turns off the effect.

5. Press the [VIDEO FX/KEY LEVEL] button to quit the <VIDEO FX> display.

Using Compositing Effects

This composites video.

Compositing Using Picture-in-Picture (PinP)

This composites video in an inset screen over a background video.

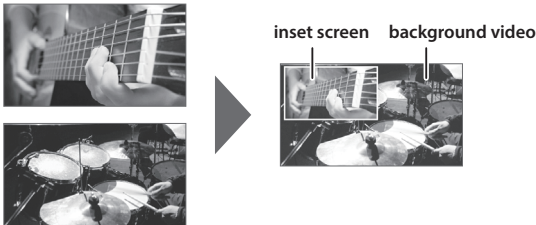

1. Press the [INPUT] button, making the button light up.

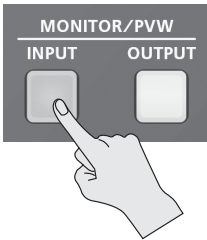

The incoming video on channels 1 through 4 is displayed on the built-in monitor as a four-way split screen.

2. Press the [PinP] button to turn on video compositing (making the button light up).

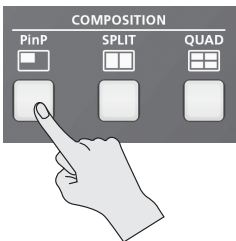

The VIDEO SELECT [1] through [4] buttons all flash in yellow.

3. Tap the channel screen you want to make the background video.

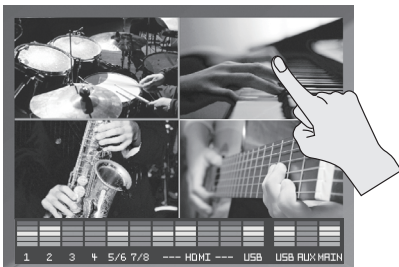

A red border is displayed around the selected channel screen.

4. Press one of the VIDEO INPUT SELECT [1] through [4] buttons to select the channel you want to make the inset screen.

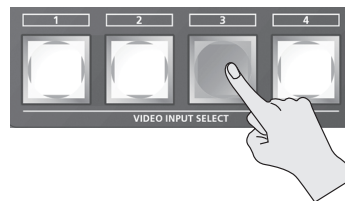

The selected button lights up in yellow. The inset screen is composited onto the background video and the result is output.

5. To turn off video compositing, press the [PinP] button a second time.

The [PinP] button goes dark and the inset screen disappears.

MEMO

- For the duration of the fade when the inset screen appears or disappears, the setting made using the [SYSTEM SETUP] button → <TRANSITION> → <TRANSITION TIME> is applied.
- While compositing of the video is in progress, the video switches with cuts regardless of the selected transition effect.

Making Detailed Settings for the Inset Screen

You can make more-advanced settings for the inset screen, such as changing its size and adding borders.

Use the [SYSTEM SETUP] button → <PinP> to make the settings for the following items.

Setting item	Explanation
SIZE	This sets the size of the inset screen (1/2, 1/3, or 1/4). The horizontal width (and vertical height) of the inset screen are set to 1/2, 1/3, or 1/4 the sizes values of the background video.
BORDER WIDTH	This adjusts the width of the border.
BORDER COLOR	This sets the color of the border.
PREVIOUS SELECT	When set to "ON," the channel of the previously selected inset screen is selected automatically when the [PinP] button is pressed.
H. POSITION	This adjusts the position in the horizontal direction.
V. POSITION	This adjusts the position in the vertical direction.

MEMO

- Pressing the [OUTPUT] button to change the view mode also lets you adjust the position of the inset screen by swiping it.

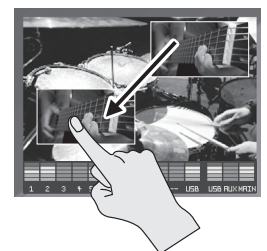

Compositing Using Split (SPLIT)

This composites two video streams in a split screen.

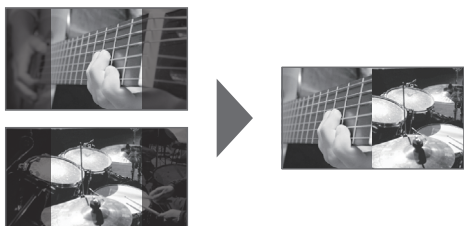

Specifying a Split Composition Pattern

Four patterns are available for split composition.

To change the pattern, the [SYSTEM SETUP] button → <SPLIT> → <PATTERN>.

Value	Explanation	
V. CENTER	This vertically crops the center section of the video.	
H. CENTER	This horizontally crops the center section of the video.	
V. STRETCH	This stretches the video vertically.	
H. STRETCH	This stretches the video horizontally	

Compositing Using Split

1. Press the [INPUT] button, making the button light up.

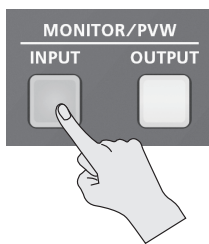

The incoming video on channels 1 through 4 is displayed on the built-in monitor as a four-way split screen.

2. Press the [SPLIT] button to turn on video compositing (making the button light up).

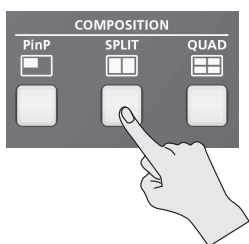

The VIDEO SELECT [1] through [4] buttons all flash in yellow.

3. Tap the channel screen you want to display above or on the left.

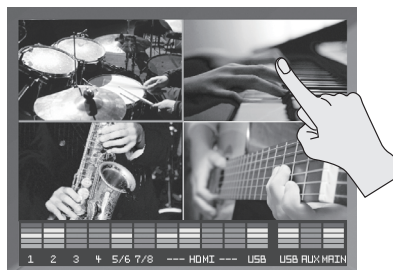

A red border is displayed around the selected channel screen.

4. Press one of the VIDEO INPUT SELECT [1] through [4] buttons to select the channel you want to display below or on the right.

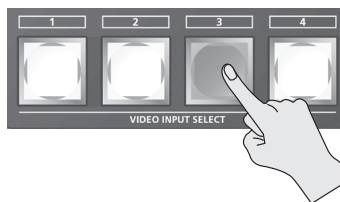

The selected button lights up in yellow. The video you selected in steps 3 and 4 is composited and output.

5. To turn off video compositing, press the [SPLIT] button a second time.

The [SPLIT] button goes dark and the lower half or right side of the screen disappears.

MEMO

- While compositing of the video is in progress, the video switches with cuts regardless of the selected transition effect.

Making Detailed Settings for Split Composition

You can make more-detailed settings, such as the cropping location for the video.

Use the [SYSTEM SETUP] button → <SPLIT> to make the settings for the following items.

Setting item	Explanation
PATTERN	This specifies the split composition pattern.
A-CENTER (*1)	<ul style="list-style-type: none"> When at V. CENTER This adjusts the horizontal position of the video displayed on the left. When at H. CENTER This adjusts the vertical position of the video displayed above.
B-CENTER (*1)	<ul style="list-style-type: none"> When at V. CENTER This adjusts the horizontal position of the video displayed on the right. When at H. CENTER This adjusts the vertical position of the video displayed below.
PREVIOUS SELECT	When set to "ON," the previously selected channel is selected automatically when the [SPLIT] button is pressed. * Only the channel displayed to the right or below is automatically selected.

(*1) This is applied when "PATTERN" is set to "V. CENTER" or "H. CENTER."

Compositing Four Video Streams on a Single Screen (QUAD)

This composites the input video on channels 1 through 4 into one screen.

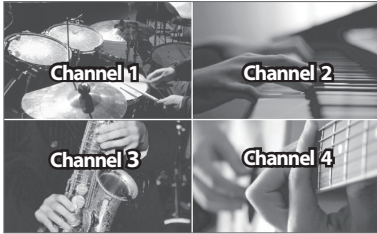

1. Press the [QUAD] button to turn on video compositing (making the button light up).

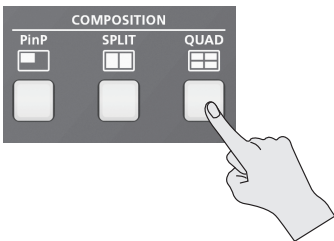

The input video on channels 1 through 4 is composited into one screen.

2. To turn off video compositing, press the [QUAD] button a second time.

The [QUAD] button goes dark and normal output returns.

Compositing Using Key

This makes a portion of the video transparent and composites it onto a background video.

With key composition on the VR-4HD, you can take video that has been composited using Picture-in-Picture and the like, and further composite it with text or other video.

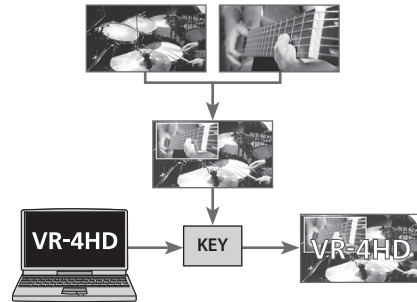

For instance, you can carry out two-screen composition of live video feed from two cameras, then use key composition to add a program logo input from a computer.

Luminance Key

This takes video in which white or black areas are made transparent, and composite it overlaid on a background picture.

Using luminance keying lets you superimpose logos or text on a background picture.



Chroma Key

This composites video shot against a blue or green background onto a different background video.

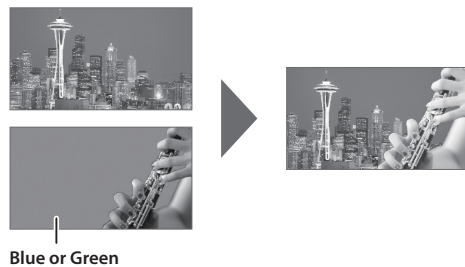

Setting the Key Type and Extraction Color

To change the key type and extraction color to match the video you want to composite.

Use the [SYSTEM SETUP] button → <KEY> to make the settings for the following items.

Setting item	Explanation
KEY TYPE	This selects between "CHROMA" (chroma key) or "LUMI" (luminance key) as the key type.
CHROMA KEY COLOR	This selects between "GREEN" or "BLUE" as the extraction color for chroma keying.
LUMI KEY COLOR	This selects between "WHITE" or "BLACK" as the extraction color for luminance keying.

Compositing Using Key

1. Input the logo or video.

By factory default, the settings are such that text and video input on channel 4 are used in key composition.

When you want to use text or video input on another channel, use the [SYSTEM SETUP] button → <KEY> → <KEY SOURCE CH> to change the channel.

If you want to perform compositing using a captured still image (p. 20) or a still image sent from VR-4HD RCS dedicated software, change the setting to "STILL."

MEMO

- The selected channel (the channel shown in the foreground in key composition) is displayed on the channel screen with a KEY icon.



- You can disable operation of the [KEY] button by setting <KEY SOURCE CH> to "OFF."

2. Press the [INPUT] button, making the button light up.

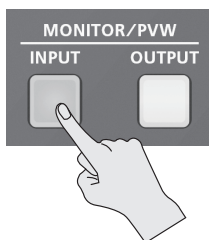

The incoming video on channels 1 through 4 is displayed on the built-in monitor as a four-way split screen.

3. Tap the channel screen you want to make the background video.

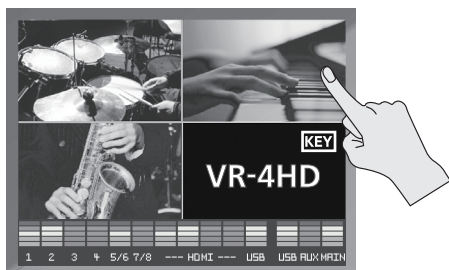

A red border is displayed around the selected channel screen.

4. Press the [KEY] button to turn on key composition (making the button light up).

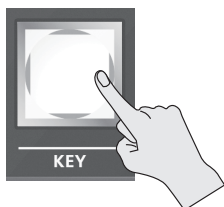

The video you selected in steps 1 and 3 is composited and output.

5. Press the [VIDEO FX/KEY LEVEL] button to display <KEY LEVEL>.



6. Select <KEY LEVEL> and use the [VALUE] knob to adjust the amount of keying.

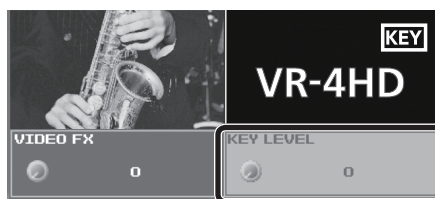

MEMO

- <KEY LEVEL> is a shortcut for the [SYSTEM SETUP] button → <KEY> → <CHROMA KEY LEVEL> or <LUMI KEY LEVEL>.

7. Press the [VIDEO FX/KEY LEVEL] button to quit the <KEY LEVEL> display.

8. To turn off key compositing, press the [KEY] button a second time.

The [KEY] button goes dark and the text or video displayed in the foreground disappears.

NOTE

- Chroma-key composition sometimes leaves color or small artifacts at the edges of the extracted video, but this is not a malfunction.

MEMO

- For the duration of the fade for the key-composited text or video, the setting made using the [SYSTEM SETUP] button → <TRANSITION> → <TRANSITION TIME> is applied.

Making Advanced Settings for Chroma Key

You can adjust degree of edge blur of the picture displayed in the foreground and fine-tune the values for hue and saturation.

Use the [SYSTEM SETUP] button → <KEY> to make the settings for the following items.

Setting item	Explanation
CHROMA KEY GAIN	This adjusts the degree of edge blur for the foreground video.
CHROMA KEY HUE WIDTH	This adjusts the hue width (range).
CHROMA KEY HUE FINE	This adjusts the center position for hue.
CHROMA KEY SAT WIDTH	This adjusts the saturation width (range).
CHROMA KEY SAT FINE	This adjusts the center position for saturation.

Making Advanced Settings for Luminance Key

You can adjust the degree of edge blur of the text or video displayed in the foreground.

Use the [SYSTEM SETUP] button → <KEY> to make the settings for the following items.

Setting item	Explanation
LUMI KEY GAIN	This adjusts the degree of edge blur for the foreground video or text.

Audio Operations

Adjusting the Volume Level of Input Audio

You can adjust the input sensitivity, sound position, and volume balance of audio input to the VR-4HD.

Adjusting Input Gain

Adjust the input gain (head amp gain or digital gain) so that incoming audio signals are at appropriate levels.

- * Head amp gain can be adjusted only for channels 1 through 4.
- * Manipulate the knob or fader for the corresponding input connector.

Head Amp Gain (Channels 1–4)

You adjust the head amp gain so that incoming audio signals on channels 1 through 4 are at appropriate levels.

1. Turn the [GAIN] knob all the way counterclockwise to turn down the input sensitivity.

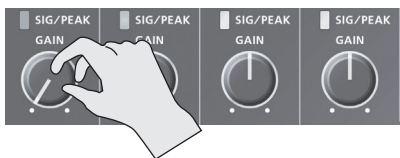

2. Move the channel fader to near the “Bold line” (0 dB—see the figure below).

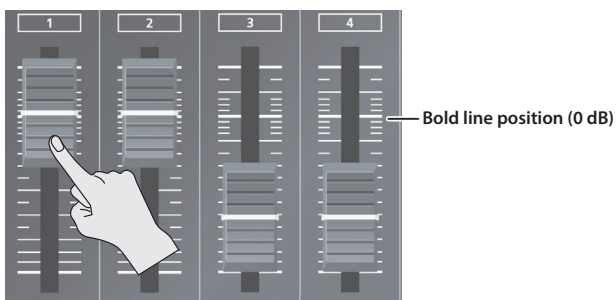

3. Raise the [MAIN] fader to an appropriate position.
4. Slowly turn the [GAIN] knob clockwise to adjust the input gain.

Use the [GAIN] knob to gradually raise the input gain as you play the actual incoming signal. Boost the input gain as high as possible without making the SIG/PEAK indicator light up in red.

A level at which the level meter lights up in yellow is appropriate.

Level Meter and SIG/PEAK Indicator Display

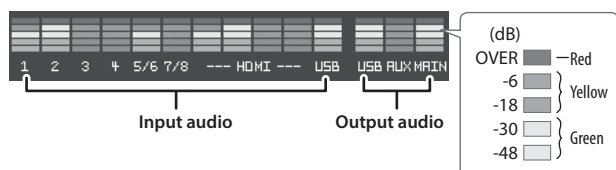

Indicator	Status
Red	This lights up at -3 dB or higher. It indicates an excessive volume level.
Yellow	This lights up at -18 dB or higher. It indicates an appropriate volume level.
Green	This lights up at -48 dB or higher. It indicates a too-low volume level.

Digital Gain

Adjust the digital gain so that audio signals input via channels 1 through 7/8, HDMI 1 through 4, and USB are at appropriate levels.

- * For channels 1 through 4, first adjust the head amp gain, and then adjust the digital gain as needed.

1. Move the volume knob or channel fader for the incoming audio whose input gain you want to adjust to the position shown below.

HDMI 1–4 and USB

Move the corresponding HDMI [1] to [4] knob or the [FROM PC] knob to near the indicator (0 dB—see the figure below).

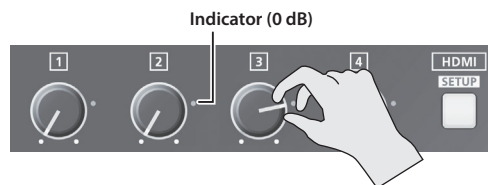

Channels 1–7/8

Move the channel fader to near the “Bold line” (0 dB—see the figure at left).

2. Raise the [MAIN] fader to an appropriate position.
3. Press the [SETUP] button for the incoming audio whose input gain you want to adjust, making the setup screen appear.
4. Select <GAIN>, then turn the [VALUE] knob all the way counterclockwise to lower the input gain completely.



5. Slowly turn the [VALUE] knob clockwise to adjust the input gain.

Use the [VALUE] knob to gradually raise the input gain as you play the actual incoming signal. A level at which the level meter lights up in yellow is appropriate.

6. Press the [SETUP] button to quit the setup screen.

Adjusting the Sound Position (Pan)

The left-right position of audio is called the sound position (pan). On the VR-4HD, you can adjust the sound position of sources connected to AUDIO INPUT jacks 1 through 4 on the side panel.

This lets you broaden the sound by moving its sound position farther to the left and right at times such as when you're transmitting feed of a performance using two microphones.

1. Press the [SETUP] button for the channel whose sound position you want to adjust, making the setup screen appear.
2. Select <PAN>, then use the [VALUE] knob to adjust the sound position.



3. Press the [SETUP] button to quit the setup screen.

Adjusting the Volume Balance

This adjusts the volume balance of audio input into the VR-4HD.

1. Raise and lower the channel faders to adjust the volume balance on the respective channels

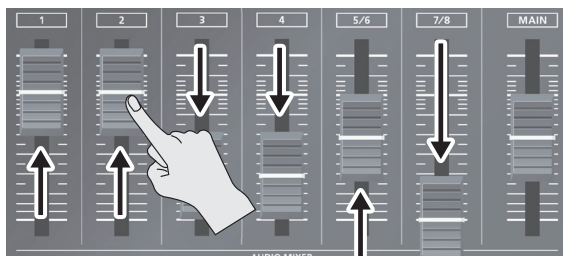

Raise the fader for a channel you want to make more prominent, such as, for example, a presenter's microphone, and lower the faders for other channels.

On channels that have no input or that carry audio that is not for output, lower their faders all the way.

2. Use the HDMI [1] through [4] knobs to adjust the volume level of HDMI audio.



When you aren't using HDMI audio, turn the HDMI [1] through [4] knobs all the way counterclockwise to lower the volume level completely.

3. Use the [FROM PC] knob to adjust the volume level of USB input audio.



When you're not using USB input audio, turn the [FROM PC] knob all the way counterclockwise to lower the volume level completely.

Adjusting the Volume Level of Main Output Audio

This adjusts the volume level of the main output audio.

1. See the level meter to check the volume level of the main output audio.

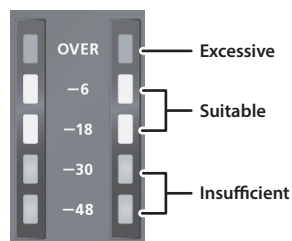

If OVER lights up, the volume level is excessive.

If only the indicators up to -48 or -30 light up, the volume level is insufficient.

2. Raise or lower the [MAIN] fader to adjust the volume level.

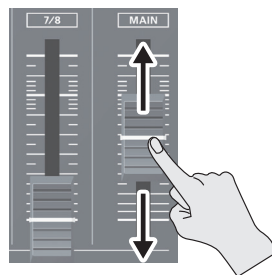

A level at which indicators "-18" through "-6" light up is appropriate.

NOTE

- If the volume level of speaker output is not suitable even after adjustment so that -18 to -6 light up, adjust the volume for the speakers or the amplifier. Using the [MAIN] fader to carry out further adjustment might result in distortion or degradation of sound quality.

Adjusting the Volume Level of USB Output Audio

This adjusts the volume level of audio output from the USB 3.0 port.

1. Use the [TO PC] knob to adjust the volume level.



You can check whether the volume level has been adjusted appropriately by examining the colors with which the SIG/PEAK indicator and level meter light up.

A level at which they light up in yellow is appropriate.

Applying Effects to Audio

You can apply effects to audio that is input and output to adjust its sound quality.

Applying Effects to Input Audio

This applies effects to input audio and adjusts the sound quality. The effects you can use are shown in the table below.

Input audio	Effects			
	Equalizer	Gate	Compressor	High-pass Filter
Channel 1–4	✓	✓	✓	✓
Channel 5/6, 7/8	✓	—	—	—
HDMI 1–4	✓	—	—	—
USB	✓	—	—	—

1. Press the [SETUP] button for the input audio to which you want to apply an effect, making the setup screen appear.
2. Select the setting item for the effect you want to use, then use the [VALUE] knob to adjust the value.



- Selecting <EDIT> displays a popup dialog box for detailed settings.
- For more information about effects, refer to the following section.

3. Press the [SETUP] button to quit the setup screen.

NOTE

- When the popup dialog box for detailed settings is displayed, on-screen setting values do not change when the [GAIN] knobs, faders or other controls are operated.

Equalizer (EQ)

This adjusts the sound quality for each frequency band.

Setting item	Explanation
EQ HI	This boosts or attenuates the high band.
EQ MID	This boosts or attenuates the middle band.
EQ LO	This boosts or attenuates the low band.
FREQ (HI, MID, LO)	This adjusts the center frequency for changing sound quality.
Q (MID)	This adjusts the width of the frequency band when boosting or attenuating the middle band.

Gate (GATE)

This removes audio that is below a specified level.

Setting item	Explanation
GATE	This sets gate on or off.
THRESHOLD	This sets the level used as the threshold for removing audio. Audio below the level set here is removed.
RELEASE	This adjusts the length of time until the audio is fully attenuated after audio falls below the threshold.

Compressor (COMP)

This compresses the audio.

Setting item	Explanation
COMP	This sets the compressor on or off.
THRESHOLD	This sets the level used as the threshold at which the compressor is applied. Compression is applied to audio that exceeds the threshold.
RATIO	This specifies the degree of compression applied to the audio. The state in which no compression is applied is defined as "1."
ATTACK	This sets the time until compression starts when audio exceeding the threshold is input.
RELEASE	This adjusts the length of time until compression ends after audio falls below the threshold.
AUTO GAIN	This switches the auto makeup gain feature on and off. When this is set to "ON," the final output volume level after applying the compressor is automatically adjusted according to the "THRESHOLD" and "RATIO" settings. The total of the "MAKEUP GAIN" setting value described below and the value calculated by auto makeup gain becomes the final output volume level (up to +34 dB).
MAKEUP GAIN	This adjusts the final output volume level after applying the compressor.

High-pass Filter (HPF)

This cuts off unneeded low-band audio. The cutoff frequency is 75 Hz.

Setting item	Explanation
HPF	This sets the high-pass filter on or off.

Applying Effects to Main Output Audio

You can apply effects (Reverb, Equalizer, Limiter, and Multi-band Compressor) to main output audio to adjust its sound quality.

1. Press the MAIN [SETUP] button to display the setup screen.
2. Select the setting item for the effect you want to use, then use the [VALUE] knob to adjust the value.



- Selecting <EDIT> displays a popup dialog box for detailed settings.
- For more information about effects, refer to the following section.

3. Press the MAIN [SETUP] button to quit the setup screen.

NOTE

- When the popup dialog box for detailed settings is displayed, on-screen setting values do not change when the [REVERB] knob, [MAIN] fader or other controls are operated.

Equalizer (EQ)

This adjusts the sound quality for each frequency band.

Setting item	Explanation
EQ HI	This boosts or attenuates the high band.
EQ MID	This boosts or attenuates the middle band.
EQ LO	This boosts or attenuates the low band.
FREQ (HI, MID, LO)	This adjusts the center frequency for changing sound quality.
Q (MID)	This adjusts the width of the frequency band when boosting or attenuating the middle band.

Multi-band Compressor (MB COMP)

This applies separate compressors in individual frequency bands.

Setting item	Explanation
MB COMP	This switches the multi-band compressor on and off.
HI THRES MID THRES LO THRES	These set the individual levels that become the thresholds for the high, midrange, and low bands at which the compressor is applied. Compression is applied to audio that exceeds the threshold.
HI RATIO MID RATIO LO RATIO	These set the amount of compression applied in the high, midrange, and low bands. The state in which no compression is applied is defined as "1."

Limiter (LIMITER)

This compresses audio input that is too high, thereby preventing distortion.

Setting item	Explanation
MAIN LIMITER	This sets the limiter on or off.
THRESHOLD	This sets the level that becomes the threshold at which the limiter is applied. Compression is applied to audio that exceeds the threshold. The volume level of audio that is output is limited so as to stay to below the threshold.

* You can also make the setting for <PHONES LIMITER> to apply the limiter to audio output to headphones.

Reverb (REVERB)

This adds lingering reverberations to the audio. You can apply reverb to audio input via channels 1 through 7/8, HDMI 1 through 4, and USB.

Setting item	Explanation
REVERB	This adjusts the return level from reverb of the audio. * You can also use the [REVERB] knob on the top panel to adjust this.
TIME	This adjusts the length of the reverb.
TYPE	This specifies the type of reverb (Room or Hall). Room: Produces the natural reverberations of a highly resonant room. Hall: Produces reverberations like that of a performance in a concert hall or other such space.

1. Press the [SETUP] button for the input audio to which you want to apply reverb, making the setup screen appear.
2. Select <REV SEND>, then use the [VALUE] knob to adjust amount of audio sent to reverb.



You can set the send level of audio to Reverb for each separate input-audio stream, which lets you adjust the degree of reverb individually.

3. Turn the [REVERB] knob to adjust the return level of audio from Reverb.

This adjusts the depth of overall reverb applied while maintaining the balance in the degree of reverb applied to the individual input-audio streams.

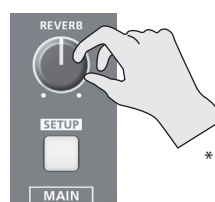

* Turning the [REVERB] knob all the way counterclockwise results in no reverb applied.

4. Press the [SETUP] button to quit the setup screen.

Hearing Only Specific Input Audio (Solo/Mute)

You can temporarily monitor specific input audio via headphones (Solo feature).

You can also temporarily silence specific input audio or output audio (mute feature).

* The Solo feature affects output to headphones. It has no effect on non-headphones audio output.

Solo/Mute for Input Audio

1. Press the [SETUP] button for the input audio where you want to make the setting for Solo or Mute, making the setup screen appear.
2. Select <SOLO> or <MUTE> to switch the setting on or off.



Setting item	Explanation
SOLO	When this is on, the <SOLO> indicator changes to blue. You can hear just the input audio for which this is turned on through the headphones.
MUTE	When this is on, the <MUTE> indicator changes to red. The input audio for which this is turned on is muted out.

3. Press the [SETUP] button to quit the setup screen.

Muting Output Audio

This mutes audio on the MAIN bus or AUX bus (p. 33).

1. Press the MAIN [SETUP] button to display the setup screen.
2. Select <MAIN MUTE> or <AUX MUTE> to switch the setting on (red) or off.



3. Press the MAIN [SETUP] button to quit the setup screen.

MEMO

- When muting audio output via USB, use the USB [SETUP] button → at the USB TO PC page, switch <MUTE> on and off.

Turning Off Solo/Mute Globally

This turns off the setting for Solo or Mute globally.

1. Press the MAIN [SETUP] button to display the setup screen.
2. Select <SOLO CLEAR> or <MUTE CLEAR>.



When all Solo or Mute settings have been turned off, the <SOLO CLEAR> or <MUTE CLEAR> indication is grayed out.

3. Press the MAIN [SETUP] button to quit the setup screen.

MEMO

- You can assign the Solo and Mute features to USER buttons and switch them on and off in the following ways.
 - Assign audio signals to a group and switch the Solo or Mute feature on and off for the group.
 - Display all Solo buttons and switch the Solo feature on and off. You can also perform the same kind of operation using the Mute feature.

For information on how to use the USER buttons, refer to "Assigning Functions to USER Buttons" (p. 37).

Checking Solo/Mute Status

The status of Solo and Mute is displayed beneath the level meter. When Solo or Mute is turned on, the area lights up as shown below.



Eliminating Echo in Web Conferencing Systems (Echo Cancel)

In web conferencing calls using conferencing system speakers and microphones, echo occurs when the microphone picks up and returns the voice of the other party coming from the speaker.

Using the Echo Cancel feature makes it possible to eliminate the echo component from audio picked up by the microphone connected to the VR-4HD and send only your own voice to the other party.

The Echo Cancel feature is provided on channels 1 through 4, and is executed independently for each channel. The appropriate processing is performed for each channel even when microphones of different types are used at the same time or when individual microphones are placed at different locations.

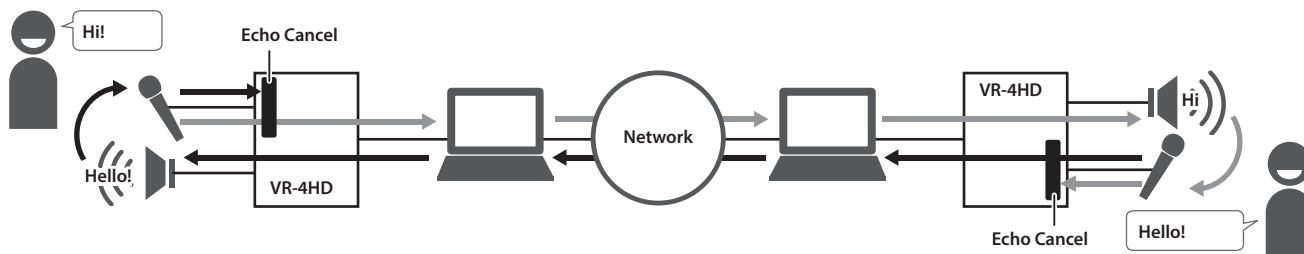

1. Press the [SYSTEM SETUP] button to display the setup screen.
2. Select <AUDIO> to display the AUDIO menu.
3. Select <ECHO CANCEL SETUP> to display the ECHO CANCEL screen.

AUDIO	
AUTO MIXING SW	OFF
AUTO MIXING SETUP	[EDIT]
ECHO CANCEL SW	OFF
ECHO CANCEL SETUP	[EDIT]
AUDIO FOLLOW SW	OFF
AUDIO FOLLOW SETUP	[EDIT]
BACK	DEC
	INC

4. Set the Echo Cancel switch to "ON."

ECHO CANCEL	
	ON
CH1 DEPTH	5
CH2 DEPTH	5
CH3 DEPTH	5
CH4 DEPTH	5
CH1 SW	ON
CH2 SW	ON
CH3 SW	ON
CH4 SW	ON

The Echo Cancel feature is turned on.

5. Select a switch from <CH1 SW> to <CH4 SW>, then use the [VALUE] knob to set the channel where you want to use Echo Cancel to "ON."

Value	Explanation
ON	Echo Cancel is used.
OFF	Echo Cancel is not used. On channels where Echo Cancel is not required, set this to "OFF."

6. Select a value from <CH1 DEPTH> to <CH4 DEPTH>, then use the [VALUE] knob to set the intensity of the Echo Cancel effect (from 1 to 10) for the respective channel.

Set this to the value that yields the most reduction of echo.

7. Press the [SYSTEM SETUP] button several times to quit the setup screen.

MEMO

- The Echo Cancel feature accommodates rooms of approximately 20 square meters.
- If you hear your own voice come back to you, you might need to have the other party make the setting for Echo Cancel.
- Assigning the Echo Cancel feature to a USER button lets you use the button to switch the feature on and off.
For information on how to use the USER buttons, refer to "Assigning Functions to USER Buttons" (p. 37).
- You can also switch the Echo Cancel feature on and off by using the [SYSTEM SETUP] button → <AUDIO> → making the setting for <ECHO CANCEL SW>.

Controlling Fader Operation Automatically (Auto Mixing)

This automatically controls fader operations that normally are performed by an operator (Auto Mixing feature). It lets you rely on the VR-4HD to perform complex fader operations, enabling use in circumstances where no dedicated operator is assigned. This is especially useful for meetings, discussions, debates, and other situations where multiple microphones are used.

1. Follow the procedure in "Adjusting Input Gain" (p. 26) to adjust the input gain for channels 1 through 7/8 and HDMI 1 through 4.
2. Press the [SYSTEM SETUP] button to display the setup screen.
3. Select <AUDIO> to display the AUDIO menu.
4. Select <AUTO MIXING SETUP> to display the AUTO MIXING screen.

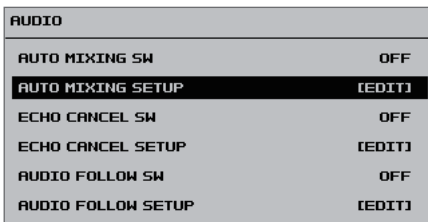

5. Set the Auto Mixing switch to "ON."

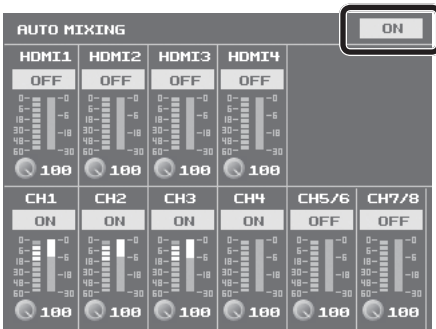

The Auto Mixing feature is switched on.

6. Use the channel switches to set the channels where Auto Mixing is to be used to "ON."

CH1	Value	Explanation
	ON	Auto Mixing is used.
	OFF	Auto Mixing is not used. Set channels where Auto Mixing is not needed, such as background music channels, to "OFF."

Level Meters

- 1 This indicates the Auto Mixing input level. This is the level after passing through weight control.
- 2 This indicates the Auto Mixing level. This is the level of the internal Auto Mixing faders operated by the mixer itself.

- 3 Channel faders HDMI [1]-[4] knob
- 4 [MAIN] fader

7. For each channel, select the weight level, then use the [VALUE] knob to set the priority of volume-level distribution (from 0 to 100).



While in a state where only ambient sound (background sound) is being input, adjust so that the Auto Mixing level meters for the respective channels (the meters on the right side) fluctuate evenly.

- If there is a channel that you want to make more prominent, such as when you want to raise the volume level of an emcee microphone, raise the weight level of the channel to emphasize and lower the weight level for other channels.

This completes the settings for Auto Mixing.

MEMO

- On channels for which Auto Mixing is set to "ON," setting the weight level to "0" results in no audio output.
- When air-conditioner noise or the like is a concern, set the weight level to a low value.

8. Press the [SYSTEM SETUP] button several times to quit the setup screen.

MEMO

- You can assign the Auto Mixing feature to a USER button and use the button to switch it on and off.
For information on how to use the USER buttons, refer to "Assigning Functions to USER Buttons" (p. 37).
- You can also switch the Auto Mixing feature on and off by using the [SYSTEM SETUP] button → <AUDIO> → making the setting for <AUTO MIXING SW>.

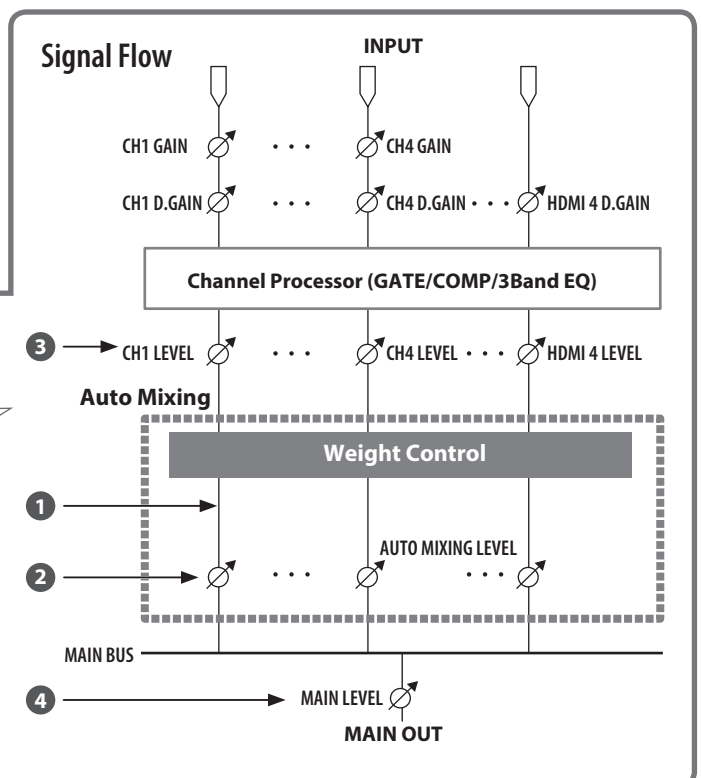

Using the AUX Bus

The VR-4HD has two built-in audio buses (a MAIN bus and an AUX bus). You can select the audio bus to output for each individual connector.

MAIN bus	This receives all input audio as a group and sends it to output (main output audio).
AUX bus	This lets you selectively choose and mix the input audio to send, and sends it to output. You can output different audio than the main output audio.

For example, you can use this at a live performance venue to output a mix of all input audio (MAIN bus), and when recording or streaming a broadcast, you can use this to output just certain specific input-audio streams (AUX bus).

MEMO

- Reverb (p. 29) is not applied to audio on the AUX bus.
- You can align the timing of AUX bus audio and video. For details, refer to “Aligning the Output Timing of Video and Audio (Lip-sync)” (p. 35).

Assigning an Audio Bus to Audio Output Connectors

1. Press the MAIN [SETUP] button to display the setup screen.
2. Select <BUS SELECT> to display the BUS SELECT screen.



3. Select the output connector whose audio-bus assignment you want to change.

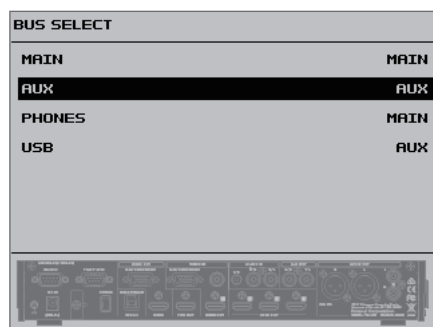

4. Use the [VALUE] knob to specify “MAIN” or “AUX.”

Value	Explanation
MAIN	MAIN bus audio is output.
AUX	AUX bus audio is output.

5. Press the MAIN [SETUP] button several times to quit the BUS SELECT screen.

Sending Audio to the AUX Bus

1. Press the [SETUP] button for the input audio you want to use on the AUX bus, making the setup screen appear.
2. Select <AUX SEND>.



3. Use the [VALUE] knob to adjust the send level for the audio to the AUX bus.
4. Press the [SETUP] button to quit the setup screen.

Adjusting the Volume Level of Output Audio on the AUX Bus

1. Press the MAIN [SETUP] button to display the setup screen.
2. Select <AUX LEVEL>.



3. Use the [VALUE] knob to adjust the volume level of AUX bus output audio.
4. Press the MAIN [SETUP] button to quit the setup screen.

Interlinking Audio Output to Video Switching (Audio Follow)

You can associate audio with a video switch so that when the video is switched, the specified audio alone is output automatically, and other audio is automatically muted.

NOTE

- When the Audio Follow feature is on, only the switching for output and muting is performed automatically. The positions of volume-adjusting faders and knobs do not change automatically.

- Follow the procedure in “Adjusting the Volume Level of Input Audio” (p. 26) to adjust to the volume level you want to output.
- Press the MAIN [SETUP] button to display the setup screen.
- Select <AUDIO FLW> to display the AUDIO FOLLOW screen.



- For each video channel, set the input audio to use with Audio Follow to “ON.”

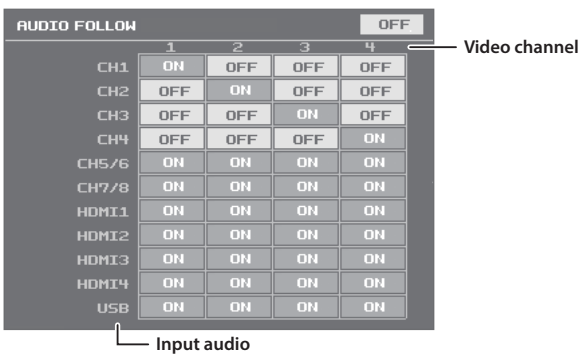

Value	Explanation
ON	Used by Audio Follow.
OFF	Not used by Audio Follow.

- Set the Audio Follow switch to “ON.”

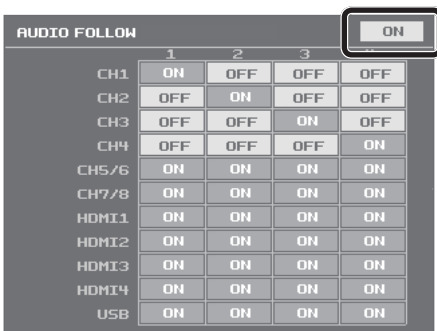

The Audio Follow feature is turned on.

- Press the [SYSTEM SETUP] button several times to quit the setup screen.

- Switch the video channel (p. 18).

When the video is switched, only the audio interlinked with it by Audio Follow in step 4 is output.

MEMO

- “FLW” is displayed in the <LEVEL> field on the respective setup screen for audio for which Audio Follow is switched on.



- You can assign the Audio Follow feature to a USER button and use the button to switch it on and off.

For information on how to use the USER buttons, refer to “Assigning Functions to USER Buttons” (p. 37).

Aligning the Output Timing of Video and Audio (Lip-sync)

Normally, because video processing takes more time than audio processing, the video is output later than the audio, resulting in video and audio that are out of sync.

On the VR-4HD, you can delay and output the audio input via the respective channels, HDMI, and USB. Delaying audio output lets you output video and audio at the same timing.

1. Input the audio and video from a video camera or other source.
2. Output the video to a projector or other display device and the audio to speakers or headphones.
3. Check whether the video and audio are out of sync.
For example, in a scene showing a drum performance, the sound of the drums being hit might be heard ahead of the video.
4. Press the [SETUP] button for the input audio whose output you want to delay, making the setup screen appear.
5. Select <DELAY>.



6. Use the [VALUE] knob to adjust the length of the delay for the audio.

Delay the audio until it is aligned with the video.

MEMO

- The amount of delay you apply to the audio depends on the entire system, including the projector.

7. Press the [SETUP] button to quit the setup screen.

MEMO

- You can adjust the delay time individually for USB output audio and AUX bus audio.
 - **USB Output Audio**
The USB [SETUP] button → at the USB TO PC page, adjust <DELAY>.
 - **AUX Bus Audio**
The MAIN [SETUP] button → adjust <AUX DELAY>.

Operations Using a Computer

Outputting Streaming-use Video/Audio to a Computer

You can connect a computer and output video and audio mixed on the VR-4HD to it. You can also input audio played back on the computer. Using an Internet-connected computer and transfer software makes possible Internet drive transmission.

NOTE

- For the video and audio signals from the VR-4HD to be viewed and heard correctly on the computer, software that supports USB video class and USB audio class must be installed and set up on the computer.

Supported Operating Systems

Windows	Mac
Windows 7 Service Pack 1 and after	Mac OS X 10.9 or later
Windows 8	
Windows 8.1	
Windows 10	

* Connection and operation of the VR-4HD with standard computers running the operating systems described above have been verified, but connection and operation with all computers satisfying such conditions is not assured. Connection or operation may be impossible due to differences in setting specifications or the usage environment that are specific to the equipment.

Making the Connection to a Computer

- Start the computer.
- Using a USB 3.0 cable, connect a USB 3.0 port on the computer to the USB 3.0 port on the VR-4HD (p. 8).
- Turn on the power to the VR-4HD (p. 10).

When communication with the computer is established, the VR-4HD is seen as a USB video device or USB audio device by the computer.

* When the VR-4HD has been connected to the computer for the first time, the operating system's standard driver is automatically installed.

Checking the Status of the USB Connection

- Press the USB [SETUP] button to display the setup screen.

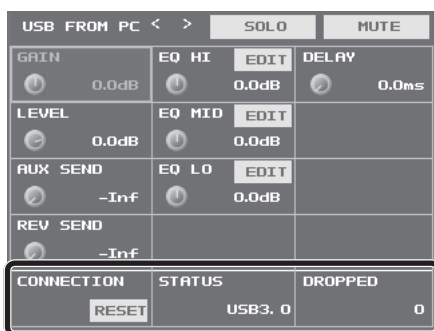

Item	Explanation
CONNECTION	If a USB connection with the computer fails to be established or video is corrupt, select <RESET> to reconnect via USB.
STATUS	This indicates a connection using either USB 2.0 or USB 3.0.
DROPPED	This is normally "0." An increase in this value means that video transmission is not fast enough.

- Press the USB [SETUP] button to quit the setup screen.

Outputting Video/Audio to the Computer

- Operate the VR-4HD to prepare the video or audio to Output to the computer.

- On the computer, confirm the input from the VR-4HD.

Start a program that supports USB video class or audio class, and check the video or audio input from the VR-4HD.

If necessary, make the following settings on the VR-4HD.

- Use the [TO PC] knob to adjust the volume level of USB output audio (p. 27).
- Adjust the volume balance of the input audio (p. 27).
- Adjust the volume level of the main output audio (p. 27).
- Align the output timing of the video and audio (p. 35).
For USB output audio only, you can delay output individually. The USB [SETUP] button → at the USB TO PC page, use <DELAY> to adjust the delay time for audio.
- Make the setting for the audio bus assigned to the USB 3.0 port (p. 33).
- Specify whether either of the following is set as the video output via USB (p. 16).
 - Main output video
 - Four-way split screen using input video (channels 1–4)

Using the Loopback Feature

You can take audio played back by a program on the computer, mix it with other audio input into the VR-4HD, and return the result back to the computer (Loopback feature).

This lets you do things like adding narration to played-back music, then using computer software to record or stream it.

Recording Video on a Computer

You can use the dedicated Video Capture for VR software to capture (record) video and audio output from the VR-4HD on a computer connected via USB.

For more information about operation methods, refer to the owner's manual included with Video Capture for VR.



Video Capture for VR can be downloaded from the following Roland website.

<https://proav.roland.com/>

Other Features

Assigning Functions to USER Buttons

You can assign functions to the USER [1] through [5] buttons. This lets you switch a function on and off or display a screen for accessing the function simply by pressing the USER button. By factory default, the functions appearing on the operation panel are assigned to the USER buttons.

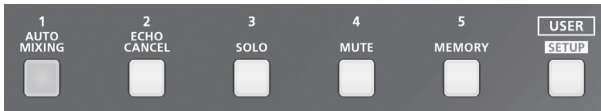

MEMO

- You can specify which color each USER button lights up in. Use the USER [SETUP] button → <ASSIGN> → the corresponding item among <USER1 LED COLOR> through <USERS5 LED COLOR> to make the setting.

Changing Function Assignments

- Press the USER [SETUP] button to display the setup screen.
- Select <ASSIGN> to display the ASSIGN menu.

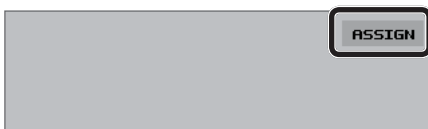

- Select from among <USER1 ASSIGN> through <USERS5 ASSIGN>.

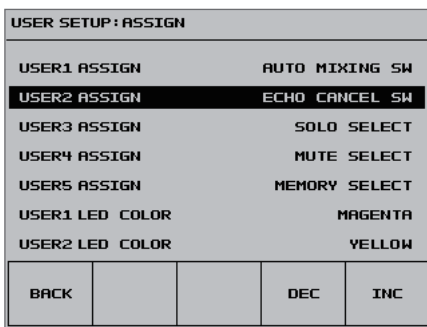

- Use the [VALUE] knob to specify the function assigned to the USER button.

For details, refer to the table below.

- Press the USER [SETUP] button several times to quit the setup screen.

Making Advanced Settings for Assigned Functions

- Press the USER [SETUP] button to display the setup screen.
- Select from among <USER1> through <USERS5> to display the corresponding USER1 through 5 SETUP screen.

The functions currently assigned to the on-screen buttons are displayed.

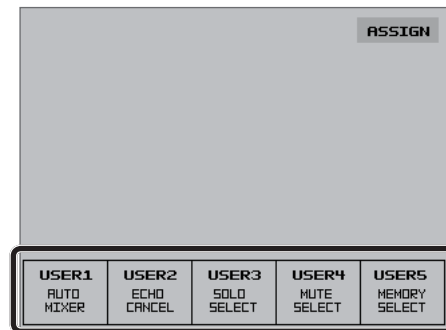

- Make advanced settings for the function.

For information on what can be set, refer to the table below.

- Press the USER [SETUP] button several times to quit the setup screen.

<USER1 ASSIGN>-<USERS5 ASSIGN> Settings		<USER1> - <USERS5> → USER1-USER5 SETUP Screen	Page to see
Value	Functions Assigned to the USER [1]-[5] Buttons	Making Advanced Settings for Assigned Functions	
NONE	— (No function is assigned.)	—	—
ECHO CANCEL SW	This switches the Echo Cancel feature on or off.	This specifies items on the ECHO CANCEL screen.	p. 31
AUTO MIXING SW	This switches the Auto Mixing feature on or off.	This specifies items on the AUTO MIXING screen.	p. 32
AUDIO FLW SW	This switches the Audio Follow feature on or off.	This specifies items on the AUDIO FOLLOW screen.	p. 34
AUTO SCAN SW	This switches the Auto Scan feature on or off.	This sets the interval for which video is displayed (AUTO SCAN TIME).	p. 19
MEMORY SELECT	This displays the MEMORY LOAD screen. This lets you select and call up a memory.	At the MEMORY SELECT setup screen, you can save settings to memory 1-8 and edit memory names.	p. 38
MEMORY LOAD	This calls up a saved memory.	The memory you want to call up is saved when you press the USER button.	
MUTE SELECT	This displays the MUTE SELECT screen. This lets you specify whether the Mute feature is on (red) or off for each individual audio input and output.	—	p. 30
MUTE GROUP	This switches the Mute feature on or off globally for all audio assigned to a group.	When you press the USER button, the input audio and output audio for which the Mute feature is to be switched on are selected and assigned to a group.	
SOLO SELECT	This displays the SOLO SELECT screen. This lets you specify whether the Solo feature is on (blue) or off for each individual audio input.	—	
SOLO GROUP	This switches the Solo feature on or off globally for all audio assigned to a group.	When you press the USER button, the input audio and output audio for which the Solo feature is to be switched on are selected and assigned to a group.	p. 41
GPO	This outputs a control signal from the TALLY/GPIO connector. The USER button lights up during output of the control signal.	This specifies the GPO channel (1-4) on which the control signal is output and the operation modes of the respective GPO channels.	

* Pressing a USER button to switch on (activate) its assigned function makes the USER button light up.

Saving/Recalling Settings (Memory)

You can take the current settings, including video and audio settings and the state of the operation panel, and save them as a single set in memory, for later recall and use when needed. The VR-4HD is provided with eight memories.

Saving a Memory

1. Press the [SYSTEM SETUP] button to display the setup screen.
2. Select <MEMORY> to display the MEMORY menu.
3. Select <SAVE> to display the MEMORY SELECT screen.

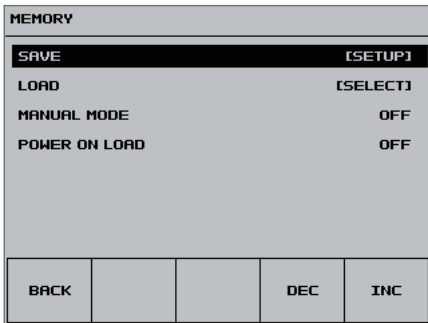

4. Select the memory where you want to save the settings.

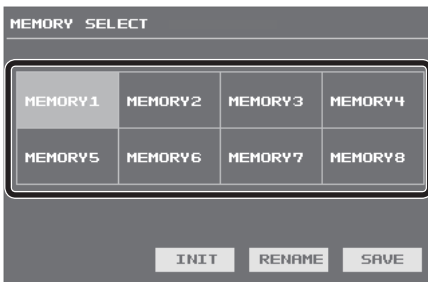

5. Select <SAVE>.

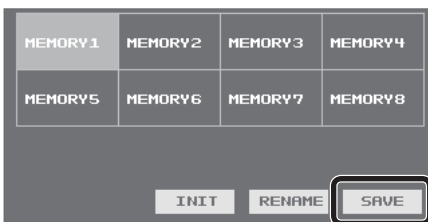

6. Check the message, then select <OK>.
(If you want to quit, select <CANCEL>.)

The current settings are saved.

7. Press the [SYSTEM SETUP] button several times to quit the setup screen.

MEMO

- The state of the [OUTPUT FADE] button on the operation panel is not saved in memory.
The following settings are also not saved in memory. Only a single set is saved in the unit.

Setup screen for the system ([SYSTEM SETUP] Button)	
Category	Setting items saved in the unit
SYSTEM	All setting items except "COLOR BAR OUTPUT" and "TEST TONE OUTPUT"
REMOTE	All setting items
MEMORY	

* "COLOR BAR OUTPUT" and "TEST TONE OUTPUT" are always set to "OFF" at startup.

Changing the Name of a Memory

You can change the name of a memory.

1. At the MEMORY SELECT screen, select the memory whose name you want to change.
2. Select <RENAME> to display the RENAME MEMORY screen.

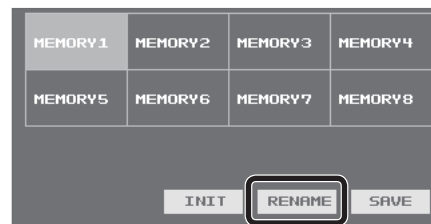

3. Use the software keyboard to select keys and change the name of the memory.



You can enter a text string of up to 8 characters in length.

The characters are entered in order from the beginning. Using the <Bs> key deletes the last character.

4. Select <SET>.
(If you want to cancel the operation, select <CANCEL>.)
The name of the memory is changed.

Initializing Memory Settings

You can initialize the values of settings in individual memories, returning the setting to their factory defaults.

1. At the MEMORY SELECT screen, select the memory you want to initialize.
2. Select <INIT>.



3. Check the message, then select <OK>.
(If you want to quit, select <CANCEL>.)

Initialization is executed.

Recalling a Memory

1. Press the [SYSTEM SETUP] button to display the setup screen.
2. Select <MEMORY> to display the MEMORY menu.
3. Select <LOAD> to display the MEMORY LOAD screen.

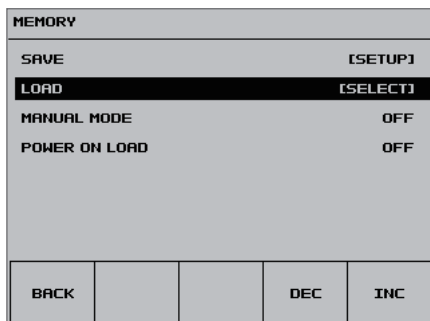

4. Select the memory you want to call up.

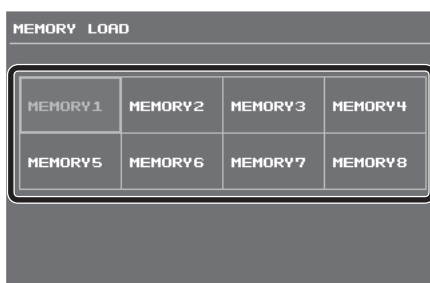

The settings are recalled.

NOTE

Screen corruption occurs when settings are recalled

When settings in memory are recalled, corruption of the output video occurs when the input connectors are switched or the output format changes.

5. Press the [SYSTEM SETUP] button several times to quit the setup screen.

MEMO

- You can maintain the current positions of controls without overwriting them when settings are recalled from memory. Use the [SYSTEM SETUP] button → <MEMORY> → <MANUAL MODE> to set the value to "ON."
- You can also recall settings from a specified memory number at startup. Use the [SYSTEM SETUP] button → <MEMORY> → <POWER ON LOAD> to specify the memory number whose settings you want to recall.
- You can assign a memory function to a USER button to call up and use the memory.

For information on how to use the USER buttons, refer to "Assigning Functions to USER Buttons" (p. 37).

Preventing Unintended Operation (Panel Lock)

You can lock the operation of buttons and knobs to prevent inadvertent operation of the VR-4HD.

1. Press the [SYSTEM SETUP] button to display the setup screen.
2. Select <SYSTEM> to display the SYSTEM menu.
3. Select <PANEL LOCK>, <MONITOR BUTTON LOCK>, or <TOUCH PANEL LOCK> as the type of panel lock to use.

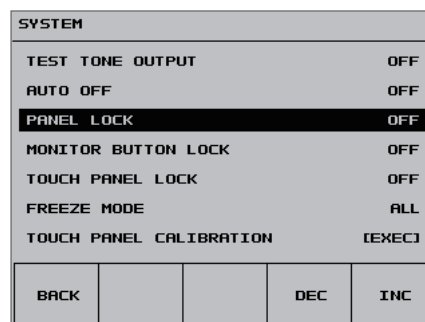

Setting item	Target of panel lock
PANEL LOCK	All controls except the following <ul style="list-style-type: none"> • [SYSTEM SETUP] button • [VALUE] knob
MONITOR BUTTON LOCK	[INPUT] [OUTPUT] buttons
TOUCH PANEL LOCK	Tap operations on the built-in monitor

4. Use the [VALUE] knob to set panel lock to enabled (ON) or disabled (OFF).
5. Press the [SYSTEM SETUP] button several times to quit the setup screen.

Turning Off the Power Automatically (Auto Off)

Auto Off is a feature that automatically turns off the power after no operation for a specific period of time. This helps prevent wasting electrical power.

By factory default, the Auto Off function is set on. When the states described below persist for 240 minutes, the Auto Off function acts to automatically turn off the power.

- No operation performed on the VR-4HD
- No audio or video input

To turn the Auto Off function off or on, follow the steps below to change the setting.

MEMO

- When the power has been turned off by the Auto Off function, to restart, first press the [POWER] button to return it, then turn on the power.

1. Press the [SYSTEM SETUP] button to display the setup screen.
2. Select <SYSTEM> to display the SYSTEM menu.
3. Select <AUTO OFF>.

SYSTEM	
TEST TONE OUTPUT	OFF
AUTO OFF	OFF
PANEL LOCK	OFF
MONITOR BUTTON LOCK	OFF
TOUCH PANEL LOCK	OFF
FREEZE MODE	ALL
TOUCH PANEL CALIBRATION	[EXEC]
BACK	DEC INC

4. Use the [VALUE] knob to set the Auto Off function on or off.

Value	Explanation
ON	The Auto Off function is turned on. Power is turned off automatically.
OFF	The Auto Off function is turned off. Power is not turned off automatically.

6. Press the [SYSTEM SETUP] button several times to quit the setup screen.

Returning Settings to the Factory-default State (Factory Reset)

You can return the values of settings on the VR-4HD to their factory defaults.

If operation that differs from what is described in the owner's manual occurs even when the steps described are followed correctly, try performing a factory reset.

NOTE

- Performing a factory reset causes all settings made and values saved in memory (p. 38) to be lost.

1. Press the [SYSTEM SETUP] button to display the setup screen.
2. Select <SYSTEM> to display the SYSTEM menu.
3. Select <FACTORY RESET>.

SYSTEM	
FACTORY RESET	[EXEC]
VERSION	1.000
BACK	DEC INC

4. Check the message and select <OK>.
(If you want to quit, select <CANCEL>.)

A factory reset is executed.

5. Press the [SYSTEM SETUP] button several times to quit the setup screen.

Operating the VR-4HD by Remote Control

You can operate the VR-4HD remotely from an external device.

Using the Dedicated VR-4HD RCS Program

You can use VR-4HD RCS dedicated software to remotely control the following functions on the VR-4HD from a computer connected via USB.

For more information about operation methods, refer to the owner's manual included with VR-4HD RCS.

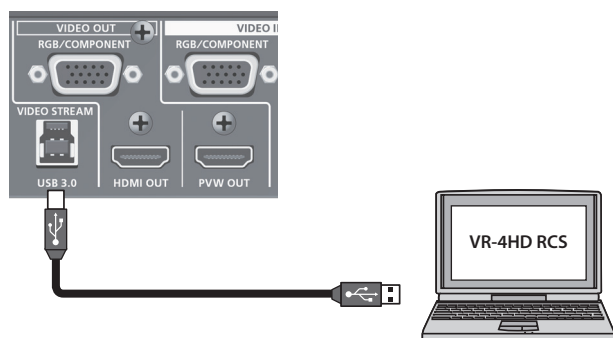

VR-4HD RCS can be downloaded from the following Roland website.
<https://proav.roland.com/>

Using RS-232, GPI, or MIDI

You can operate the VR-4HD remotely from an external device by means of RS-232, GPI, or MIDI (via USB).

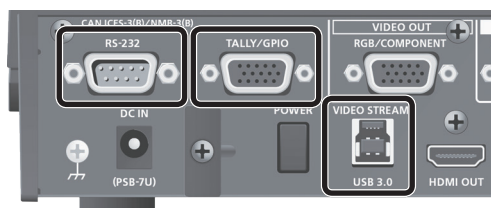

* The TALLY/GPIO connector also supports control-signal and tally-signal output.

For more information on the specifications of the RS-232 connector and TALLY/GPIO connector and how to operate the unit remotely, refer to the Reference Manual (PDF) available for download at the Roland website.

<https://proav.roland.com/>

Outputting a Tally Signal or Control Signal

You can output a tally signal or a GPO control signal from the TALLY/GPIO connector.

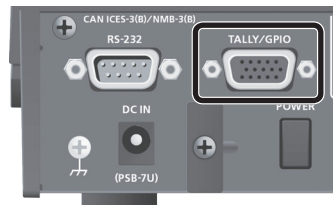

Tally

A tally signal is output from the connector pin corresponding to the video channel being output, also including video composition and transition effects.

* The tally-signal output is for the main output video.

GPO

A control signal is output by assigning a GPO channel (1 through 4) to a USER button, then operating the USER button.

For each respective GPO channel, you can specify "ONE SHOT" (1-second output of the control signal) or "ALT" (alternate output of the control signal).

For more information on the specifications and usage of the TALLY/GPIO connector, refer to the Reference Manual (PDF) available for download at the Roland website.

<https://proav.roland.com/>

Calibrating the Tap Points on the Touch Panel

The detected location on the screen when tapped might become misaligned with the location actually tapped. If this happens, calibrating the tap points can improve tapping accuracy (touch panel calibration).

1. Press the [SYSTEM SETUP] button to display the setup screen.
2. Select <SYSTEM> to display the SYSTEM menu.
3. Select <TOUCH PANEL CALIBRATION>.

SYSTEM	
TEST TONE OUTPUT	OFF
AUTO OFF	OFF
PANEL LOCK	OFF
MONITOR BUTTON LOCK	OFF
TOUCH PANEL LOCK	OFF
FREEZE MODE	ALL
TOUCH PANEL CALIBRATION	[EXEC]

BACK			DEC	INC
------	--	--	-----	-----

4. Working in sequence from the top left, tap the crosshair cursor inside the red border.



When you have tapped the four crosshair cursors and all four have turned red, calibration is complete.

5. To apply the results of calibration, press the [VALUE] knob. (To quit without applying, press the [SYSTEM SETUP] button.)
6. Press the [SYSTEM SETUP] button several times to quit the setup screen.

Appendices

Troubleshooting

If you suspect a malfunction, please check the following points. If this does not resolve the problem, contact a nearby Roland Service Center.

Problem	Items to check	Action	Page
Video-related problems			
No picture is input.	Is the system format set correctly?	Video in a format that differs from the setting on the VR-4HD is being input. Set the system format to match the connected device.	p. 13
	Has the video source been correctly assigned to channel 4?	Specify the video source to assign to channel 4.	p. 15
	Is copyright-protected (HDCP) video being input?	When inputting copyright-protected (HDCP) video signals, go to the SETUP menu and set "HDCP" to "ON."	p. 17
Video from the computer is not displayed.	Is the format of the video output from the computer compatible with the VR-4HD's input formats?	The supported input formats on channels 1 through 3 are 1080p, 1080i, and 720p. Only channel 4 supports VESA-standard resolutions.	p. 13 p. 14
Video from the computer is corrupted.	When a rapidly moving video is input from a computer, out-of-sync motion, flicker, or other picture corruption may occur.	This is called "tearing," and does not indicate an equipment malfunction.	—
No picture is output.	Is "HDCP" set to "ON"?	When "HDCP" is set to "ON," video is output only from the HDMI OUT and PVW OUT connectors. No video is output via the RGB/COMPONENT connector and USB 3.0 port.	p. 17
	Is the [OUTPUT FADE] button lighted?	When the [OUTPUT FADE] knob is lighted, a fade is applied to the main output video. To output the video, press the [OUTPUT FADE] button to make it go dark.	p. 19
	Is the monitor connected correctly?	When outputting copyright-protected (HDCP) video, connect an HDCP-compatible display.	p. 17
	Does the color-space setting on the VR-4HD match the output device (external display, projector, or the like)?	Use "OUTPUT COLOR SPACE" or "PREVIEW COLOR SPACE" to change the color-space setting.	p. 15
No connection can be made using USB 3.0, or the picture is jerky.	Is the connection using an extension cable or USB hub?	Making the connection using an extension cable or USB hub might result in the computer failing to recognize the VR-4HD. We recommend using a direct connection between the VR-4HD and the computer.	—
	—	Go to the setup screen for USB and select <RESET>, then redo the USB connection.	p. 36
	Is a USB 2.0 cable being used to connect the VR-4HD and the computer?	When outputting video via USB, use a USB 3.0 cable to connect the USB 3.0 port on the VR-4HD to a USB 3.0 port on the computer.	—
"Snowy"-noise video is output.	It is possible that the HDMI signal is not being sent and received correctly.	Reconnect the HDMI cable.	—
Video cannot be switched by tapping the screen.	Is the setup screen displayed?	The touch screen cannot be used for switching video while the setup screen is displayed. Exit the setup screen.	—
Colors are incorrect.	Does the color-space setting on the VR-4HD match the output device (external display, projector, or the like)?	Use "OUTPUT COLOR SPACE" or "PREVIEW COLOR SPACE" to change the color-space setting.	p. 15
HDMI output shown on a display has its periphery cut off.	Are the display settings compatible?	In the case of HDMI signals, automatic overscan occurs on some displays. Change the display's settings.	—
Compositing a logo or video cannot be accomplished.	Have the correct key type and extraction color for key composition been selected?	Select a key type and extraction color that match the logo or video background color.	p. 24
Audio-related Problems			
No audio is output. Audio volume is low.	Is the volume turned down on the VR-4HD?	Adjust each input-audio stream to an appropriate volume level. Also, use the [MAIN] fader to adjust the overall volume level.	p. 26 p. 27
	Is the volume of USB output audio turned down?	Turn the [TO PC] knob to adjust to an appropriate volume level.	p. 27
	Is there input audio for which the Solo feature is turned on?	When Solo is set for an input-audio stream, only the input audio for which Solo has been turned on is heard through headphones. Turn off the Solo feature.	p. 30
	Has the input gain of audio been turned down?	When input gain is turned down, no audio is output even when the volume level is raised. Adjust the input gain.	p. 26
	Is a condenser microphone connected?	When connecting a condenser microphone or other device requiring phantom power, set the [PHANTOM] switch to "ON."	p. 9
No reverb is applied when the [REVERB] knob is turned.	Is the amount of audio sent to Reverb set at an appropriate level?	If the send level for audio to Reverb is too low, the amount of reverb effect might be difficult to discern. Adjust the send level of the audio to Reverb.	p. 29
Other Problems			
When the screen is tapped, the responsive location is different from the place tapped.	Due to the characteristics of the touch panel, the detected location on the screen when tapped can become misaligned with the location actually tapped, but this does not indicate a malfunction.	Perform calibration of the tap points.	p. 42
Nothing happens when tapped. Buttons and knobs cannot be operated.	Is panel lock enabled?	Set "PANEL LOCK," "MONITOR BUTTON LOCK," and "TOUCH PANEL LOCK" to disabled (OFF).	p. 39

Block Diagram

Video

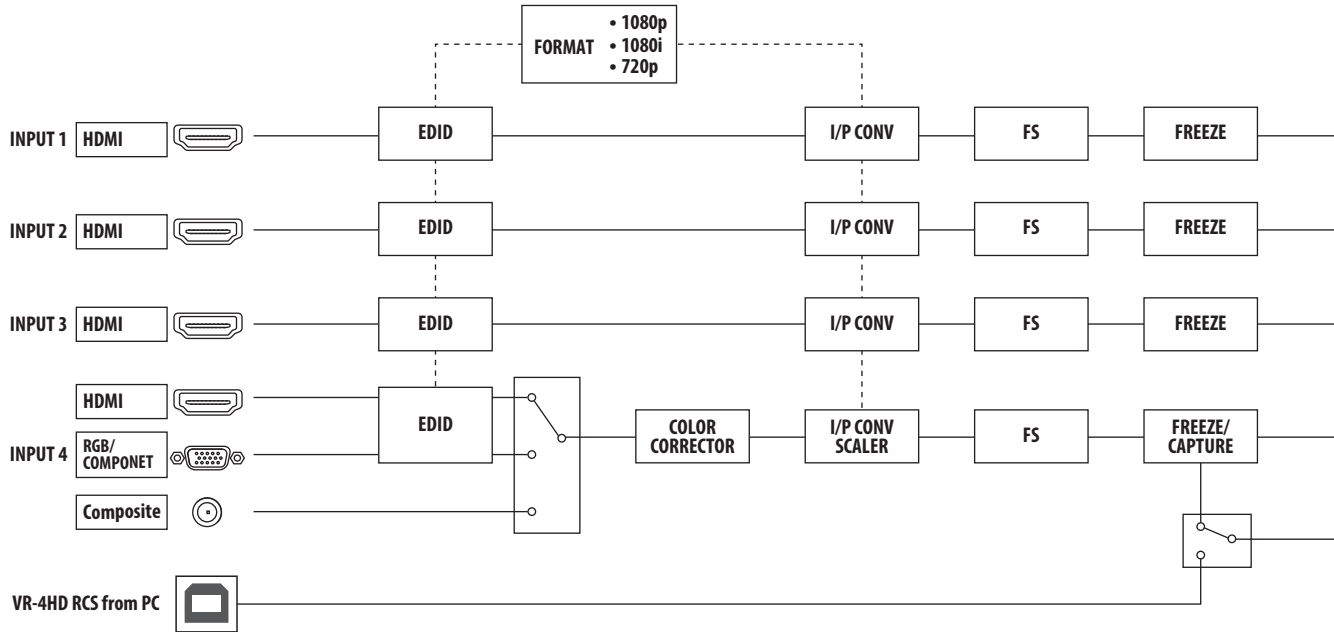

Audio

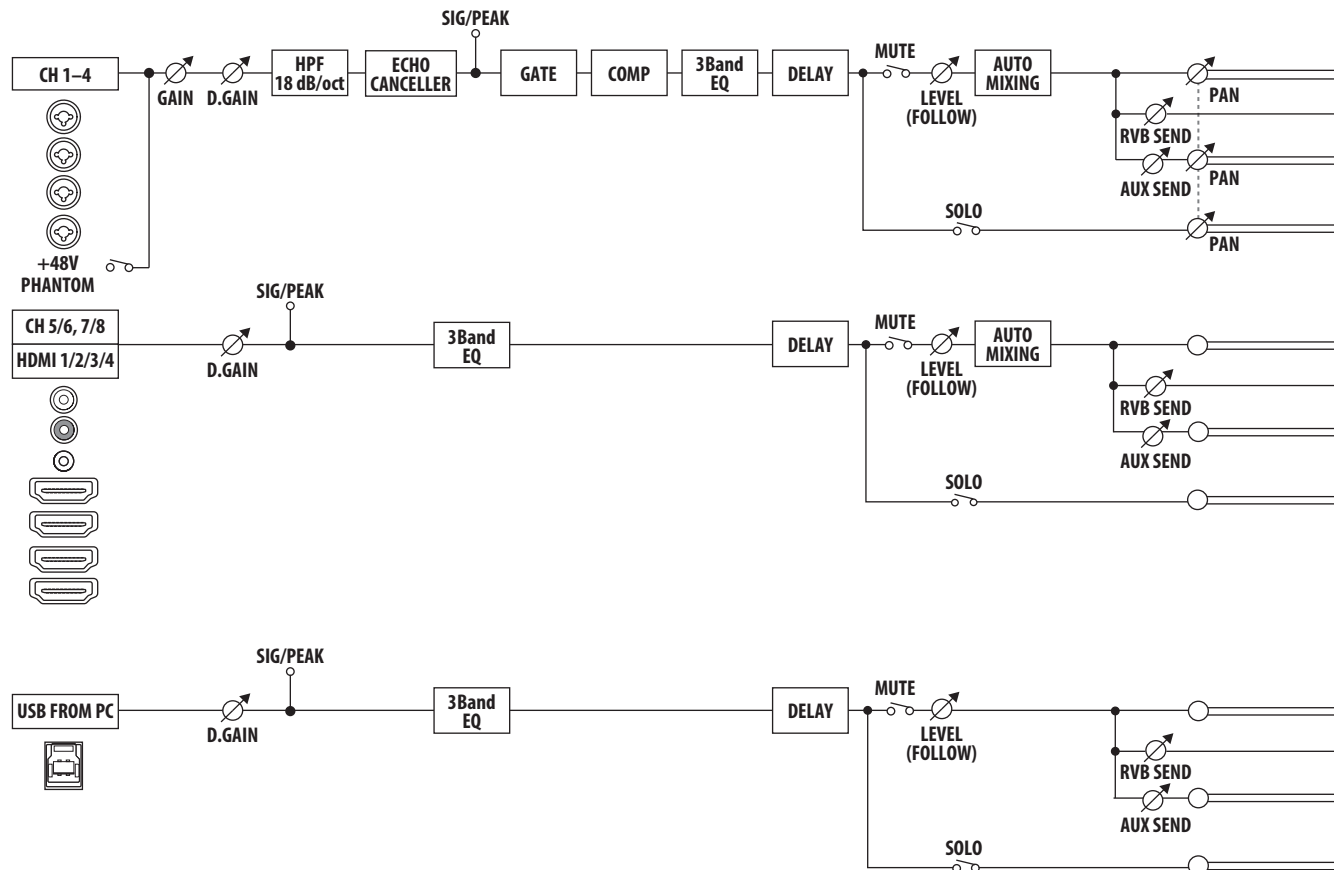

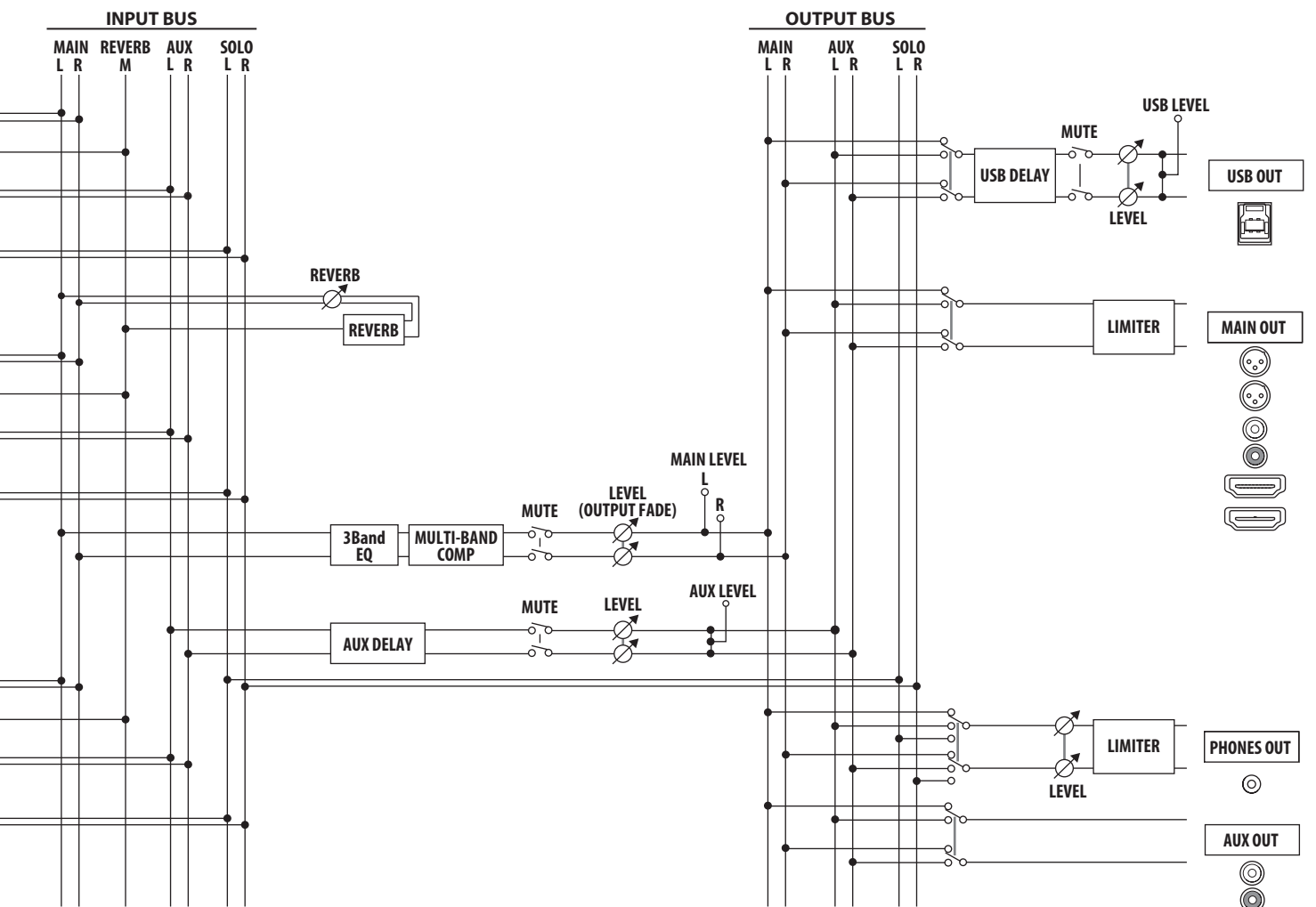
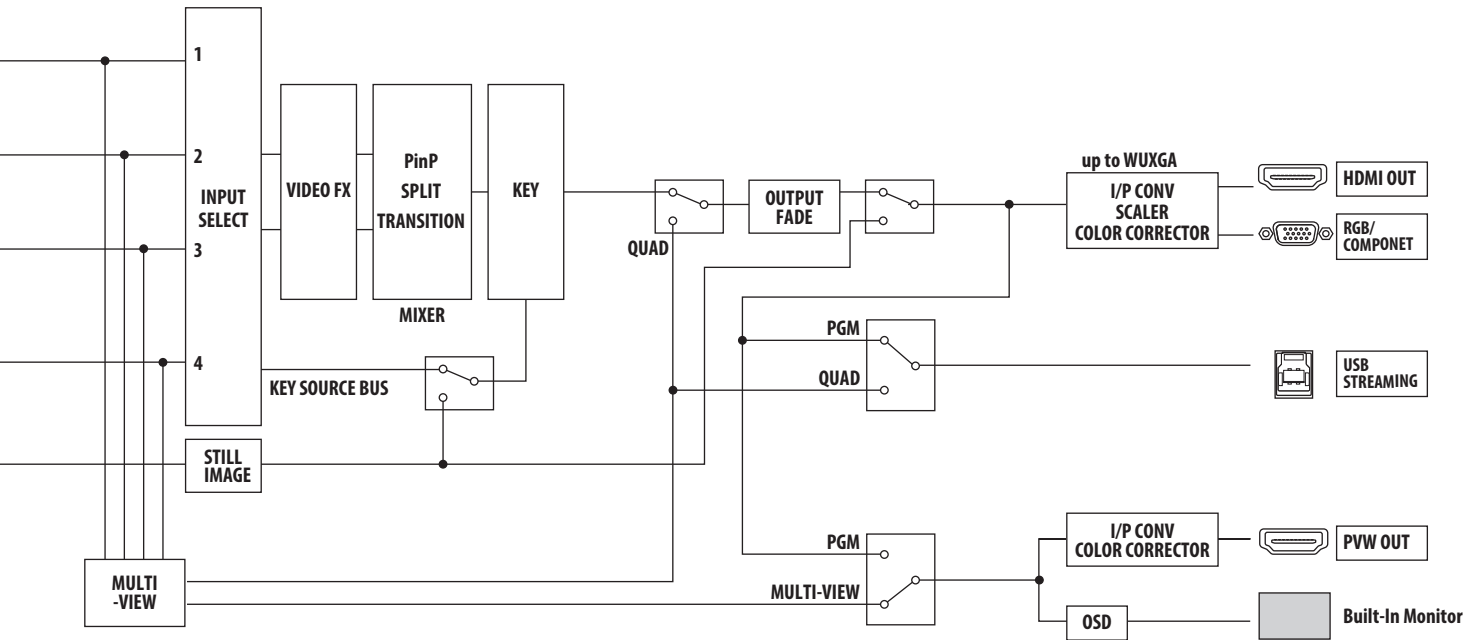

Main Specifications

Roland VR-4HD: HD AV Mixer

Video

Video Processing	4:2:2 (Y/Pb/Pr), 8-bit	
Input Connectors	INPUT 1–3	
	HDMI Type A (19 pins) x 3 * HDCP Supported	
	HDMI Type A (19 pins) x 1 * HDCP Supported	
	INPUT 4	RGB/COMPONENT (Mini D-sub 15-pin type) x 1 COMPOSITE (RCA phono type) x 1 * INPUT 4: HDMI, RGB/COMPONENT or COMPOSITE selected.
Output Connectors	MAIN OUT	
	HDMI Type A (19 pins) x 1 * HDCP Supported	
	RGB/COMPONENT (Mini D-sub 15-pin type) x 1	
	PREVIEW OUT	
HDMI Type A (19 pins) x 1 * HDCP Supported		
USB 3.0		USB B type x 1
Input formats^{*1*2}	HDMI INPUT 1–3	
	720/59.94p, 720/50p (SYSTEM FORMAT: 720p) 1080/59.94i, 1080/50i, 1080/59.94p, 1080/50p (SYSTEM FORMAT: 1080i, 1080p)	
	INPUT 4	HDMI RGB/COMPONENT
	480/59.94i, 576/50i, 480/59.94p, 576/50p, 720/59.94p, 720/50p, 1080/59.94i, 1080/50i, 1080/59.94p, 1080/50p VGA (640 x 480/60 Hz), SVGA (800 x 600/60 Hz), XGA (1024 x 768/60 Hz), WXGA (1280 x 768/60 Hz), SXGA (1280 x 1024/60 Hz), FWXGA (1366 x 768/60 Hz), SXGA+ (1400 x 1050/60 Hz), UXGA (1600 x 1200/60 Hz), WUXGA (1920 x 1200/60 Hz) * The refresh rate is the maximum value of each resolution. * Conforms to VESA DMT Version 1.0 Revision 11. * 1920 x 1200/60 Hz: Reduced blanking	
COMPOSITE		480/59.94i, 576/50i
Output formats^{*2}	MAIN OUT (HDMI, RGB/COMPONENT)	
	480/59.94i, 576/50i, 480/59.94p, 576/50p, 720/59.94p, 720/50p, 1080/59.94i, 1080/50i, 1080/59.94p, 1080/50p VGA (640 x 480/60 Hz), SVGA (800 x 600/60 Hz), XGA (1024 x 768/60 Hz), WXGA (1280 x 768/60 Hz), SXGA (1280 x 1024/60 Hz), FWXGA (1366 x 768/60 Hz), SXGA+ (1400 x 1050/60 Hz), UXGA (1600 x 1200/60 Hz), WUXGA (1920 x 1200/60 Hz) * The MAIN OUTPUT format of HDMI and RGB/COMPONENT is always the same.	
	PREVIEW OUT	720/59.94p, 720/50p (SYSTEM FORMAT: 720p) 1080/59.94i, 1080/50i (SYSTEM FORMAT: 1080i) 1080/59.94p, 1080/50p (SYSTEM FORMAT: 1080p)
	USB 3.0	720/29.97p, 720/25p (SYSTEM FORMAT: 720p) 1080/29.97p, 1080/25p (SYSTEM FORMAT: 1080i, 1080p)
Video Effects	Transition	CUT, MIX (DISSOLVE/FAM/NAM/MOSAIC), WIPE (30 types)
	Effects	NEGATIVE, EMBOSS, COLORIZE, COLORPASS, POSTERIZE, SILHOUETTE, MONOCOLOR, FINDEDGE (8 types)
	Composition	PinP, SPLIT, QUAD, KEY (Luminance Key, Chroma Key)

*1: The input interlaced video signal is converted to progressive video signal by internal processing.

*2: The video signal frame rate can be selected at the SYSTEM menu (59.94 Hz or 50 Hz).

Audio

Audio Processing	Sampling rate	24 bits/48 kHz	
Audio formats	HDMI	Linear PCM, 24 bits/48 kHz, 2 ch	
	USB	Linear PCM, 16 bits/48 kHz, 2 ch	
Input Connectors	AUDIO IN 1–4	XLR/TRS combo type, phantom power	
	AUDIO IN 5–6	RCA phono type	
	AUDIO IN 7/8	Stereo miniature type	
	USB	USB B type (stereo)	
	Phantom Power	DC 48 V (unloaded maximum), 10 mA (maximum load) * Current value per channel	
Output Connectors	AUDIO OUT	L, R (XLR type) L, R (RCA phono type)	
	AUX OUT	L, R (RCA phono type)	
	USB	USB B type (stereo)	
	PHONES	Stereo miniature type	
Signal Level and Impedance	XLR/TRS combo type	Input Signal Level	-60/+4 dBu (Maximum: +22 dBu)
		Input Impedance	10 k ohms (GAIN 0–23 dB), 5 k ohms (GAIN 24–64 dB)
	RCA phono type	Input Signal Level	-10 dBu (Maximum: +8 dBu)
		Input Impedance	15 k ohms
		Output Signal Level	-10 dBu (Maximum: +8 dBu)
		Output Impedance	1 k ohm
	XLR type	Output Signal Level	+4 dBu (Maximum: +22 dBu)
		Output Impedance	600 ohms
	Miniature type	Input Signal Level	-15 dBu (Maximum: +3 dBu)
		Input Impedance	15 k ohms
Headphones	Output Signal Level	75 mW + 75 mW	
	Output Impedance	32 ohms	
Audio Effects	Auto Mixing, Echo Cancel, EQ, Delay, Compressor, HPF, Gate, Reverb, Multi-Band Compressor, Limiter		

■ Other Connectors

RS-232	D-sub 9-pin type
Tally/GPIO	Mini D-sub 15-pin type
USB 3.0 (device)	USB B type, USB-VIDEO (USB3.0), USB-AUDIO 2 IN/2 OUT (USB2.0), remote control from PC

■ Display

Graphic Color LCD, 320 x 240 dots, touch panel

■ Other Functions

MEMORY (8 types), FREEZE (input video captured), OUTPUT FADE (Audio, Video: WHITE or BLACK), INPUT CAPTURE

■ Other

Power Supply	AC Adaptor	Dimensions	339 (W) x 217 (D) x 87 (H) mm 13-3/8 (W) x 8-9/16 (D) x 3-7/16 (H) inches
Current Draw	3 A	Weight (excluding AC adaptor)	2.4 kg 5 lbs 5 oz
Power Consumption	36 W	Accessories	Owner's manual, AC adaptor, Power cord
Operation Temperature	+0 to +40 degrees Celsius +32 to +104 degrees Fahrenheit		

* 0 dBu=0.775 Vrms

* This document explains the specifications of the product at the time that the document was issued. For the latest information, refer to the Roland website.

Dimensions

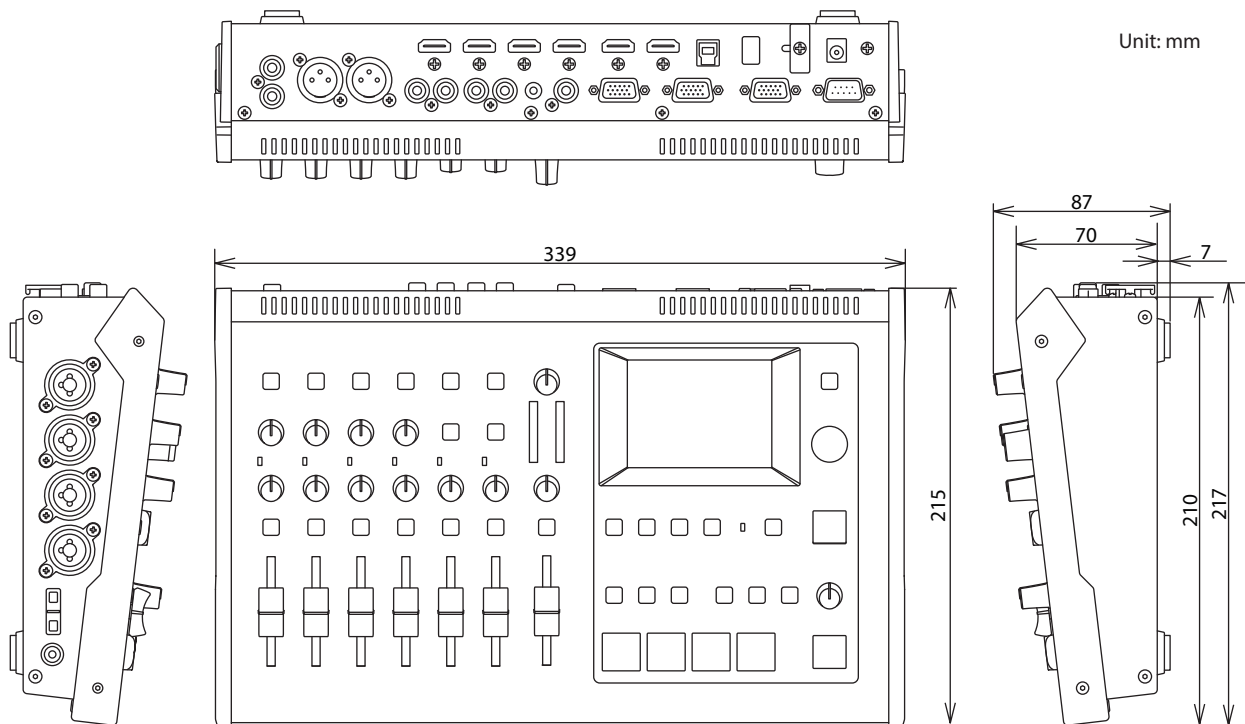

Transition Effects List

MIX



Effect	Explanation
MIX	The two pictures are blended together as the video is switched.
FAM	Video transitions are made with the luminance levels of the two video streams maintained unchanged. * This is an abbreviation of "full additive mix."
NAM	The two video streams are compared, and transitions are made with display during transition starting with levels of high luminance. * This is an abbreviation of "non-additive mix."
MOSAIC	Transitions are made with mosaic pixelation.

WIPE

The original video is broken into by the next video.

Normal

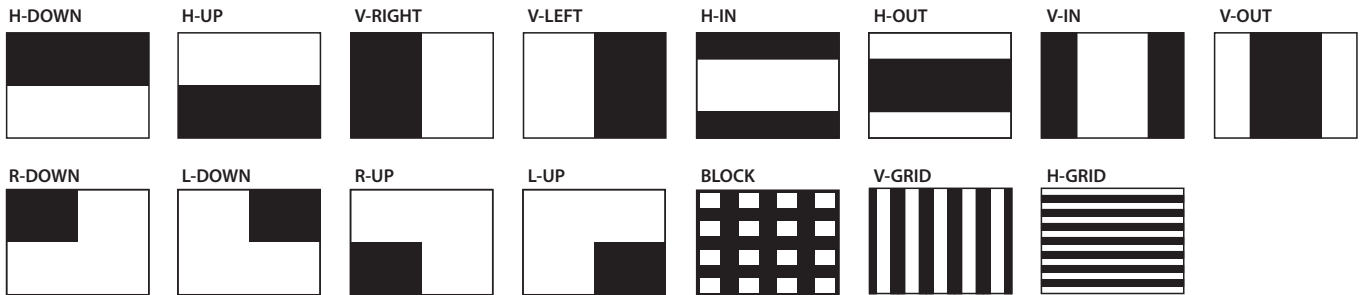

Soft Edge

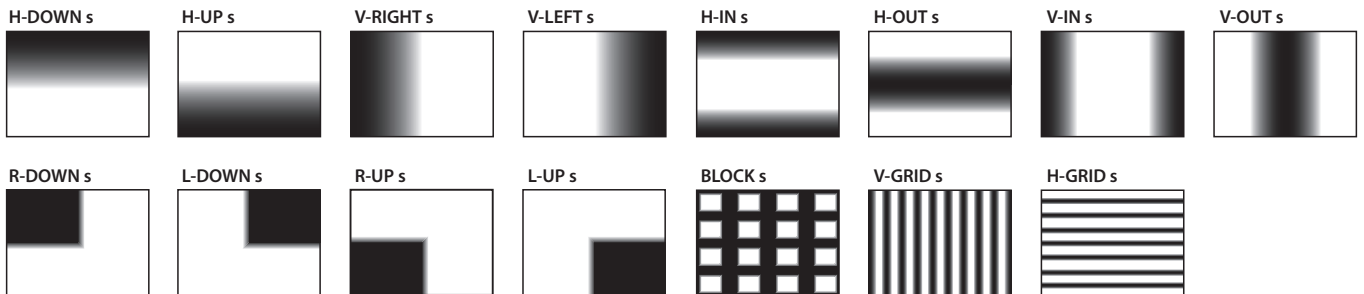

Index

A		D		I	
A-CENTER.....	23	DEINTERLACE MODE.....	13	Indicator.....	17, 26
ASSIGN.....	37	DELAY.....	35	[IN/OUT SETUP] button.....	11, 15, 16
ATTACK.....	28	Digital gain.....	26	[INPUT] button.....	10
Audio bus.....	33	DROPPED.....	36	INPUT CAPTURE.....	20
AUDIO FLW.....	34	E		INPUT CH LABEL DISPLAY.....	10
AUDIO FOLLOW.....	34	Echo cancel.....	31	Input formats.....	12, 13, 14
Audio format.....	12	ECHO CANCEL SETUP.....	31	Input gain (sensitivity).....	26
AUTO GAIN.....	28	EFFECT PATTERN.....	21	Input mode.....	10
Auto makeup gain.....	28	Effects (audio).....	28, 29	Inset screen.....	22
Auto mixing.....	32	Effects (video).....	21, 22, 23, 24	Interlinking (Audio follow).....	34
AUTO MIXING SETUP.....	32	EQ.....	28, 29	K	
AUTO OFF.....	40	EQ HI.....	28, 29	[KEY] button.....	25
AUTO SCAN.....	19	EQ LO.....	28, 29	Key composition.....	24
AUTO SCAN TIME.....	19	EQ MID.....	28, 29	KEY icon.....	25
AUX bus.....	33	Equalizer.....	28, 29	KEY LEVEL.....	25
AUX DELAY.....	35	F		KEY SOURCE CH.....	25
AUX LEVEL.....	33	Factory-default state.....	40	KEY TYPE.....	24
AUX MUTE.....	30	FACTORY RESET.....	40	L	
AUX SEND.....	33	Fade-in.....	19	LCD BRIGHTNESS.....	10
B		Fade-out.....	19	Level meter.....	10, 26, 27, 32
B-CENTER.....	23	Fader.....	27	LEVEL METER DISPLAY.....	10
BOB.....	13	Filter effects.....	21	LIMITER.....	29
BORDER COLOR.....	22	FLICK FILTER.....	16	Lip-sync.....	35
BORDER WIDTH.....	22	FLW.....	34	LOAD.....	39
BRIGHTNESS.....	16	Formats.....	12, 13, 14	Lock.....	39
Bus.....	33	FRAME RATE.....	13	Loopback.....	36
BUS SELECT.....	33	[FREEZE] button.....	20	LO RATIO.....	29
C		FREEZE MODE.....	20	LO THRES.....	29
Calibration.....	42	Freezing.....	20	LUMI KEY COLOR.....	24
Capturing (recording).....	36	FREQ.....	28, 29	LUMI KEY GAIN.....	25
Capturing (still image).....	20	[FROM PC] knob.....	27	LUMI KEY LEVEL.....	25
CH1 –CH4 DEPTH.....	31	G		Luminance key.....	24
CH1 –CH4 SW.....	31	Gain.....	26	M	
Channel fader.....	27	[GAIN] knob.....	26	MAIN bus.....	33
Chroma key.....	24	GATE.....	28	[MAIN] fader.....	27
CHROMA KEY COLOR.....	24	GPI.....	41	MAIN LIMITER.....	29
CHROMA KEY GAIN.....	25	GPO.....	41	MAIN MUTE.....	30
CHROMA KEY HUE FINE.....	25	H		Main output video.....	15
CHROMA KEY HUE WIDTH.....	25	HDCP.....	17	MAKEUP GAIN.....	28
CHROMA KEY LEVEL.....	25	HDCP indicator.....	17	MANUAL MODE.....	39
CHROMA KEY SAT FINE.....	25	HDMI knobs.....	27	MB COMP.....	29
CHROMA KEY SAT WIDTH.....	25	Head amp gain.....	26	Memory.....	38, 39
COLOR BAR OUTPUT.....	15	High-pass filter.....	28	MEMORY LOAD.....	39
Color space.....	15	HI RATIO.....	29	MEMORY SELECT.....	38
COMP.....	28	HI THRES.....	29	Menu.....	11
Compositing effects.....	22, 23, 24	HPF.....	28	MENU DISPLAY LEVEL.....	11
Composition patterns (Split).....	23	H. POSITION.....	16, 22	MIDI.....	41
Compressor.....	28	H. SIZE.....	16	MID RATIO.....	29
Computer (supported OS).....	36	I		MID THRES.....	29
CONNECTION.....	36	J		Mix.....	18
CONTRAST.....	16	K		[MIX] button.....	18
Copyright-protection (HDCP).....	17	L		MIX PATTERN.....	18
Cut.....	18	M		Mode (monitor view mode).....	10
[CUT] button.....	18	N		MONITOR BUTTON LOCK.....	39
D		O		Multi-band compressor.....	29
E		P		MUTE.....	30
F		Q		MUTE CLEAR.....	30
G		R		S	
H		T		U	
I		V		W	
J		X		Z	
K		Y		Other	
L		Other		Index	

O

OS (supported OS) 36
 OUTPUT BRIGHTNESS 15
 [OUTPUT] button 10
 OUTPUT COLOR SPACE 15
 OUTPUT CONTRAST 15
 OUTPUT DVI-D/HDMI 15
 OUTPUT FADE 19
 OUTPUT FADE BLACK LEVEL 19
 [OUTPUT FADE] button 19
 OUTPUT FADE WHITE LEVEL 19
 Output formats 12, 13, 14
 OUTPUT H. POSITION 15
 OUTPUT H. SIZE 15
 Output mode 10
 OUTPUT RESOLUTION 14
 OUTPUT SATURATION 15
 OUTPUT V. POSITION 15
 OUTPUT V. SIZE 15

P

PAN 27
 PANEL LOCK 39
 PATTERN 23
 Patterns
 Split composition 23
 Transition effects 48
 Phantom power 9
 [PHANTOM] switch 9
 PHONES LIMITER 29
 Picture-in-picture 22
 PinP 22
 [PinP] button 22
 POWER ON LOAD 39
 PREVIEW BRIGHTNESS 15
 PREVIEW COLOR SPACE 15
 PREVIEW CONTRAST 15
 PREVIEW DVI-D/HDMI 15
 Preview output video 15
 PREVIEW SATURATION 15
 PREVIOUS SELECT 22, 23

Q

Q 28, 29
 Quad 24
 [QUAD] button 24

R

RATIO 28
 RCS (VR-4HD RCS) 41
 Recording (capturing) 36
 RELEASE 28
 Remote control 41
 RENAME MEMORY 38
 RESET 36
 Reset (Factory reset) 40
 RESOLUTION (EDID) 14
 REVERB 29
 [REVERB] knob 29
 REV SEND 29
 RS-232 41

S

SATURATION 16
 SAVE 38
 SCALING TYPE 15, 16
 Sensitivity (Gain) 26
 [SETUP] button 11
 Setup screen (menu) 11
 SIG/PEAK indicator 26
 SIZE 22
 SOLO 30
 SOLO CLEAR 30
 Sound position (Pan) 27
 Split 23
 [SPLIT] button 23
 STATUS 36
 STILL 20, 25
 Still image 20
 Streaming 36
 Supported OS 36
 SYSTEM FORMAT 13
 [SYSTEM SETUP] button 11

T

Tally 41
 TALLY/GPIO connector 41
 THRESHOLD 28, 29
 TIME 29
 [TIME] knob 18
 Timing (Lip-sync) 35
 [TO PC] knob 27
 TOUCH PANEL CALIBRATION 42
 TOUCH PANEL LOCK 39
 Transition effects 18, 48
 Transition pattern 18, 48
 TRANSITION TIME 18, 19, 25
 TYPE 29

U

USER1-5 ASSIGN 37
 USER1-5 LED COLOR 37
 USER buttons 37

V

[VALUE] knob 11
 Video Capture for VR 36
 Video formats 12, 13, 14
 VIDEO FX 21
 [VIDEO FX/KEY LEVEL] button 21, 25
 VIDEO INPUT SELECT buttons 18
 View mode 10
 Volume 27, 33
 V. POSITION 16, 22
 VR-4HD RCS 41
 V. SIZE 16

W

WEAVE 13
 Weight level 32
 Wipe 18
 [WIPE] button 18
 WIPE PATTERN 18

For the U.K.

IMPORTANT: THE WIRES IN THIS MAINS LEAD ARE COLOURED IN ACCORDANCE WITH THE FOLLOWING CODE.

BLUE: NEUTRAL
BROWN: LIVE

As the colours of the wires in the mains lead of this apparatus may not correspond with the coloured markings identifying the terminals in your plug, proceed as follows:

The wire which is coloured BLUE must be connected to the terminal which is marked with the letter N or coloured BLACK.

The wire which is coloured BROWN must be connected to the terminal which is marked with the letter L or coloured RED.

Under no circumstances must either of the above wires be connected to the earth terminal of a three pin plug.

For the USA

DECLARATION OF CONFORMITY Compliance Information Statement

Model Name : VR-4HD
Type of Equipment : AV Mixer
Responsible Party : Roland Corporation U.S.
Address : 5100 S. Eastern Avenue Los Angeles, CA 90040-2938
Telephone : (323) 890-3700

For the USA

FEDERAL COMMUNICATIONS COMMISSION RADIO FREQUENCY INTERFERENCE STATEMENT

This equipment has been tested and found to comply with the limits for a Class B digital device, pursuant to Part 15 of the FCC Rules. These limits are designed to provide reasonable protection against harmful interference in a residential installation. This equipment generates, uses, and can radiate radio frequency energy and, if not installed and used in accordance with the instructions, may cause harmful interference to radio communications. However, there is no guarantee that interference will not occur in a particular installation. If this equipment does cause harmful interference to radio or television reception, which can be determined by turning the equipment off and on, the user is encouraged to try to correct the interference by one or more of the following measures:

- Reorient or relocate the receiving antenna.
- Increase the separation between the equipment and receiver.
- Connect the equipment into an outlet on a circuit different from that to which the receiver is connected.
- Consult the dealer or an experienced radio/TV technician for help.

This device complies with Part 15 of the FCC Rules. Operation is subject to the following two conditions:

- (1) this device may not cause harmful interference, and
- (2) this device must accept any interference received, including interference that may cause undesired operation.

This equipment requires shielded interface cables in order to meet FCC class B limit.

Any unauthorized changes or modifications not expressly approved by the party responsible for compliance could void the user's authority to operate the equipment.

For Canada

CAN ICES-3 (B)/NMB-3 (B)

For Korea

사용자 안내문

기종별	사용자 안내문
B 급 기기 (가정용 방송통신기자재)	이 기기는 가정용(B 급) 전자파적합기기로서 주로 가정에서 사용하는 것을 목적으로 하며, 모든 지역에서 사용할 수 있습니다.

Manufacturer: 2036-1 Nakagawa, Hosoe-cho, Kita-ku, Hamamatsu, Shizuoka 431-1304, JAPAN

Importer: ENA 23 Zone 1 nr. 1620 Klaus-Michael Kuehnelaan 13, 2440 Geel, BELGIUM



For EU Countries



- UK** This symbol indicates that in EU countries, this product must be collected separately from household waste, as defined in each region. Products bearing this symbol must not be discarded together with household waste.
- DE** Dieses Symbol bedeutet, dass dieses Produkt in EU-Ländern getrennt vom Hausmüll gesammelt werden muss gemäß den regionalen Bestimmungen. Mit diesem Symbol gekennzeichnete Produkte dürfen nicht zusammen mit dem Hausmüll entsorgt werden.
- FR** Ce symbole indique que dans les pays de l'Union européenne, ce produit doit être collecté séparément des ordures ménagères selon les directives en vigueur dans chacun de ces pays. Les produits portant ce symbole ne doivent pas être mis au rebut avec les ordures ménagères.
- IT** Questo simbolo indica che nei paesi della Comunità europea questo prodotto deve essere smaltito separatamente dai normali rifiuti domestici, secondo la legislazione in vigore in ciascun paese. I prodotti che riportano questo simbolo non devono essere smaltiti insieme ai rifiuti domestici. Ai sensi dell'art. 13 del D.Lgs. 25 luglio 2005 n. 151.
- ES** Este símbolo indica que en los países de la Unión Europea este producto debe recogerse aparte de los residuos domésticos, tal como está regulado en cada zona. Los productos con este símbolo no se deben depositar con los residuos domésticos.
- PT** Este símbolo indica que nos países da UE, a recolha deste produto deverá ser feita separadamente do lixo doméstico, de acordo com os regulamentos de cada região. Os produtos que apresentem este símbolo não deverão ser eliminados juntamente com o lixo doméstico.
- NL** Dit symbool geeft aan dat in landen van de EU dit product gescheiden van huishoudelijk afval moet worden aangeboden, zoals bepaald per gemeente of regio. Producten die van dit symbool zijn voorzien, mogen niet samen met huishoudelijk afval worden verwijderd.
- DK** Dette symbol angiver, at i EU-lande skal dette produkt opsamles adskilt fra husholdningsaffald, som defineret i hver enkelt region. Produkter med dette symbol må ikke smides ud sammen med husholdningsaffald.
- NO** Dette symbolet indikerer at produktet må behandles som spesialavfall i EU-land, iht. til retningslinjer for den enkelte regionen, og ikke kastes sammen med vanlig husholdningsavfall. Produkter som er merket med dette symbolet, må ikke kastes sammen med vanlig husholdningsavfall.

- SE** Symbolen anger att i EU-länder måste den här produkten kasseras separat från hushållsavfall, i enlighet med varje regions bestämmelser. Produkter med den här symbolen får inte kasseras tillsammans med hushållsavfall.
- FI** Tämä merkintä ilmaisee, että tuote on EU-maissa kerättävä erillään kotitalousjätteistä kunkin alueen voimassa olevien määräysten mukaisesti. Tällä merkinnällä varustettuja tuotteita ei saa hävittää kotitalousjätteiden mukana.
- HU** Ez a szimbólum azt jelenti, hogy az Európai Unióban ezt a terméket a háztartási hulladéktól elkülönítve, az adott régióban érvényes szabályozás szerint kell gyűjteni. Az ezzel a szimbóllummal ellátott termékeket nem szabad a háztartási hulladék közé dobni.
- PL** Symbol oznacza, że zgodnie z regulacjami w odpowiednim regionie, w krajach UE produktu nie należy wyrzucać z odpadami domowymi. Produktów opatrzonych tym symbolem nie można utylizować razem z odpadami domowymi.
- CZ** Tento symbol udává, že v zemích EU musí být tento výrobek sbírán odděleně od domácího odpadu, jak je určeno pro každý region. Výrobky nesoucí tento symbol se nesmí vyhazovat spolu s domácím odpadem.
- SK** Tento symbol vyjadruje, že v krajinách EÚ sa musí zber tohto produktu vykonávať oddelene od domového odpadu, podľa nariadení platných v konkrétnej krajine. Produkty s týmto symbolom sa nesmú vyhazovať spolu s domovým odpadom.
- EE** See sümbol näitab, et EL-i maades tuleb see toode olemprügist eraldi koguda, nii nagu on igas piirkonnas määratletud. Selle sümboliga märgitud tooteid ei tohi ära visata koos olmeprügiga.
- LT** Šis simbolis rodo, kad ES šalyse šis produktas turi būti surenkamas atskirai nuo buitinių atliekų, kaip nustatyta kiekviename regione. Šiuo simboliu paženklinėti produktai neturi būti išmetami kartu su buitiniomis atliekomis.
- LV** Šis simbols norāda, ka ES valstīs šo produktu jāievāc atsevišķi no mājsaimniecības atkritumiem, kā noteikts katrā reģionā. Produkts ar šo simbolu nedrīkst izmest kopā ar mājsaimniecības atkritumiem.
- SI** Ta simbol označuje, da je treba proizvod v državah EU zbirati ločeno od gospodinskih odpadkov, tako kot je določeno v vsaki regiji. Proizvoda s tem znakom ni dovoljeno odlagati skupaj z gospodinskimi odpadki.
- GR** Το σύμβολο αυτό υποδηλώνει ότι στις χώρες της Ε.Ε. το συγκεκριμένο προϊόν πρέπει να συλλέγεται χωριστά από τα υπόλοιπα οικιακά απορρίμματα, σύμφωνα με όσα προβλέπονται σε κάθε περιοχή. Τα προϊόντα που φέρουν το συγκεκριμένο σύμβολο δεν πρέπει να απορρίπτονται μαζί με τα οικιακά απορρίμματα.

For China

有关产品中所含有害物质的说明

本资料就本公司产品中所含的特定有害物质及其安全性予以说明。

本资料适用于2007年3月1日以后本公司所制造的产品。

环保使用期限



此标志适用于在中国国内销售的电子信息产品，表示环保使用期限的年数。所谓环保使用期限是指在自制造日起的规定期限内，产品中所含的有害物质不致引起环境污染，不会对人身、财产造成严重的不良影响。

环保使用期限仅在遵照产品使用说明书，正确使用产品的条件下才有效。不当的使用，将会导致有害物质泄漏的危险。

产品中有毒有害物质或元素的名称及含量

部件名称	有毒有害物质或元素					
	铅(Pb)	汞(Hg)	镉(Cd)	六价铬(Cr(VI))	多溴联苯(PBB)	多溴二苯醚(PBDE)
外壳(壳体)	X	O	O	O	O	O
电子部件(印刷电路板等)	X	O	X	O	O	O
附件(电源线、交流适配器等)	X	O	O	O	O	O

O: 表示该有毒有害物质在该部件所有均质材料中的含量均在 SJ/T11363-2006 标准规定的限量要求以下。
X: 表示该有毒有害物质至少在该部件的某一均质材料中的含量超出 SJ/T11363-2006 标准规定的限量要求。因根据现有的技术水平, 还没有什么物质能够代替它。

