



# Operating Instructions

PBM-3G Series Monitors



PBM-232-3G

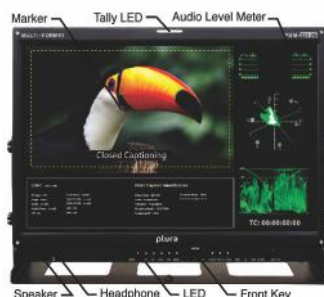

Speaker Headphone LED Front Key  
PBM-224-3G

## PBM-3G Series

PBM-307-3G

PBM-209-3G

PBM-310-3G

PBM-217-3G

PBM-317-3G

PBM-220-3G

PBM-221-3G

PBM-224-3G

PBM-224-3G-10

PBM-232-3G

PBM-332-3G

PBM-240-3G

PBM-246-3G

PBM-346-3G

PBM-347-3G

PBM-255-3G

PBM-265-3G

PBM-270-3G

# Contents

---

Safety Precautions .....	5
1. Overview .....	7
2. General features .....	7
3. Functional Explanation of each Part.....	8
3-1. Front Panel.....	8
3-2. Front Keys arrangements.....	9
3-3. Front Keys Operations.....	10
3-4. Front panel LED Operations .....	10
3-5. Rear Panel .....	10
3-6. Connection Details .....	10
3-7. DC Battery in (PBM-317,12V,PBM-224,24V) .....	10
3-8. Remote Pin assignment (RJ-45).....	11
3-9. Interface Description .....	11
4. Menu Overview .....	12
4-1. To show and hide the Menu .....	12
4-2. To go to the next level .....	12
4-3. To go back to the previous level .....	12
4-4. Typical Menu Operation.....	12
5. Basic Operation .....	13
5-1. Turning on the Monitor.....	13
5-2. Volume Adjustment .....	13
5-3. On Screen Menu Language Selection .....	13
6. On Screen Menu Selection and Adjustment .....	14
6-1. How to adjust the OSD screen .....	14
7. Select Video Input .....	15
7-1. How to Select Video Source by OSD.....	15
8. Video Menu Options .....	16
8-1. Video Menu of each input modes.....	16
8-2. Adjust.....	16
8-3. Color temperature control .....	16
8-4. Scan .....	16
8-5. Aspect ratio .....	17
8-6. Zoom .....	18
8-7. Mono/Blue only .....	18
8-8. PC Menu (pc mode only) .....	18
8-9. Flip.....	19
8-10. NR (Noise Reduction).....	19
8-11. Dual Link Mode (SDI only).....	19

- 9. Audio Menu Options ..... 20
  - 9-1. SDI 1/ SDI 2 Audio Group ..... 20
  - 9-2. SDI 1/ SDI 2 Audio Output Channel..... 20
  - 9-3. Level Meter ..... 20
  - 9-4. Level Meter Type ..... 20
  - 9-5. Level Meter Position ..... 20
  - 9-6. Level Meter Scale..... 21
  - 9-7. Audio Mode ..... 22
  - 9-8. Volume..... 22
- 10. Marker Menu Options ..... 23
  - 10-1. Marker & user Marker ..... 23
  - 10-2. Safety area..... 23
  - 10-3. Center Maker ..... 24
  - 10-4. Marker Width ..... 24
  - 10-5. Marker color ..... 24
  - 10-6. GPI Preset 1 & GPI Preset 2 ..... 24
- 11. GPI Menu Options ..... 25
  - 11-1. GPI Control & GPI# ..... 25
- 12. SETUP Menu Options ..... 26
  - 12-1. SETUP Load & SETUP Save .....26
  - 12-2. Function 1 & Function 2 & Function 3..... 26
  - 12-3. On Screen Display..... 27
  - 12-4. OSD Option ..... 27
  - 12-5. Time Code..... 27
  - 12-6. Under Monitor Display (color: Tally R/G mode Action) ..... 27
  - 12-7. Input Name ..... 28
  - 12-8. Info Message..... 28
  - 12-9. SDI Signal State..... 28
  - 12-10. Advanced..... 29
  - 12-11. Information ..... 29
  - 12-12. Control ..... 29
  - 12-13. Screen Saver..... 29
  - 12-14. Screen Control ..... 30
  - 12-15. Fan Control ..... 31
  - 12-16. X768 Mode ..... 31
  - 12-17. Caption ..... 32
  - 12-18. Waveform Format..... 32
  - 12-19. Y-Pb-Pr Waveform ..... 32

12-20. Y-Waveform + Vector Scope .....	32
12-21. Double .....	32
12-22. Y-Waveform + Vector Scope Trans .....	33
12-23. Set ID & active Set ID .....	33
13. PIP (Picture in Picture) .....	34
13-1. POP ON/OFF .....	34
13-2. Input Source .....	34
13-3. Aspect Ratio .....	34
13-4. Position .....	34
13-5. PIP Blend .....	35
13-6. PIP Swap .....	35
13-7. Sound Select .....	35
13-8. Sub Window Function .....	35
14. Remote Control Key Arrangements .....	36
14-1. IR- Remote Controller Descriptions .....	37
15. OSD Tree .....	38
15-1. Video .....	39
15-2. Audio .....	40
15-3. Marker .....	41
15-4. GPI .....	42
15-5. SETUP .....	43
15-6. PIP .....	44
16. Supported Input Modes .....	45
16-1. Supported Signals .....	45
16-2. SDI Input .....	46
16-3. PC & DVI Input .....	46
17. Mechanical Dimension .....	48
17-1. PBM-307-3G .....	48
17-2. PBM-209-3G .....	48
17-3. PBM-310-3G .....	48
17-4. PBM-317-3G & PBM-217-3G .....	49
17-5. PBM-220-3G .....	49
17-6. PBM-221-3G .....	49
17-7. PBM-224-3G & PBM-224-3G-10E .....	50
17-8. PBM-232-3G .....	50
17-9. PBM-332-3G .....	50
17-10. PBM-240-3G .....	51
17-11. PBM-246-3G .....	51
17-12. PBM-346-3G .....	51
17-13. PBM-347-3G .....	52
17-14. PBM-255-3G .....	52
17-15. PBM-265-3G .....	52
17-16. PBM-270-3G .....	53

### Precaution

*Before operating this unit, please read this manual carefully.*

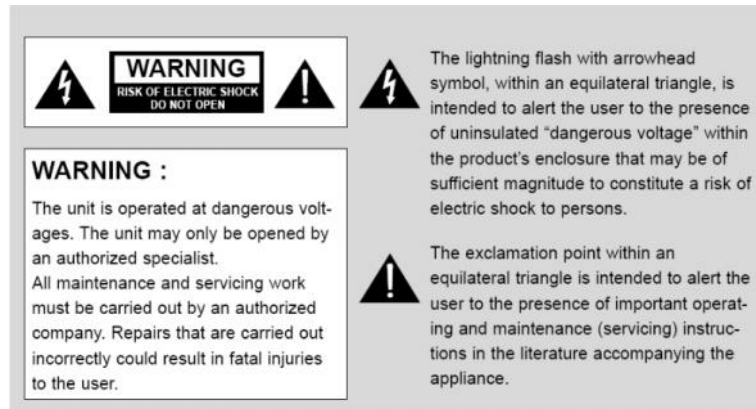

The image shows a collection of warning labels and symbols. At the top left, there is a rectangular label with a lightning bolt symbol on the left, a central box containing the text "WARNING RISK OF ELECTRIC SHOCK DO NOT OPEN", and an exclamation mark symbol on the right. Below this is a larger rectangular label with the heading "WARNING :" followed by text: "The unit is operated at dangerous voltages. The unit may only be opened by an authorized specialist. All maintenance and servicing work must be carried out by an authorized company. Repairs that are carried out incorrectly could result in fatal injuries to the user." To the right of these labels are two separate symbols: a lightning bolt in a triangle and an exclamation mark in a triangle. Next to each symbol is a short paragraph explaining its meaning.

**WARNING :**  
The unit is operated at dangerous voltages. The unit may only be opened by an authorized specialist. All maintenance and servicing work must be carried out by an authorized company. Repairs that are carried out incorrectly could result in fatal injuries to the user.

The lightning flash with arrowhead symbol, within an equilateral triangle, is intended to alert the user to the presence of uninsulated "dangerous voltage" within the product's enclosure that may be of sufficient magnitude to constitute a risk of electric shock to persons.

The exclamation point within an equilateral triangle is intended to alert the user to the presence of important operating and maintenance (servicing) instructions in the literature accompanying the appliance.

#### **WARNING:**

To reduce the risk of any electric shock, please do not remove the back cover. No user serviceable parts inside. Refer any service matters to qualified service personnel. To prevent fire or shock hazard, do not expose the rear of the set to rain or moisture. Do not rub, clean or hit the Active Matrix LCD with object that may scratch, mark, or damage the Active Matrix LCD permanently.

#### **CAUTION:**

Unauthorized tampering with the inside of the monitor invalidates the warranty.

The manufacturer shall not warrant for any damage caused by improper maintenance and/or repair or work by third parties.

Important safeguards for you and your new product:

Your product has been manufactured and tested with your safety in mind. However, improper use can result in potential electrical shock or fire hazards. Please read and observe the following safety points when installing and using your new product and save them for future reference.

- 1. Read Instructions**
- 2. Follow Instructions**  
*All operating and use instructions should be followed.*
- 3. Retain Instructions**  
*The safety and operating instructions should be retained for future reference.*
- 4. Notice Warnings**  
*All warnings on the product and in the operating instructions should be adhered to.*
- 5. Cleaning**  
*Disconnect the unit from the mains before cleaning the unit. Do not use abrasive cleaners. Use a damp cloth ONLY for cleaning.*
- 6. Water and Moisture**  
*Do not use this product near water.*
- 7. Transporting Product**  
*This product should be moved with care. Quick stops, excessive force and uneven surfaces may cause the product damages.*
- 8. Accessories**  
*Do not use accessories not recommended by **PLURA Inc.** as they may cause hazards.*
- 9. Ventilation**

## Safety Precautions

---

Do not block any of the ventilation openings.

Install in accordance with the manufacturer's instructions.

### 10. Power Sources

This product should be operated only from the type of power source indicated on the marking label. If you are not sure of the type of power supply, consult your power supply company.

### 11. Power Lead Polarization

This product is equipped with a three-wire grounding-type cord. This is a safety feature. Do not use any other type power cord.

### 12. Power Cord Protection

Power-supply cords should be dressed so that they are not likely to be pulled or pinched by items placed upon or against them.

### 13. Lightning

For added protection for this product during a lightning storm, or when it is left unattended and unused for long periods of time, unplug it from the wall outlet. This will prevent possible damage to the product due to lightning and power-line surges.

### 14. Grounding the product

This product must be grounded properly to comply with the safety regulations in the country of use. If you are unsure of these regulations, please consult a qualified electrician.

### 15. Servicing

Do not attempt to service this product by yourself as opening or removing covers may expose you to dangerous voltages or other hazards. Refer all servicing to qualified service personnel.

### 16. Damage Service Required

Isolate this product from the mains and refer to qualified service personnel under the following conditions:

- A. If the power-supply cord or plug is damaged.
- B. If the front LCD front has been damaged.
- C. If the product does not operate correctly by following the operating instructions. Use only the user control buttons any improper adjustment of other controls may result in damage and will often require extensive work by a qualified technician to restore the product to its normal operation.
- D. If the product has been dropped.
- E. If the product exhibits a distinct change in performance.

### 17. Safety Check

Upon completion of any service or repairs to this product, ask the service technician to perform safety checks to determine that the product is in proper operating condition and the warranty seal is provided.

### 18. Mounting

The product should be mounted on a wall as recommended in the instructions.

### 19. Power

This set operates on an AC supply; the voltage is as indicated on the label on the Manual. This appliance must be earthed at all times through the chassis as well as through the power lead.



Note

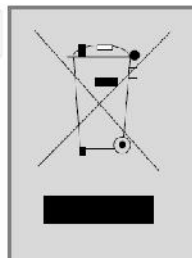

This product is designed and manufactured with high quality materials and components which can be recycled and reused. This symbol means that electrical and electronic equipment, at their end-of-life, should be disposed of separately from your household waste. Please, dispose of this equipment at your local community waste collection/recycling centre. In the European Union there are separate collection systems for used electrical and electronic product. Please, help us to conserve the environment we live in!

## 1. Overview

---

The new PBM-3G Plura Precision Broadcast LCD Series which is built with Grade A LCD Panel that supports 3Gb/s –1080/60P input, Powerful Dual 3Gb/s input display with advanced Waveform / Vector scope, Closed Caption or Teletext 801 & subtitle for North American or Australian markets respectively, VPID, IMD and many more . . .

## 2. General Features

---

- 3Gb/s-1080/60p
- 2 x Auto-detect HD-SDI, SDI with active loops (3 Gb/s / 1.485Gb/s / 270Mb/s)
- Dual HD SDI YPbPr 4:2:2 – Dual HD SDI YPbPr/RGB 4:4:4 & 2K
- RGB, YUV, Y/C, Composite, UXGA, DVI & HDMI (DHCP)
- Complies with EBU-3320 TECH, SMPTE-C and ITU-R BT.709 Standards
- (ICAC) - Plura Intelligent Connection for Alignment & Calibration
- Closed Caption (608/708) – North American Market
- Teletext 801 & Subtitle OP-47 – Australia & NZ Market
- Cutting edge De-interlacing and Scaling Technology
- Fast Response Time for high motion video
- RGB 10 Bit Digital Signal Processing
- 178° Viewing Angle Display
- Internal Monitor Display (IMD)
- Underscan / Overscan / Normal / Zoom
- Pixel to Pixel Mode, Tally, DC Operation
- Display LTC & DVITC time code with line select
- Internal Pattern Generator and Wall Control System
- Built In Stereo Speaker, 16 CH Audio Metering Display
- Analog & Embedded Audio Input, Digital Audio Decoding
- Color Temperature – User, VAR, Adjustable (11000K TO 3200K)
- Various and User defined Markers Display, Safe Area in HD & SD
- Picture and Picture (PaP), Picture in Picture (PIP) display / Blend
- Intuitive OSD Display, Graphic based, 6 Languages (UNICODE System)
- Display Advanced Waveform & Vector Scope simultaneously with line select
- Programmable 3 User Front Pushbutton Controls, GPI & RS232 Remote Control
- OPTIONS: Battery Mount: PBM-AB (Anton Bauer), PBM-VM (V-Mount), Hard Carry Case, Rack mount & Soft Carry case



### 3. Functional explanation of each Part

#### 3-1. Front panel



#### Front Panel

PBM-307-3G & PBM-209-3G

PBM-217-3G, PBM-220-3G & PBM-224-3G



#### Front Panel

PBM-232-3G, PBM-240-3G, PBM-246-3G



# 1. Overview

## 3-2. Front Key Arrangements

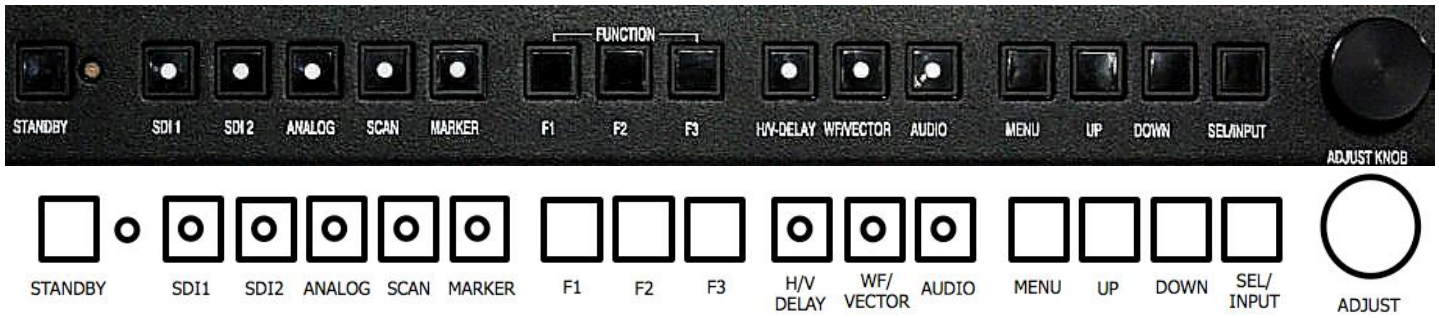

## 3-3. Front Key Operations

Key Name	Operation
Stand By	Power on/off Button. This button is operated after being pressed about 3 seconds.
SEL/INPUT	Activates OSD menu of input source selecting. Changes input source. Executes functions (by OSD help commands) in main OSD menu.
Down	Decreases Audio volume of speaker. Decreases values of user menu in main OSD menu. Executes function (by OSD help commands) in main OSD menu.
UP	Increases Audio volume of speaker. Increases values of user menu in main OSD menu. Executes function (by OSD help commands) in main OSD menu.
Menu	Activates main OSD menu. Navigates higher menu in main OSD menu. Stops auto frequency searching. Exits OSD menu.
Audio	Activates Audio Lever Meter
WF/Vector	Activates Waveform & Vector Scope (SDI only) SETUP Menu Waveform format selection
Blue Only	Mono color / Blue ONLY selection
H/V-DeLay	Activates 'H & V' blanking display 'H DeLay' -> 'V DeLay' -> 'HV DeLay' -> off
Function 1	Executes functions of user selected
Function 2	Undefined, aspect, Mono/Blue only, Audio channel, Safety area marker, time code, analog caption, Audio mute, Still image, Zoom, flip, Gamma select, PIP func & input, Sub win
Function 3	Sub win part
Marker	Draw Marker on Screen ( off -> 16:9 -> 4:3 ... -> 2.35:1 )
Scan	executes Scan function ( over-Scan -> Zero-Scan -> under Scan-> Pixel to Pixel)
SDI1	Select SDI 1 source
SDI 2	Select SDI 2 source
Analog	Select analog source directly ( 'composite1' -> 'composite2' -> 'composite3' -> 'S-video' -> 'G.B.R' -> 'Y.Pb.Pr' -> 'Pc' -> 'HDMI' -> 'DVI' )
Adjust	Adjust Video Menu (Brightness -> contrast -> color -> Sharpness->Phase & tint) turn right = 'UP' button turn left = 'Down' button

## 3-4. Front Panel led Operations

- Green Led turned on during executing any key function and when is Power on
- Stand-by mode is LED Red

## Speaker Out

Speaker R out	8 ohm±15%, Max 2W + 2W
Speaker L out	

### 3. Functional explanation of each Part continued

#### 3-5. Rear Panel

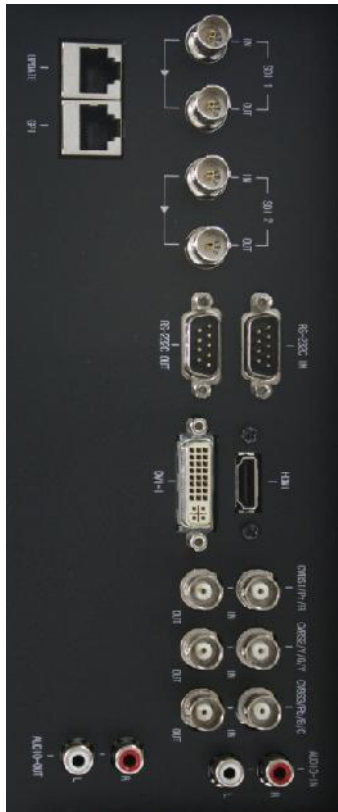

Rear Panel

#### 3-6. Connection details

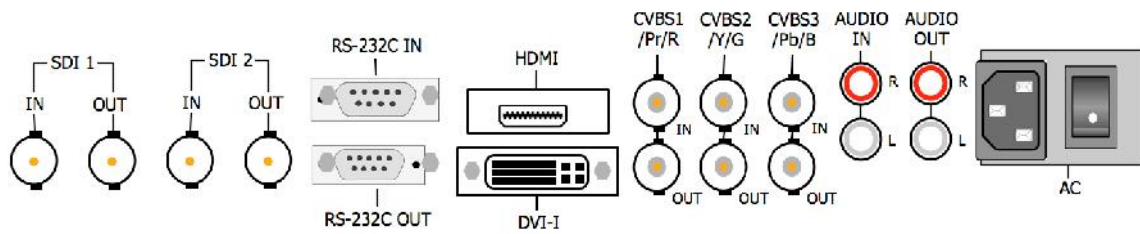

#### 3-7. DC 12V/24V Battery IN PBM-217 ->12V, PBM-224 ->24V - PBM-224 ->12V (S/N starts with 17APL)

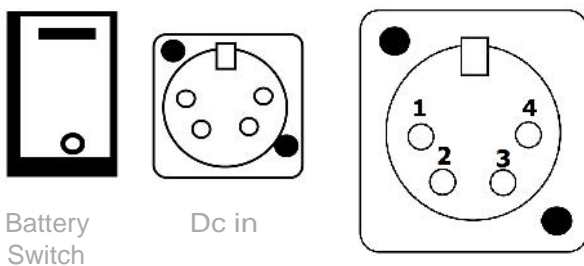

PIN No.	description
1	GnD
2, 3	
4	+ 12V/24V

### 3. Functional explanation of each Part continued

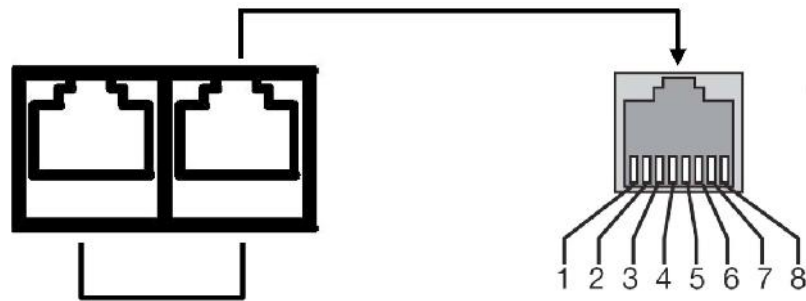

#### 3-8. Remote PIN Assignment

8 Pin	Common(GND)	4 Pin	GPI 4 Port
7 Pin	GPI 7 Port	3 Pin	GPI 3 Port
6 Pin	GPI 6 Port	2 Pin	GPI 2 Port
5 Pin	GPI 5 Port	1 Pin	GPI 1 Port

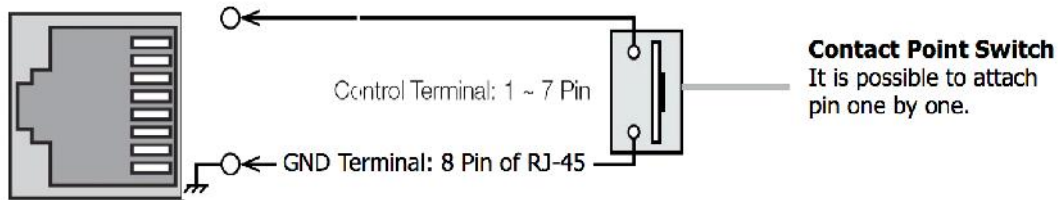

#### 3-9. Interface description

Interface	description
SDI 1 IN SDI 2 IN	HD SDI / SD SDI input
SDI 1 OUT SDI 2 OUT	SDI 1, SDI 2 Loop out
RS-232 IN	update/Multi control/auto color calibration
RS-232 OUT	Multi control out
HDMI	High Definition Multimedia input
DVI-I	DVI-I type Digital / analog Pc-RGB Video input High Definition Multimedia input compatible
CVBS1/Pr/G IN CVBS2/Y/R IN CVBS3/Pb/B IN	Gbr (SoG sync) input Y, Pb, Pr component Video input CVBS / composite input
CVBS1/Pr/G OUT CVBS2/Y/R OUT CVBS3/Pb/B OUT	Component/GBR/composite1,2,3/ S-Video Loop out
Audio R IN Audio L IN	DVI-I/component/GBR/composite1,2,3/S-Video Audio input
Audio R OUT Audio L OUT	Audio Monitor out
AC IN	AC 90V ~ 240V, 50Hz/60Hz
DC IN	PBM-217: DC 11V ~ 17V , PBM-224: DC 24V, PBM-224: DC 12V (S/N starts with 17APL)
UPDATE/Ethernet	Firmware Upgrade
GPI	GPI 1 ~ 7 control Port

## 4. Menu Overview

IN the menu system, there are several ways to customize the menu settings provided.

Most menus consist of three levels to set up the options, but some require greater depth for the variety of settings. If you press the MENU button, only the first and second level of the menu system will appear on the monitor screen. The third level can be displayed by pressing SEL/INPUT. If a menu has more than three levels, the POP-up dialogue box will be displayed as the fourth or fifth level.

### 4-1. Show and hide the Menu

Press the Menu button to display the menu. A second press of the Menu button will take you back to monitor viewing.

### 4-2. Go to the next level

Press SEL/INPUT button.

### 4-3. Go back to the previous level

Press Menu button



### 4-4. Typical Menu Operation

1. Press Menu button: the main menu will appear.
2. use UP/DOWN button to select the desired menu option (icon).
3. While the desired menu option is selected, press SEL/INPUT to move to the second level.
4. use UP/DOWN button to select the second menu option.
5. Press SEL/INPUT to move to the third level: Some menu options require additional steps.
6. Press Menu to return to the previous menu until you don't see the Menu any longer.

## 5. Basic Operation

---

### 5-1. Turning On the Monitor

1. First, connect power cord correctly. At this moment, the monitor switches to standby or power on mode. In standby mode, in order to turn monitor on, press the St-By button for at least 3 seconds.
2. Select the source by using SEL/INPUT button on Keypad in front of monitor

### 5-2. Volume Adjustment

1. Press the adjust knob and turn the dial left or right or use the UP/DOWN button on Keypad.
2. If you want to switch the Audio off, press the **function** (Audio mute) or press down button or turn knob left until the volume bar displays zero.
3. You can cancel this function by pressing the **function** (Audio mute) or volume control button.

### 5-3. On Screen Menu language Selection



- SETUP -> advanced -> OSD -> Language
- The menu can be shown on the screen in the selected language.
- Supported Languages: English, Spanish, Portuguese, German, French, Italian

## 6. ON Screen Menu Selection and Adjustment

### 6-1. how to adjust the OSD screen

1. Press the Menu button and then UP/DOWN button to select each menu.
2. Press the SEL/INPUT button and then use UP/DOWN (SEL/INPUT)/Menu button to display the available menus.



(Monitor OSD (On Screen display) may differ slightly from what is shown in this manual.)

## 7. Select Video Input

---

### 7-1. how to Select Video Source by OSD

1. Press the SEL/INPUT button and then UP/DOWN button to select each video source.
2. Press the SEL/INPUT button to go to desired video source.
3. If input name is enabled, the SEL/INPUT button goes into input name edit mode instead of selecting source.

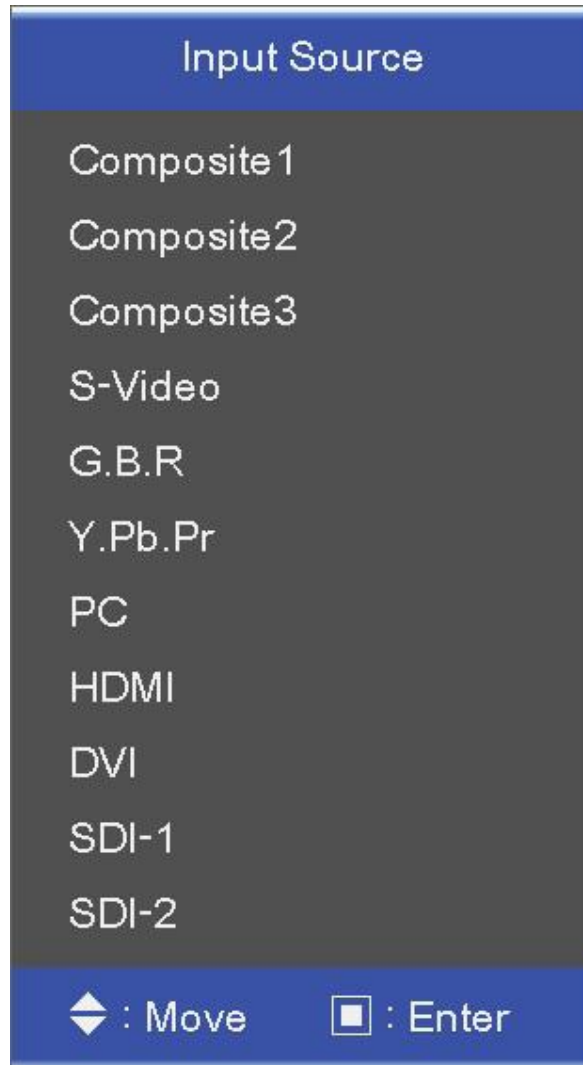



## 8. Video Menu Options

### 8-1. Video Menu of each Input modes



< Video (NTSC) Picture menu>



< PC Picture menu>



< SDI, HDMI Picture menu>

### 8-2. Adjust

-adjust the values of Brightness, contrast, color, tint and Sharpness directly from -50 to 50

Contrast, Brightness, Sharpness, color (all Sources), tint (PC, DVI, HDMI, component) n/a, Phase (component) n/a.



### 8-3. Color Temperature Control

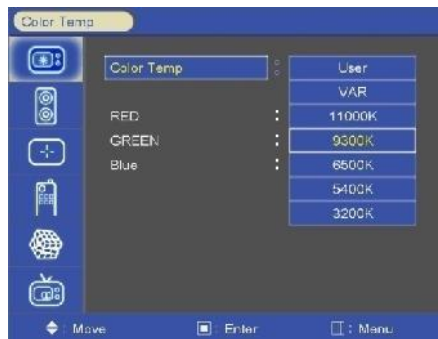

- For Setting the color temperature or adjusting RGB gain value directly

- User (user Setting RGB gain value), VAR(3200K ~ 11000K), often used value(11000K, 9300K, 6500K, 5400K,3200K)

### 8-4. Scan

1. Over Scan – 95% input size and fit the selected display size
2. Zero Scan – 100% input size and fit the selected display size
3. Under Scan – 105% input size and fit the selected display size
3. Pixel to Pixel – Display size is an input size. If input resolution is bigger than panel size, fit the panel size, example show below



## 8. Video Menu Options continued

### 8-4. Scan continued

Input: 1080i

Panel Resolution: 1366x768



### 8-5. Aspect Ratio



- For setting the aspect ratio.
- Full Screen: the images are displayed with a panel size.
- Full Screen, 16:9, 4:3, 14:9, 13:9, 1.85:1, 2.35:1: the images are displayed with each aspect ratio.
- PC mode: full Screen & 4:3 only

## 8. Video Menu Options continued

### 8-6. Zoom

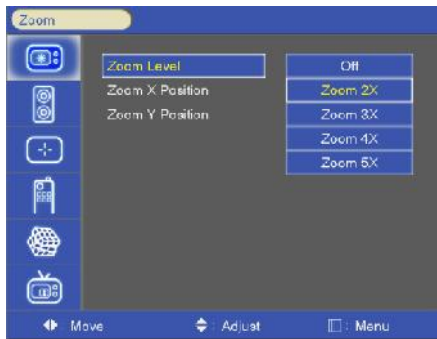

- Can see the enlarged video by (2X, 3X, 4X, 5X) ratios.
- If user select the Zoom 2X, can see the below yellow box in picture.
- Press Select or enter button, user can see the enlarged picture.
- Menu key or exit key escape the zoom mode.
- Example (3X3)

Zoom X position: coordinate of video image's column position.

Zoom y position: coordinate of video image's row position.

### 8-7. Mono/Blue Only

- Mono color: for selecting monochrome images.
- Blue only: images in blue color



### 8-8. PC Menu (pc mode only)



- Only operate PC input mode
- Select auto-adjust and adjust Phase, HV position, frequency
- Auto-adjust automatically set the optimum values of Phase, HV position and frequency.

## 8. Video Menu Options continued

---

### 8-9. Flip



< H-flip off >



< H-flip on >

-H-flip Display on/off

### 8-10. NR (Noise Reduction)

-noise reduction on/off. (SDI mode only)

### 8-11. dual link Mode (SDI Only)

-Dual Link Mode select. (Auto / Off / RGB444 / YCbCr 444/ YCbCr 422)

- If SDI signal has a video payload identification and Dual Link Mode set auto mode. Dual link is set automatically.

## 9. Audio Menu Options

### 9-1. SDI 1/ SDI 2 Audio Group

- Select primary or secondary Audio group to extract. (Group 1~4)

### 9-2. SDI 1/ SDI 2 Audio Output Channel

- Audio output channel source select.  
(channel1~4, channel1/2, channel3/4, off)



### 9-3. level Meter

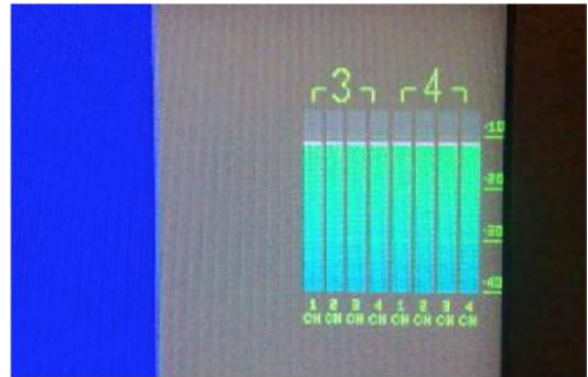
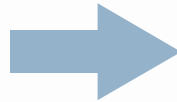

- Display the Audio level meter on screen in SDI input.
- Audio level meter cannot be displayed with OSD.
- SDI input can support 16 CH embedded Audio, other inputs can only support 2 CH Audio

### 9-4. level Meter type

- Pair: respectively channel with right and left display
- Group: respectively group display

### 9-5. level Meter Position

- Level Meter Position selects. (TOP/Middle/Bottom)

## 9. Audio Menu Options continued

### 9-6. level Meter Scale



- Level Meter Scale mode selects. (BBC / EBU / VU / NORDIC / DIGITAL / DIN / EXPAND DIN)

### AUDIO SCALES

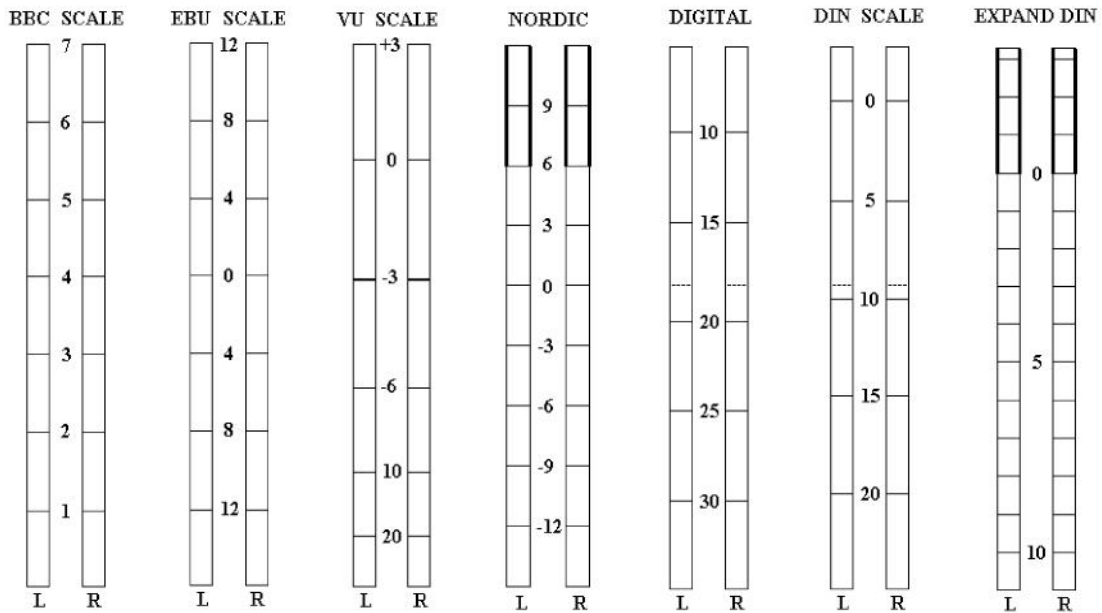

### Audio Level Meter Scales: PBM-3G

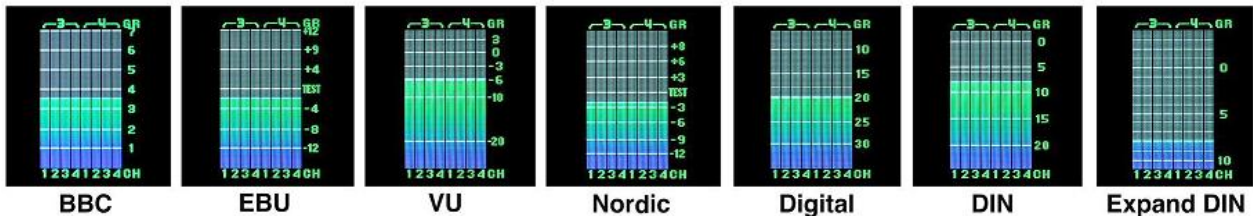

### 9-7. Audio Mode

- Sound mode selects (Stereo/Dual Mono)



## 9. Audio Menu Options continued

### 9-8. Volume

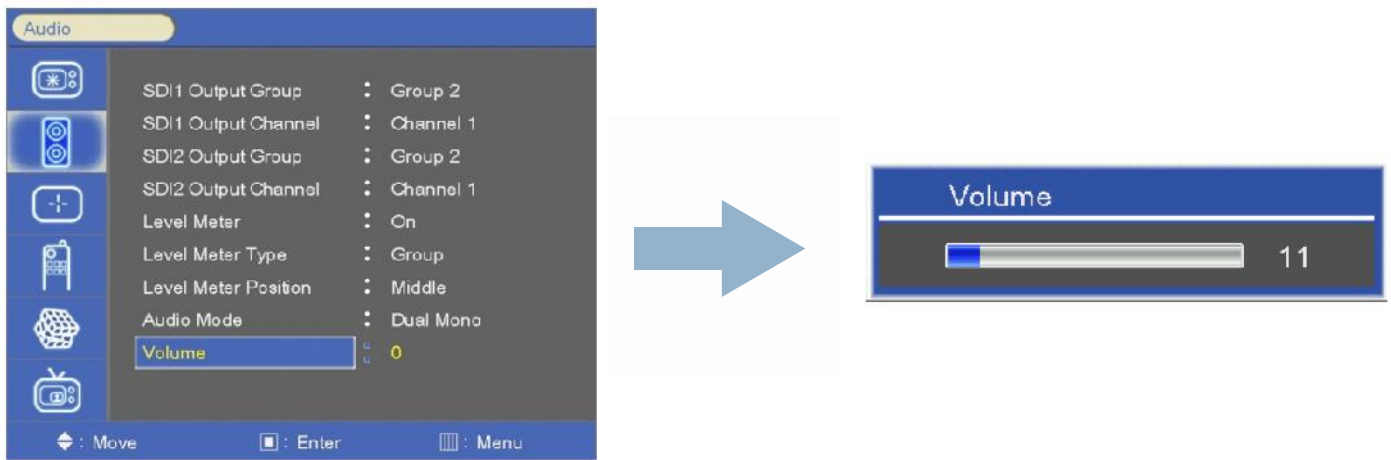



# 10. Marker Menu Options

## 10-1. Marker & user Marker



< Marker >



< User Marker >

1. Marker : 16:9, 4:3, 14:9, 13:9, 1.85:1, 2.35:1, 1.85:1&4:3, user1, user2, user3 fitted panel size marker on screen.
2. User Marker: the user can set the different Marker size Settings. (Below panel size)

### Example (1440x900 Panel)



16:9 (16:9 Marker)



16:9 (4:3 Marker)

## 10-2. Safety Area

-Safety area: Draw dotted line Marker on screen in case of images.  
 (16:9 95/93/90/88/80%, 4:3 95/93/90/88/80%,  
 EBU action 16:9/14:9/4:3, EBU Graphic 16:9/14:9/4:3)



## 10. Marker Menu Options continued

### 10-3. Center Maker

- “+” Marker on center of screen



### 10-4. Marker Width

- Marker line thickness setting. (0~10)

### 10-5. Marker Color

- Marker Line color: Select Marker line color (White, Yellow, Blue, RED, Black)
- Safety Line color: Select Safety line color (White, yellow, Blue, RED, Black)
- Marker Back color: Select Marker Back color. (none, Gray, White, Blue, Black)
- Safety Back color: Select Safety Back color. (none, Gray, White, Blue, Black)
- Marker BK Blend color: Select Marker blending level. (0 ~ 5)
- Safety BK Blend color: Select Safety blending level. (0 ~ 5)

### 10-6. GPI Preset 1 & GPI Preset 2

- For setting the marker to use by GPI controller.
- GPI preset markers are only worked by GPI controller



# 11. GPI Menu Options

## 11-1. GPI Control & GPI#

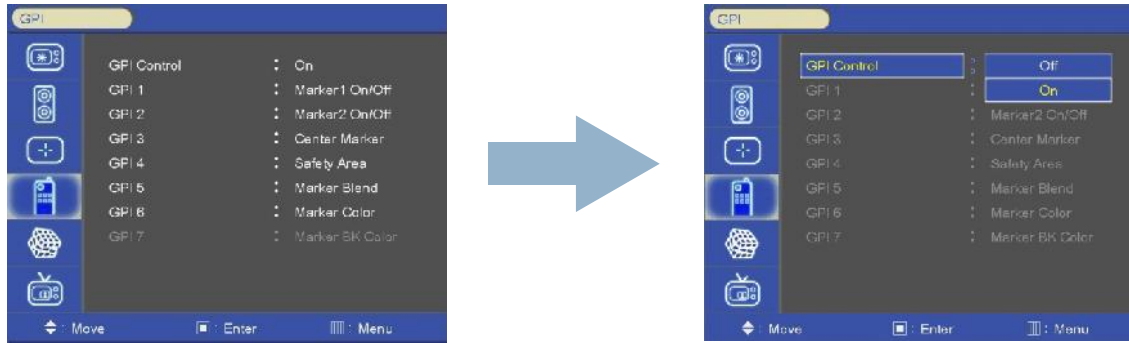

- For allocating functions to particular GPI pins.
- When remote control operations are to be performed using the GPI controller.
- GPI control: GPI function enable/Disable
- GPI 1 ~ 7

GPI function	description
UNDEFINED	not set (no function allocated)
Marker1 on/off, Marker2 on/off	Displays the markers which have been set by the GPI Preset1, 2 items on the screen.
center Marker	Displays the center marker.
Safety area	Displays the Safety area.
Marker Blend	Select marker background blend level.
Marker color	Select maker line color.
Marker BK color	Select marker background color.
Tally R, Tally G, Tally Y	For the red, Green or yellow tally lamp. yellow when both r & G are selected
Scan	over Scan/Zero Scan/under Scan/ Pixel to
input composite1, input G.B.R, input SDI1, input SDI2,input Y.Pb.Pr , input PC , input DVI, input HDMI	Switches the input source.
Menu Key, enter Key, up Key, Down Key Left Key, right Key	Use the key function by GPI.
GPI 7 : Power Key(fixed)	

## 12. Setup Menu Options continued

### 12-1. SETUP load & SETUP Save



- SETUP Load: Load user saved values or default value - SETUP Save: Save user setting values at user 1, 2, 3.

### 12-2. Function 1 & Function 2 & Function 3

» function 1, 2, 3: Select the function to be allocated to the function 1, 2, 3 buttons



function1&2 button	description
UNDEFINED	not set (no function allocated)
aspect	Sets the aspect ratio of the images
Mono/Blue only	execute Mono color or Blue only
Audio channel	Select the extract the embedded Audio channel in SDI input.
Marker size	Marker size Select
Safety area Marker	Safety area Select
time code	time code Display
caption	closed caption (analog Signal only)
Audio mute	toggles Audio status of speaker/headphone in mute.
Still image	Toggles Video status between motion and still image.
Zoom	Zoom function is operated(off, 2x, 3x, 4x, 5x)
flip	H-flip Display on/off
Gamma Select	Select Gamma curve.
PIP func & input	change PIP input sources when PIP is on
Sub Win full	Display same full images on PIP screen
Sub Win Part	Display same parts(4:3) images on PIP screen

## 12. Setup Menu Options continued

### 12-3. On Screen display



### 12-4. OSD Option

- » Language: Select a language for the menu to appear in. (English, Spanish, Portuguese, German, French, Italian)
- » OSD Position: L-T, R-T, C, L-B, R-B
- » Message OSD: Message OSD display enable/disable
- » OSD transparency: Disable blending OSD background with video image.

### 12-5. Time code

- » time code enable: time code Display (off/LTC/VITC, SDI only)
- » time code size: time code size select. (Small, Middle, Large)
- » time code Position: time code display position selects (L-T, C-T, R-T, L-B, C-B, R-B)
- » time code transparency: Disable blending time code background with video image. (0%, 25%, 50%, 75%, 100%)

### 12-6. Under Monitor display (color: tally R/G mode action)

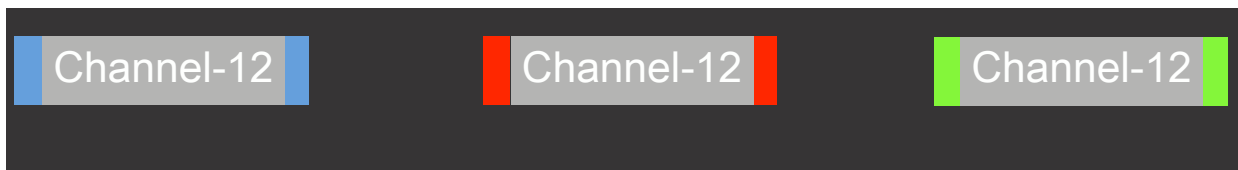

- » UMD: UMD display on/off
- » UMD character: UMD character Select
- » UMD Position: UMD display position select (L-T, C-T, R-T, L-B, C-B, R-B)
- » UMD fG color: UMD character color Select (RGB\_255\_192\_128\_transparency)
- » UMD BG color: UMD BG color Select (RGB\_255\_192\_128\_transparency)

## 12. Setup Menu Options continued

### 12-7. Input Name

Display user name instead of input source name on source OSD and message OSD

- Example and naming method

1) If input name is enable, user can see the below input Source OSD

2) Press function 3 on the controller to go into name edit mode

3) Make name in 5 characters by UP/DOWN key

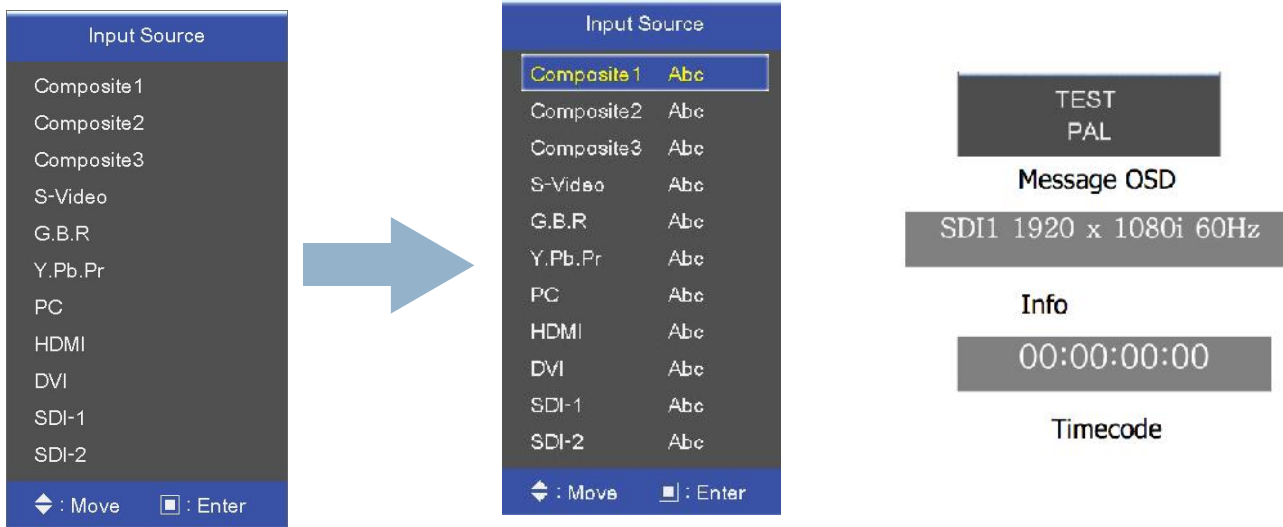

### 12-8. Info Message

- Info Message Display on/off

### 12-9. SDI Signal state

- SDI Signal date display on/off  
(H/V sync, image, Audio, Audio Phase,  
EDH packet, EDH FF CRC,  
EDH APCRC, SAC, EAV, VPI)





## 12. Setup Menu Options continued

### 12-10. Advanced

- Information, control, Screen Saver, Screen control, fan control, x786 Mode



### 12-11. Information

- Version, release day, release time and operating time

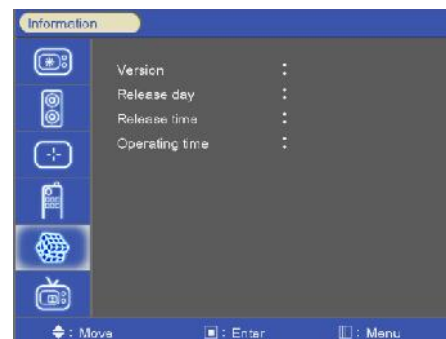

### 12-12. Control

- » front LED: front LED on/off
- » Local enable: Power, up and down keys are only enabled, when Local enable is off.
- » remote control (option): Select the controller of local or remote. If remote controller is selected, both local (front key) and remote are enabled. However select local, local key only operated.



### 12-13. Screen Saver

- » Blue Screen: enables screen saver functions to avoid panel burning.
- » BG Gray: Select gray level on besides display picture
- » Power save Mode: DPMS (Display Power Management Signaling) Power Save Mode





## 12. Setup Menu Options continued

### 12-14. Screen Control



**Auto Calibration for qualified personnel ONLY**

Connect CA-210 or K-10 probe with RS-232 and executes an automatic screen regulation.

#### STEPS:

1. Set the baud rate of ca-210 to 9800.
2. Use RS-232 cable and connect to RS-232 in port.
3. Set full white pattern in SDI input
4. Press the password keys
5. Default password key. (Function3 key, Function2 key, Function1 key, down key)
6. Probe set position in yellow square box, and then start auto calibration as follow

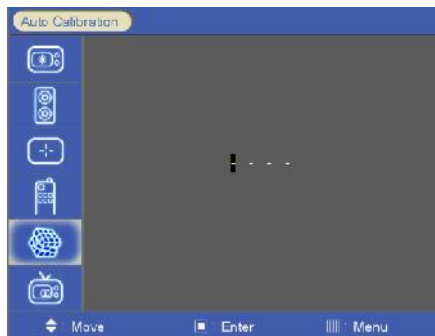

1) Press the password key.



2) Press 'SEL/INPUT' button to start auto calibration



3) Progress



4) Success

## 12. Setup Menu Options continued

---

### Screen Control continued

#### 5) Result messages are 'Not Prepared!!', 'fail!!' and 'Success!!'.

- » "not prepared!!" : cannot communication with CA-210 or K-10
- » "fail!!" : cannot search target LV or temp values.

#### Note:

- » target Lv ( full white is 100 cd/m2), color temperature(3000c~12000c)
- » if not succeed, values are restored as lately succeed values or factory default values.
- » continued fail, Backlight brightness should be adjust to other value.

#### Reset Calibration

- » calibration reset (factory default values or lately succeed values)
- » Password is same the auto calibration password.

#### Backlight Adjust

- » Inverter Backlight Level select (0~100)

#### Gamma Select

- » Gamma Level Select (0.8, 1.0, 1.1, 1.2, 1.5, 2.0)

#### Deinterlacer

- » Deinterlacer function on/off

#### Internal Pattern:

- » 100% color Bars, 75% color Bars, Luma, RGB, White, Black, red, Blue, Green

### 12-15. Fan Control

- » fan control: internal fan controls driving option by temperature sensor auto / force on / force off
- » fan active temperature: adjusts fan driving temperature by celsius degree. it works only when the fan control Setting is auto.
- » Hysteresis: adjusts fan driving hysteresis temperature by Celsius degree. (1~10 )
- » Shutdown: for a monitor protection is above of 75 , Power off.
- » MCU fan control: control main MCU fan on/off

### 12-16. X768 Mode

- » Selects X768 native Pc video timings. (auto/1024x/1280x/1360x/1366x)

## 12. Setup Menu Options continued

### 12-17. Caption

Closed caption: 608 Line21, 608 ANC, 608 Transcoded, 708 mode Select



608 caption mode Select. (c/c1, c/c2, c/c3, c/c4, text1, text2, text3, text4, off)  
708 caption model select (service 1, service 2)

### 12-18. Waveform format

Press the WAVEFORM button to display the WAVEFORM Mode

### 12-19. Y-Pb-Pr Waveform

Y\_Pb\_Pr WAVEFORM & Audio Lever Meter & info Window & time code Display.



### 12-20. Y-Waveform + Vector Scope

WAVEFORM & Vector Scope & Audio Lever Meter & info Window & time code Display.



## 12. Setup Menu Options continued

### 12-21. Double

SDI 1, 2 & WAVEFORM & Vector Scope & Audio Lever Meter & info Window & time code Display.



### 12-22. Y-Waveform + Vector Scope trans

WAVEFORM & Vector Scope trans.



### 12-23. Set Id & Active Set Id

For external control, monitor board has Set ID number range from (01~99).

Set active Set ID number prior RS-232 or remote control

i.e. To control monitor # 15, active Set ID must Set to 15.

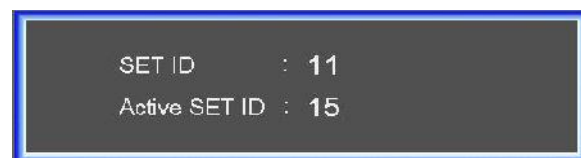

1. Press the BLUE (remote control) button and then use 0~9 button to select the active Set ID.
2. Press the RED (remote control) button to delete ID number.

## 13. PIP (Picture IN Picture)

- » Watch two programs or source at the same time. Set up PIP size and position.
- » only Dual Link model Select

### 13-1. PIP ON/Off

- » control PIP function on/off.



### 13-2. Input Source

- » PIP input Source can operate with different signal and type.
- » analog (composite1, 2, 3, Y.Pb.Pr, GBR, Pc) inputs + Digital (DVI, HDMI) + SDI (SDI1, SDI2) inputs
- » SDI + SDI input PIP
- » ex) AV + S-Video (X), DVI + SDI (o), Pc + DVI (o), SDI1+SDI2 (o)

### 13-3. Aspect Ratio

- » choose PIP size of Small/POP1/POP2



PIP Small



PIP1



POP2

### 13-4. Position

- » choose the PIP position on the each corner of the panel

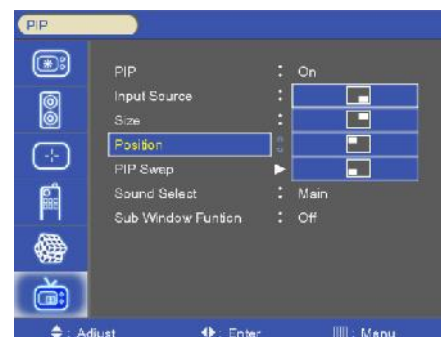



## 13. PIP (Picture IN Picture) continued

### 13-5. PIP Blend



-Blend to PIP size of Small

### 13-6. PIP Swap

- » using Swap option, you can exchange two programs or source at the same time.

### 13-7. Audio Select

- » using Sound Swap option, you can exchange the sound of two programs or source at the same time.

### 13-8. Sub Window function



Sub Window full



Sub Window Part

- » full Sub Window: Display the same full images on POP1 screen.
- » Part Sub Window: first image scale 4:3 aspect ratio and then display on POP2 screen.
- » full, Part function is only used in Digital input (SDI1, SDI2, DVI, HDMI)

## 14. Remote Control key Arrangements

---

- » IR remote control is applicable to all monitors size 32" and above



< Remote Control Picture >



## 14. Remote Control key Arrangements continued

### 14-1. IR-Remote Controller descriptions

Key Name	description
Power	Power on/off
Menu	Same as "Menu key" on keypad.
up	Same as "up key" on keypad
Down	Same as "Down key" on keypad
right	Same as "right key" on keypad
Left	Same as "Left key" on keypad
enter	Same as "Select key" on keypad
exit	exit OSD Menu
info	Displays input source information
Sleep	n/a
Mute	Toggles sound status of speaker/headphone in mute.
Source	Activates OSD of source change. Deactivates OSD of source change.
PSM(Picture Standard Mode)	Activates OSD of picture standard mode. Deactivates OSD of picture standard mode.
SSM(Sound Standard Mode)	Activates OSD of sound standard. Deactivates OSD of sound standard.
arc	Activates OSD of aspect ratio control. Deactivates OSD of aspect ratio control.
Still	Toggles picture status between motion and still image.
Pre_ch	n/a
Dual I-III / MTS	n/a
PIP	toggles PIP status
PIP input	change PIP input sources when PIP is on
PIP Size	change PIP image size when PIP is on
PIP Position	Change PIP position when PIP image size is not double screen.
SWAP	Swap main input source and PIP input source
S.Select	Select main/PIP sound source when PIP is on
Pc	Selects input source of Pc.
TV	n/a
0~9	enter digit value to active Set ID
BLUE	Set active Set ID
RED	Delete active Set ID
MIX	Activates Neptune OSD menu.
TTX on	n/a

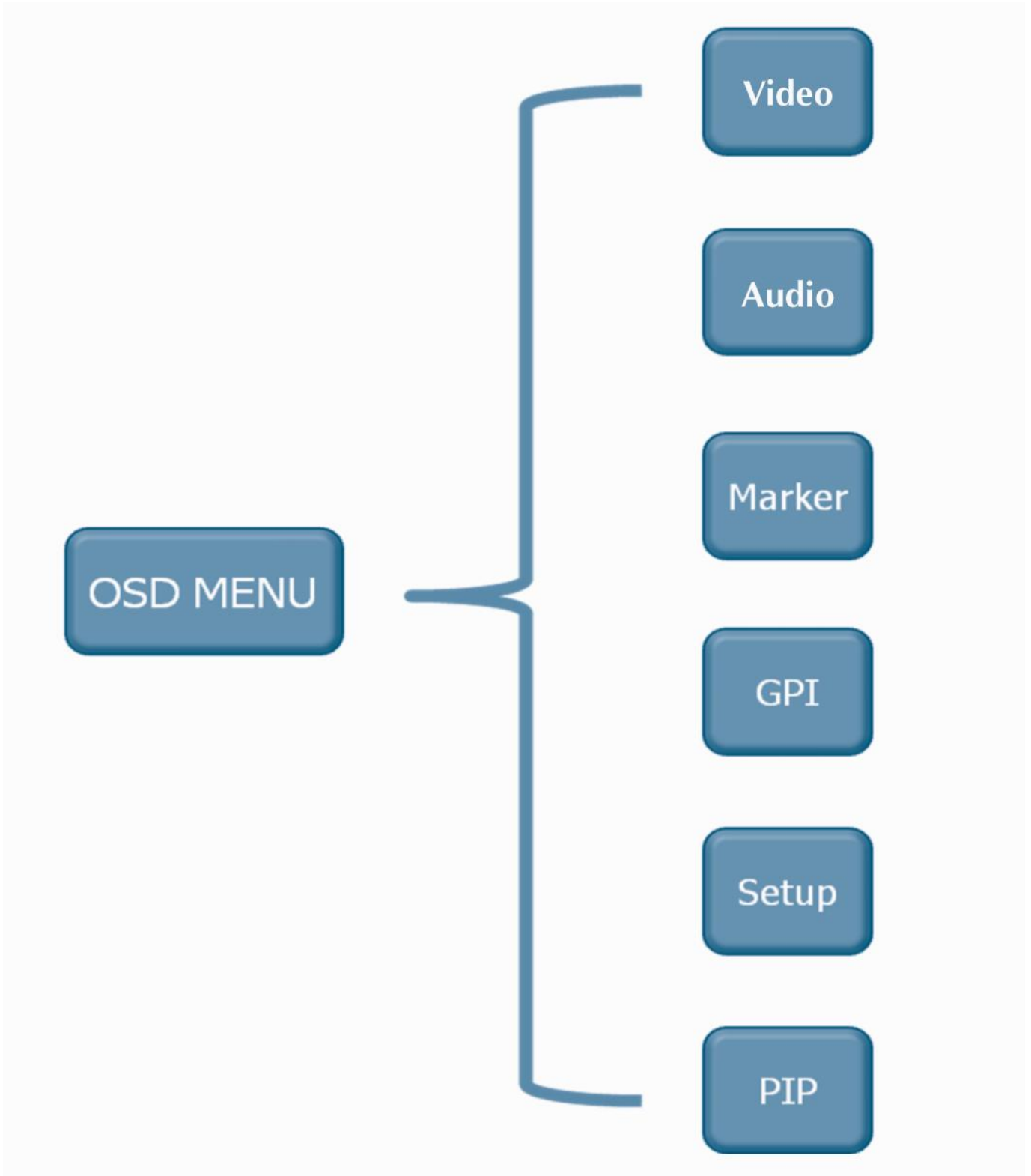

15-1. Video

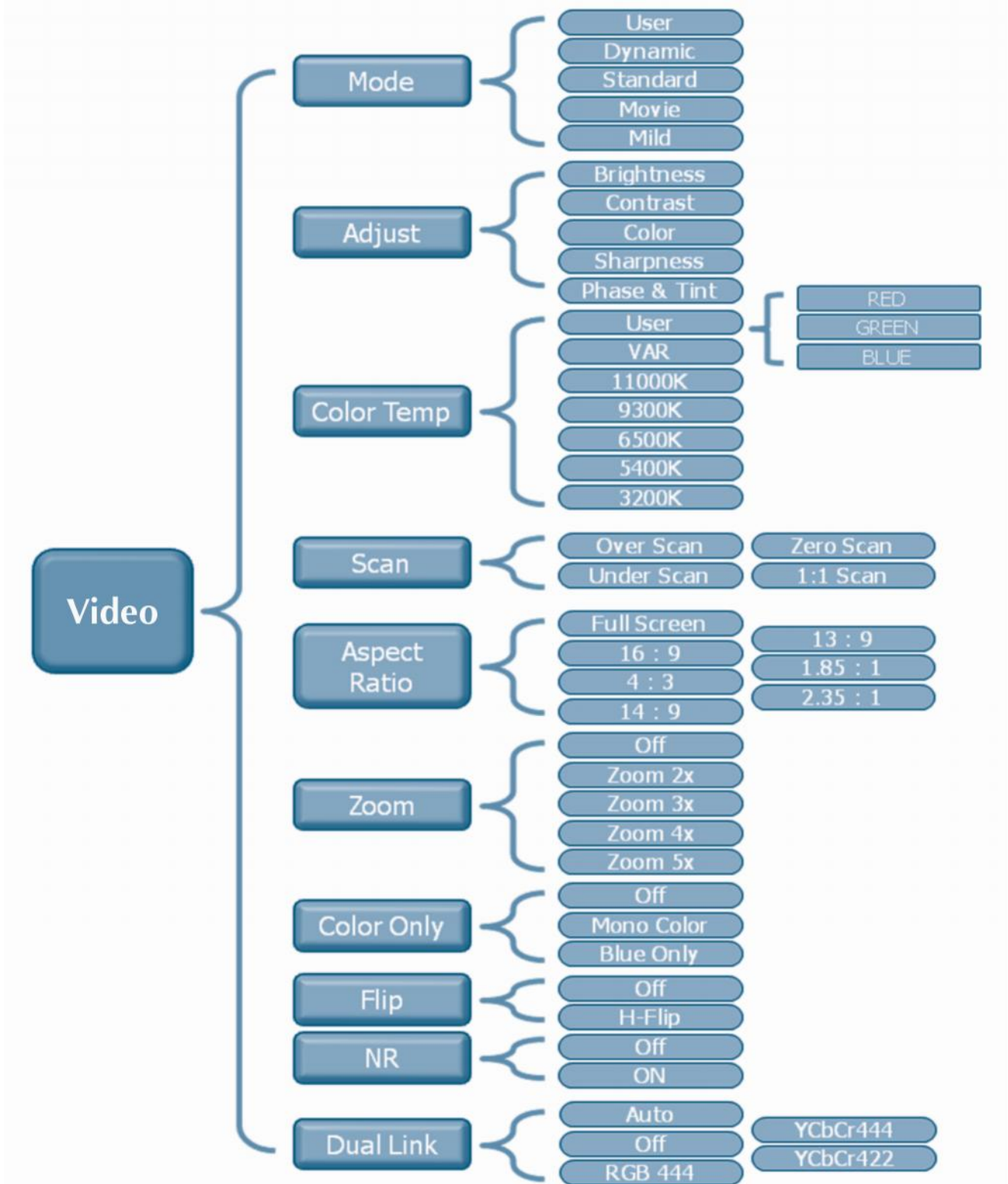

15-2. Audio

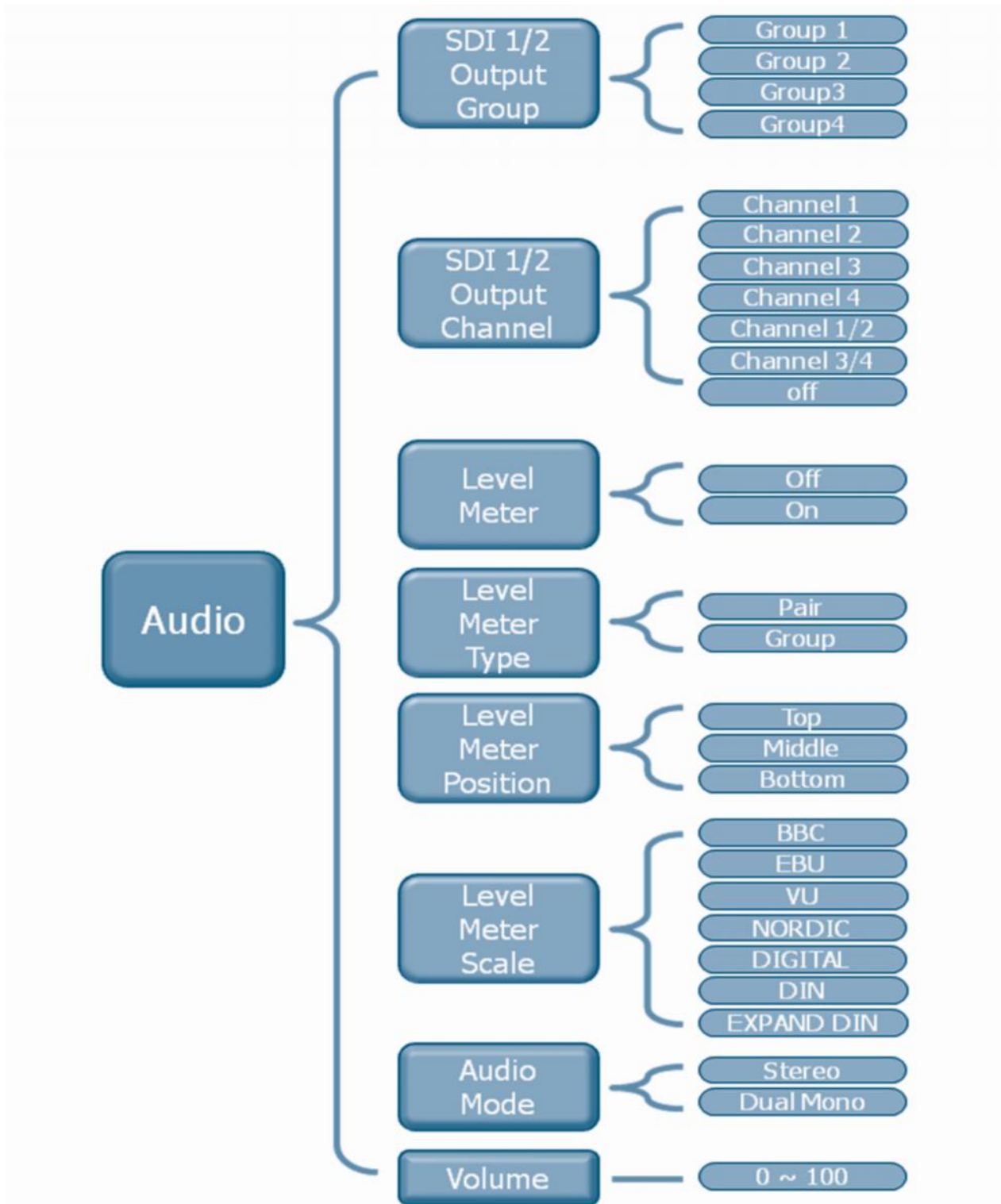

15-3. Marker

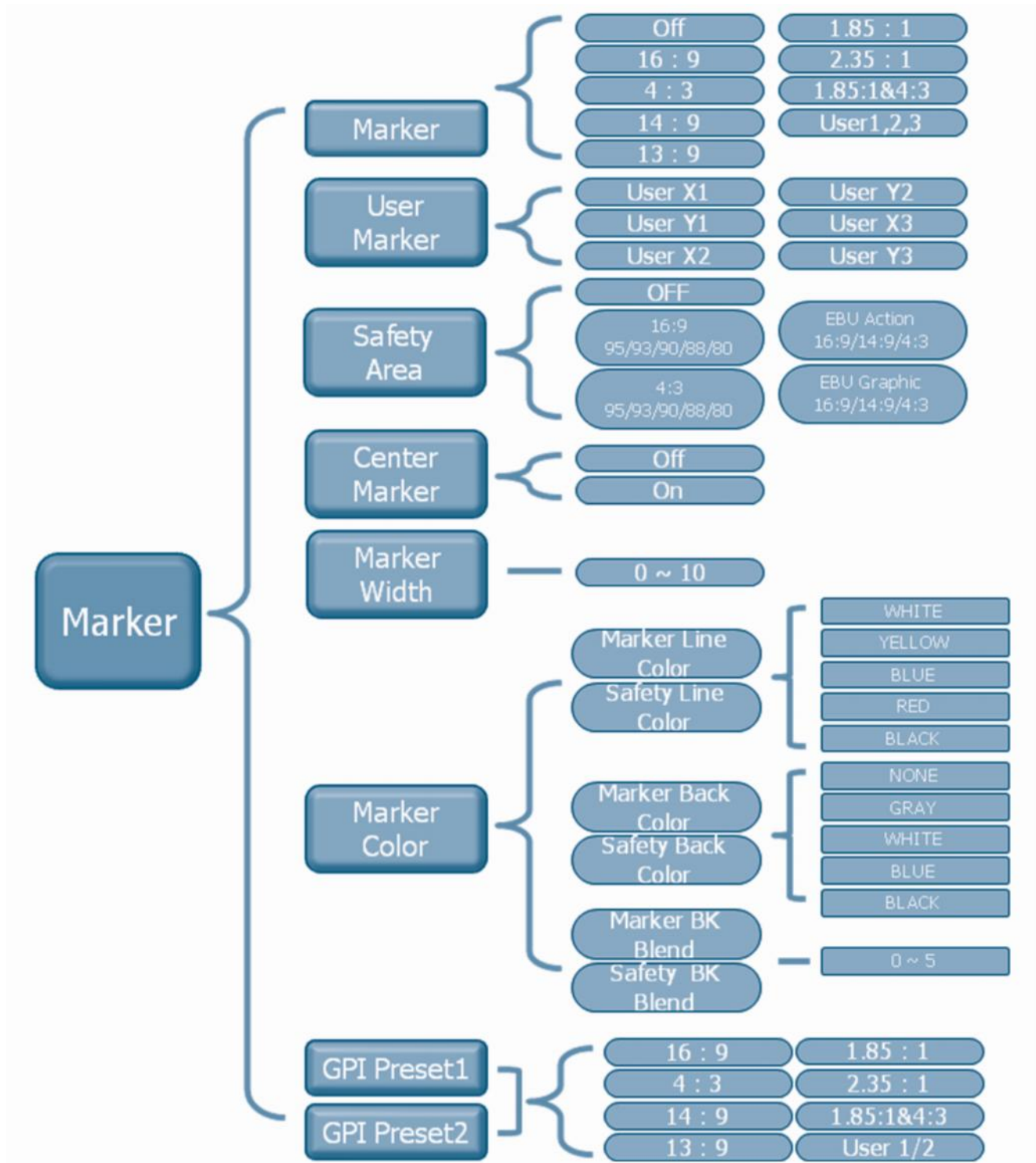

15-4. GPI

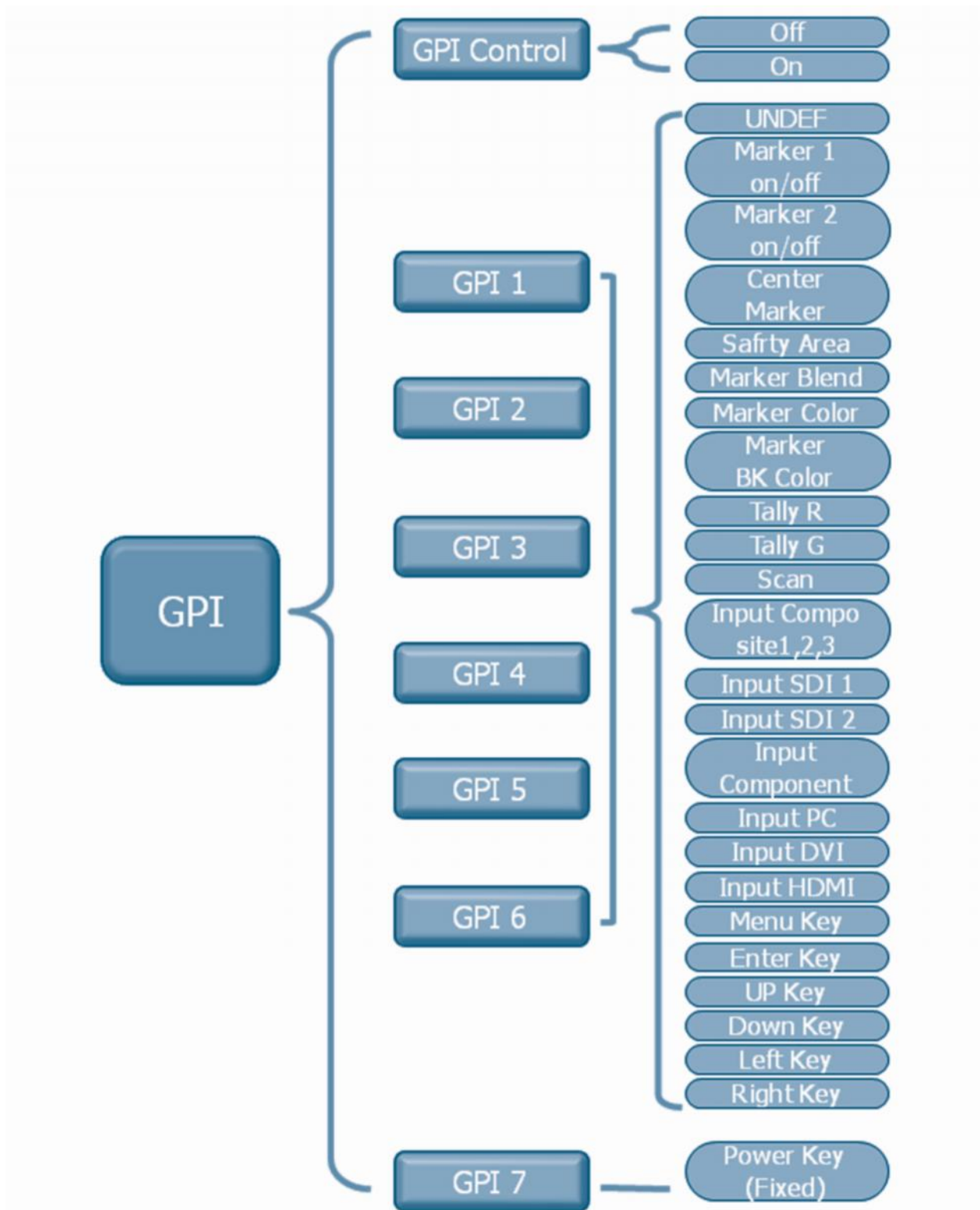



15-5. SETUP

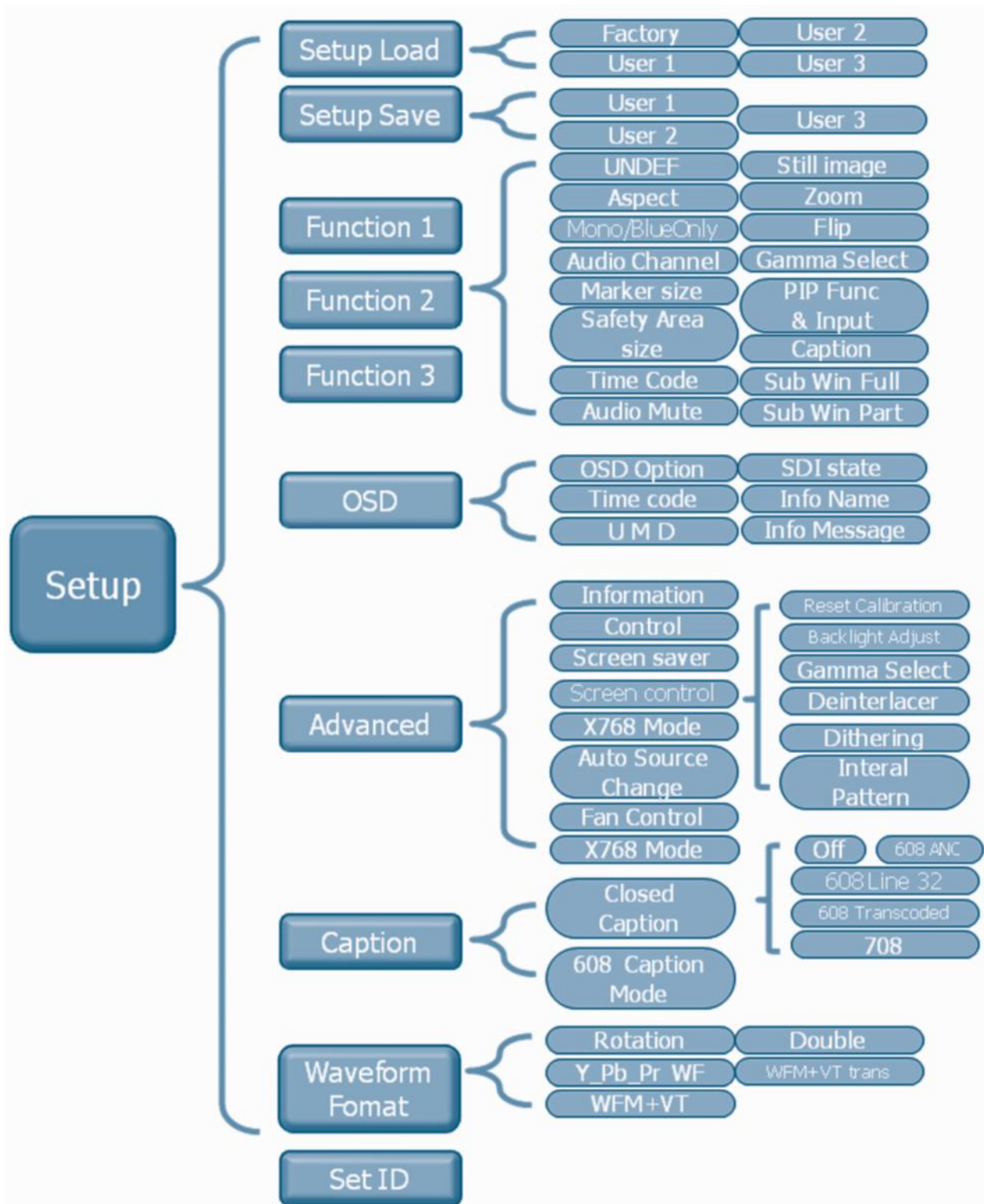



15-6. PIP

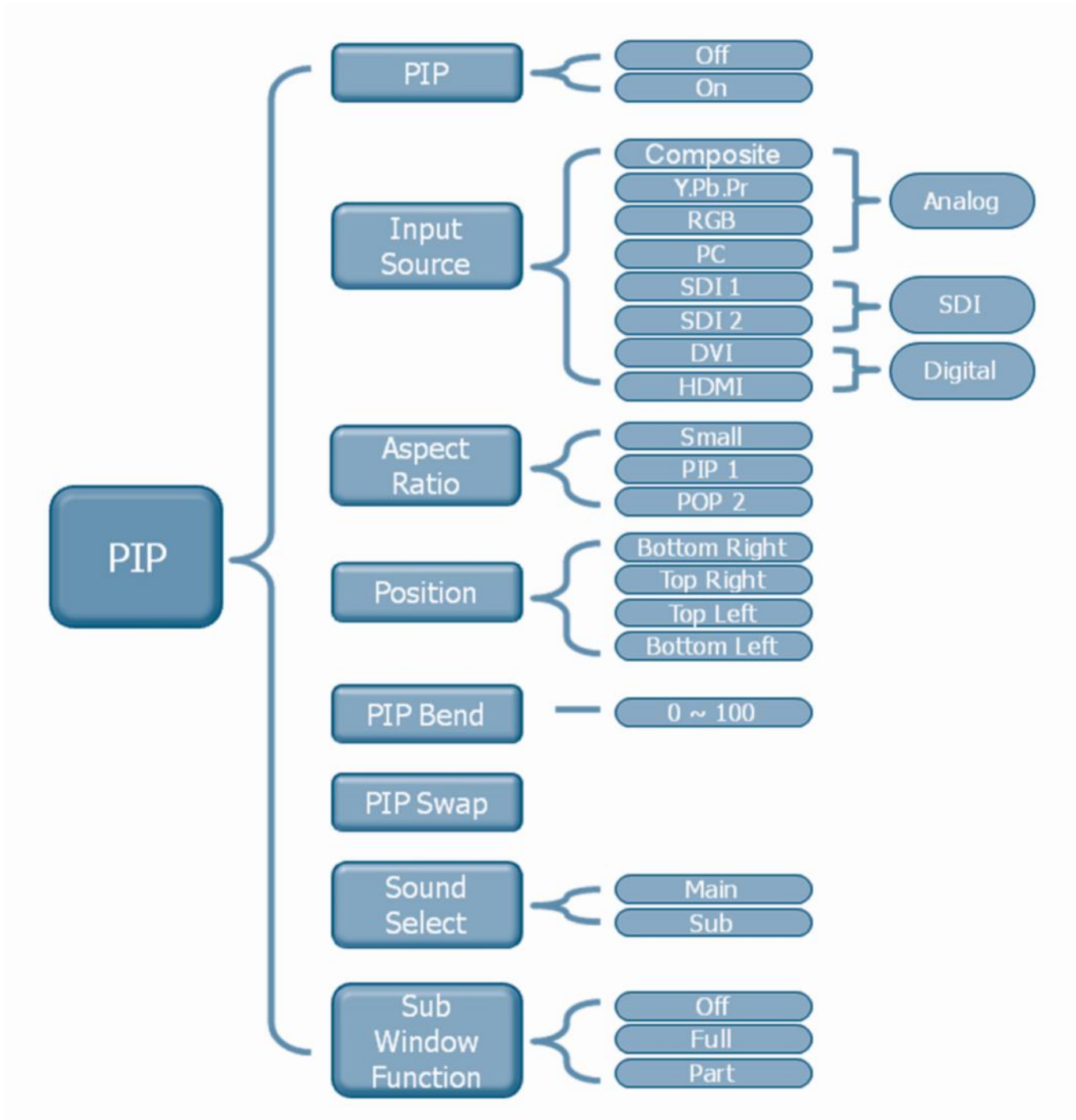

## 16. Supported Input Modes

### 16-1. Supported Signals

Items		Specifications
PBM-307-3G Display	Panel	7" TFT LCD
	Resolution	1024 horizontal. by 600 vertical.(contrast 900:1)
	Brightness	900 cd/m2
	Viewing angle	RL 178 (Typ), U/D 178 (Typ)
PBM-209-3G Display	Panel	9" TFT LCD
	Resolution	800 horizontal. by 480 vertical.(contrast 600:1)
	Brightness	600 cd/m2
	Viewing angle	RL 178 (Typ), U/D 178 (Typ)
PBM-317-3G Display	Panel	17" WXGA TFT LCD
	Resolution	1920 horizontal. by 1080 vertical.(contrast 900:1)
	Brightness	450 cd/m2
	Viewing angle	RL 178 (Typ), U/D 178 (Typ)
PBM-221-3G Display	Panel	21" TFT LCD
	Resolution	1920 horizontal. by 1080 vertical.(contrast 1000:1)
	Brightness	350 cd/m2
	Viewing angle	RL 178 (Typ), U/D 178 (Typ)
PBM-224-3G Display	Panel	24" TFT LCD
	Resolution	1920 horizontal. by 1200 vertical.(contrast 1000:1)
	Brightness	400 cd/m2
	Viewing angle	RL 178 (Typ), U/D 178 (Typ)
PBM-332-3G Display	Panel	32" TFT LCD
	Resolution	1920 horizontal. by 1080 vertical.(contrast 1000:1)
	Brightness	450 cd/m2
	Viewing angle	RL 178 (Typ), U/D 178 (Typ)
PBM-346-3G Display	Panel	46" TFT LCD
	Resolution	1920 horizontal. by 1080 vertical.(contrast 4000:1)
	Brightness	450 cd/m2
	Viewing angle	RL 178 (Typ), U/D 178 (Typ)
PBM-346-3G Display	Panel	47" TFT LCD
	Resolution	1920 horizontal. by 1080 vertical.(contrast 4000:1)
	Brightness	450 cd/m2
	Viewing angle	RL 178 (Typ), U/D 178 (Typ)
PBM-255-3G Display	Panel	55" TFT LCD
	Resolution	1920 horizontal. by 1080 vertical.(contrast 3000:1)
	Brightness	500 cd/m2
	Viewing angle	RL 178 (Typ), U/D 178 (Typ)
Supported Signals	Serial Digital interface	HD SDI- 2.970 Gb/s & 1.485 Gb/s
		SD SDI- 270 Mb/s
	HDMI DVI-I (DVI+VGA_IN)	H frequency range : 20~82 kHz
		V frequency range : 55 ~ 90 Hz
		Maximum resolution :1920x1080 60Hz
		Maximum pixel rate : 162 MHz
	ANALOG RGB	H frequency range : 20~82 kHz
		V frequency range : 55 ~ 90 Hz
		Maximum resolution : 1920x1080 60Hz
		Maximum pixel rate : 162 MHz
ANALOG Component (DTV/DVD)	DTV mode support: 720P/1080i/1080p	
	SOG sync support	
		1080p - 1080i - 720P -480i / 576i - 480P / 576P

## 16. Supported Input Modes continued

### 16-2. SDI input

SDI input			
SDI input	SMPTE-428.1M	2048x1080P(24/25)	
Signal formats	SMPTE-425M(3G)	1920x1080P(50/60)	
	SMPTE-260M	1920x1035i(60/59.94)	
	SMPTE-259M	1920x1080i(50)	
	SMPTE-274M	1920x1080i (50/59.94/60)	1920x1080P (30Psf/25Psf/24Psf/30/25/24)
			1280x720P (24/25/30/50/59.94/60)
	SMPTE-125M	480i(59.94)	
	ITU-R BT.601	576i(50)	

### 16-3. DVI & PC input

Section	Resolution	h frequency ( khz )	V frequency ( hz )	Pixel frequency ( Mhz )	Comment
DTV	720x480	15.735	59.94	13.500	Interlaced
	720x576	15.735	50.0	13.595	Interlaced
	720x480	31.469	59.94	25.175	
	720x576	31.250	50.0	26.566	
	1280x720	44.964	59.94	74.176	
	1280x720	37.500	50.0	60.466	
	1920x1080	33.750	60.0	74.25	Interlaced
	1920x1080	28.125	50.0	70.723	Interlaced
	1920x1080	31.250	50.0	72.000	Interlaced
	1920x1080	67.5	60	148.5	Progressive

Section	Resolution	h frequency ( khz )	V frequency ( hz )	Pixel frequency ( Mhz )	Comment
PC	640x400	37.861	85.08	31.5	
	640x350	31.469	70.087	25.175	
	640x350	37.861	85.08	31.5	
	640x480	31.469	59.94	25.175	
	640x480	35.000	66.667	30.24	
	640x480	34.940	69.884	28.513	
	640x480	37.861	72.809	29.765	
	640x480	37.500	75.0	31.5	
	640x480	43.269	85.008	36.0	
	640x480	45.540	90.0	37.889	
	720x400	31.469	70.087	28.322	
	720x400	37.927	85.039	35.5	
	800x600	35.156	56.25	36.0	
	800x600	37.879	60.317	40.0	
	800x600	43.764	70.02	45.513	
	800x600	48.077	72.188	50.0	
	800x600	46.875	75.0	49.5	
	800x600	53.674	85.061	56.25	
	800x600	56.880	90.0	60.065	
	832x624	49.726	74.551	57.284	
	1024x768	48.780	60.001	64.11	
	1024x768	48.363	60.004	65.0	
	1024x768	56.476	70.069	75.0	
	1024x768	57.703	72.039	78.476	
	1024x768	60.241	74.927	81.724	
	1024x768	60.030	75.029	78.75	
	1024x768	68.677	84.997	94.5	
	1024x768	72.810	90.0	100.187	
	1152x864	53.700	60.0	81.624	
	1152x864	62.932	69.924	96.663	
	1152x864	67.500	75.0	104.993	
	1152x870	68.681	75.062	100.0	
	1152x900	61.846	66.0	94.787	
	1152x900	72.713	76.047	105.561	
	1280x720	47.760	60.0	74.481	
	1280x720	52.500	70.0	89.040	
	1280x720	54.072	72.0	91.706	
	1280x720	56.400	75.0	95.654	
	1280x768	60.150	75.0	102.977	
	1280x960	60.000	60.0	102.104	
	1280x960	59.640	60.0	102.104	
	1280x1024	63.337	59.978	108.18	
	1280x1024	63.981	60.02	108.0	
	1280x1024	64.754	60.06	108.992	
	1280x1024	63.600	60.0	108.883	
1360x768	47.700	60.0	84.700		
1600x1200	75.000	60.0	162.000		

## 17. Mechanical Dimension continued

### 17-1. PBM-307-3G

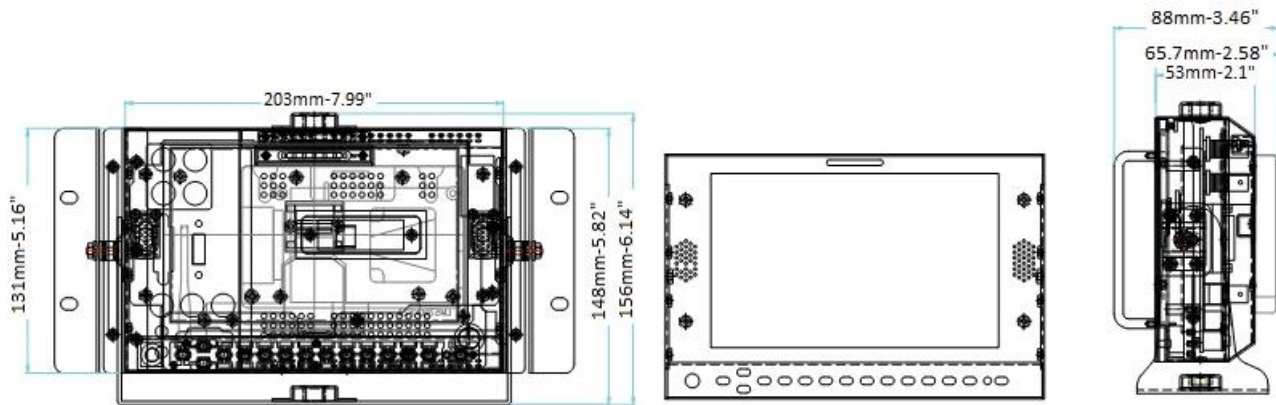

### 17-2. PBM-209-3G

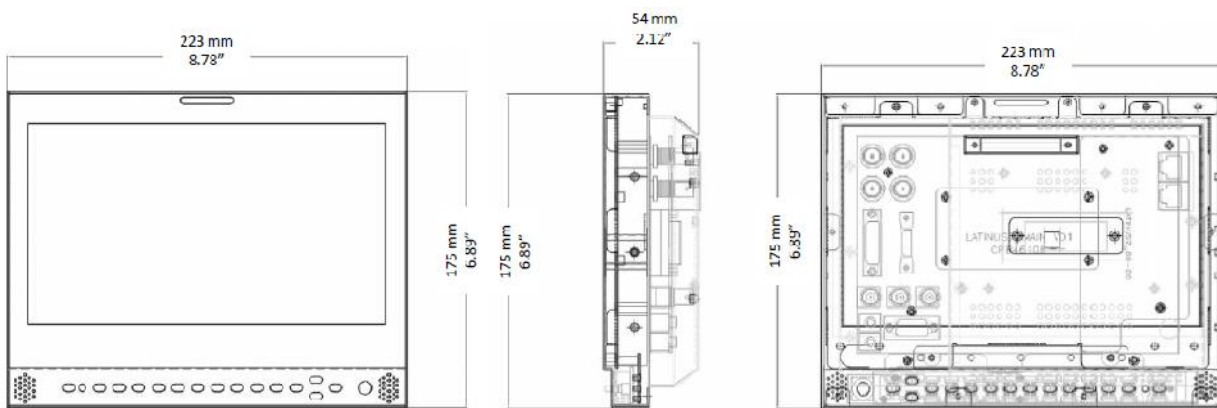

### 17-3. PBM-310-3G

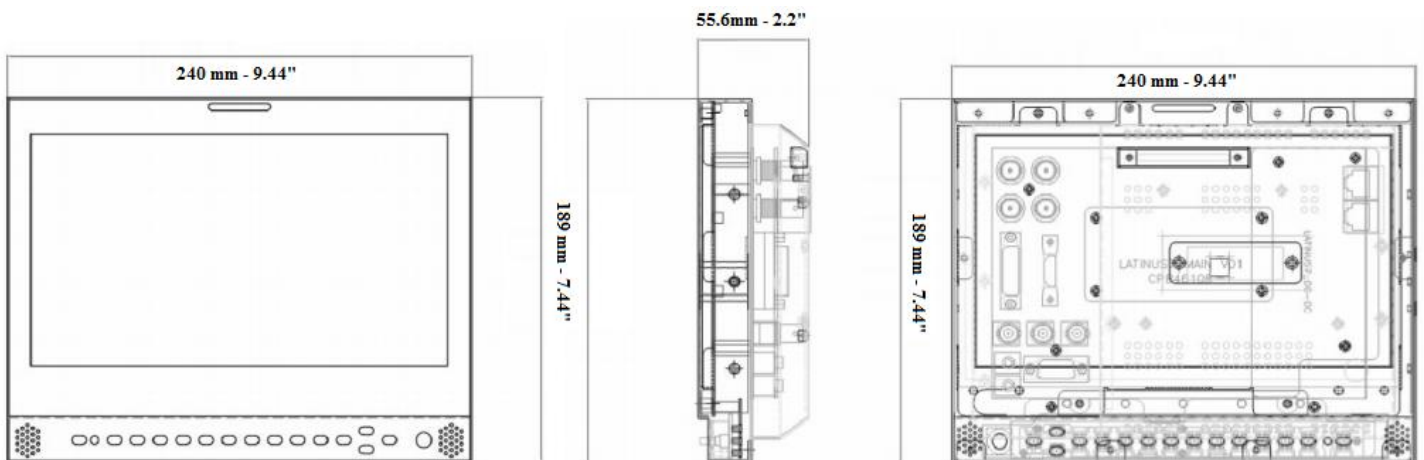

## 17. Mechanical Dimension continued

### 17-4. PBM-317-3G & PBM-217-3G

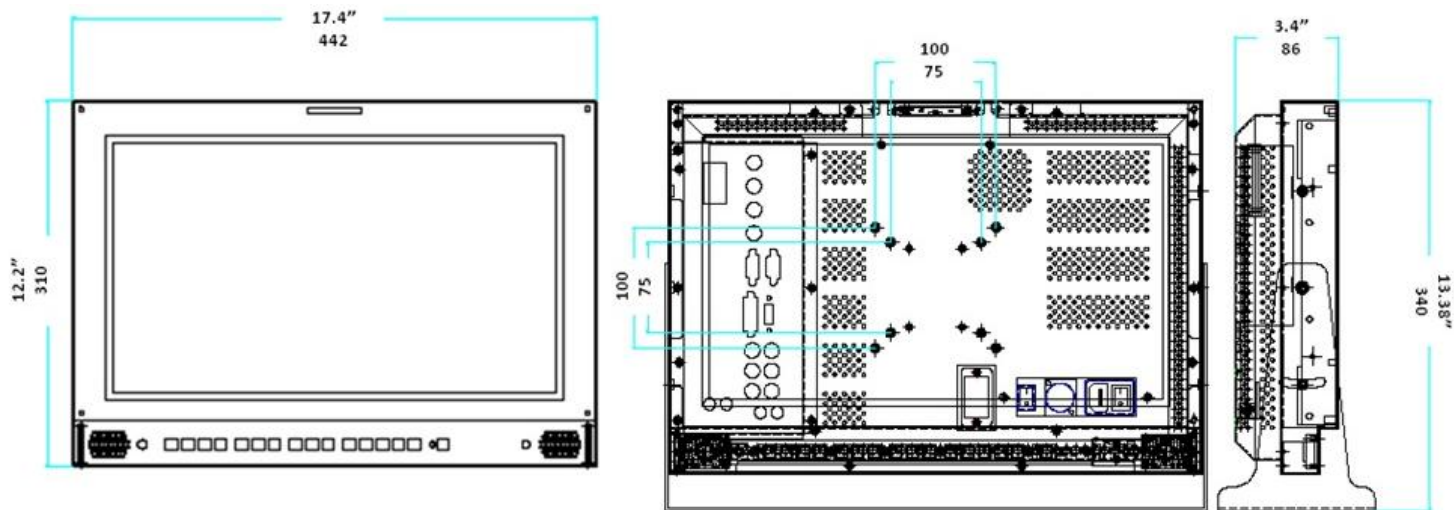

### 17-5. PBM-220-3G

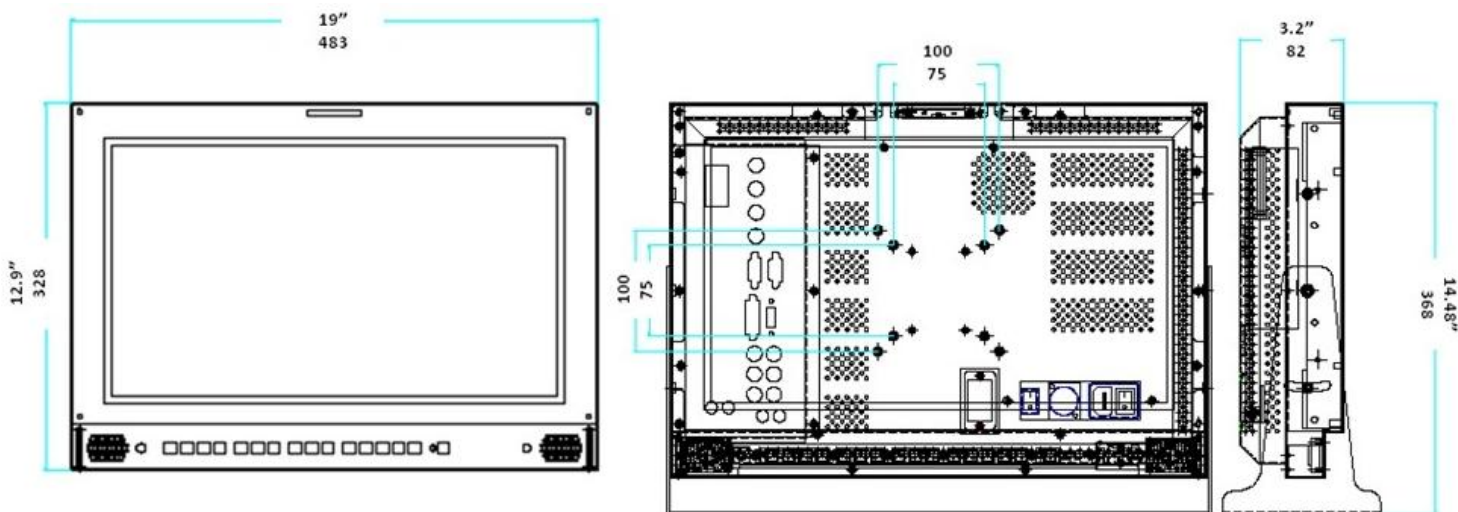

### 17-6. PBM-221-3G

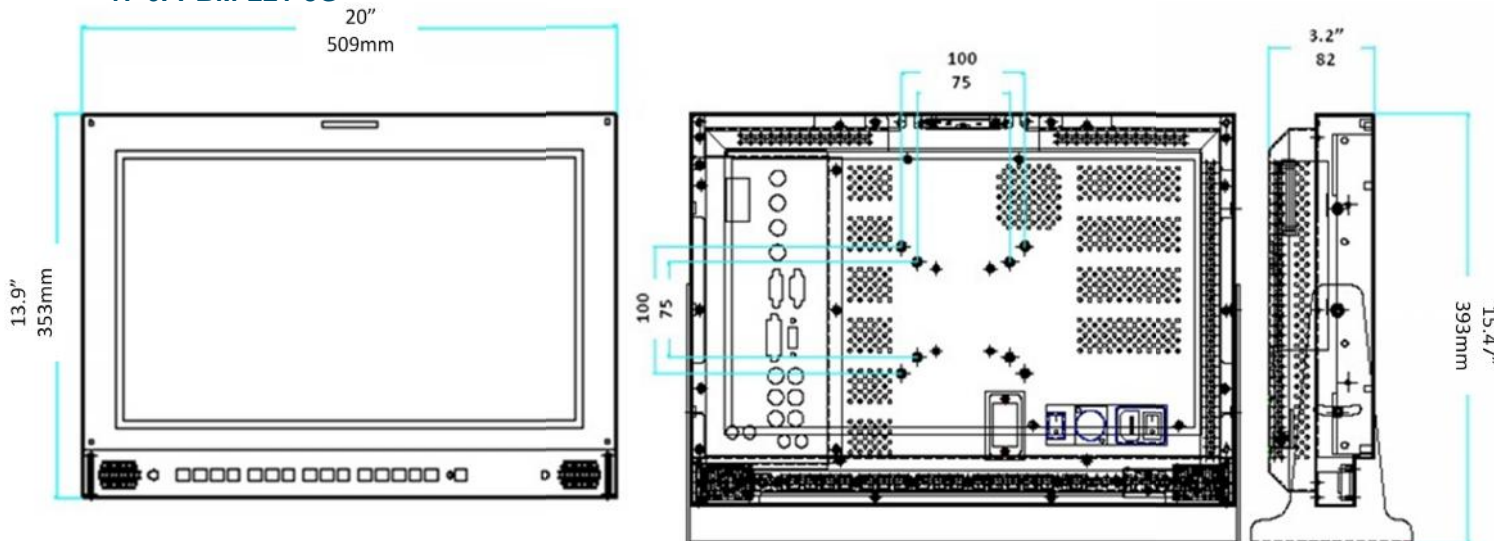



## 17. Mechanical Dimension continued

17-7. PBM-224-3G

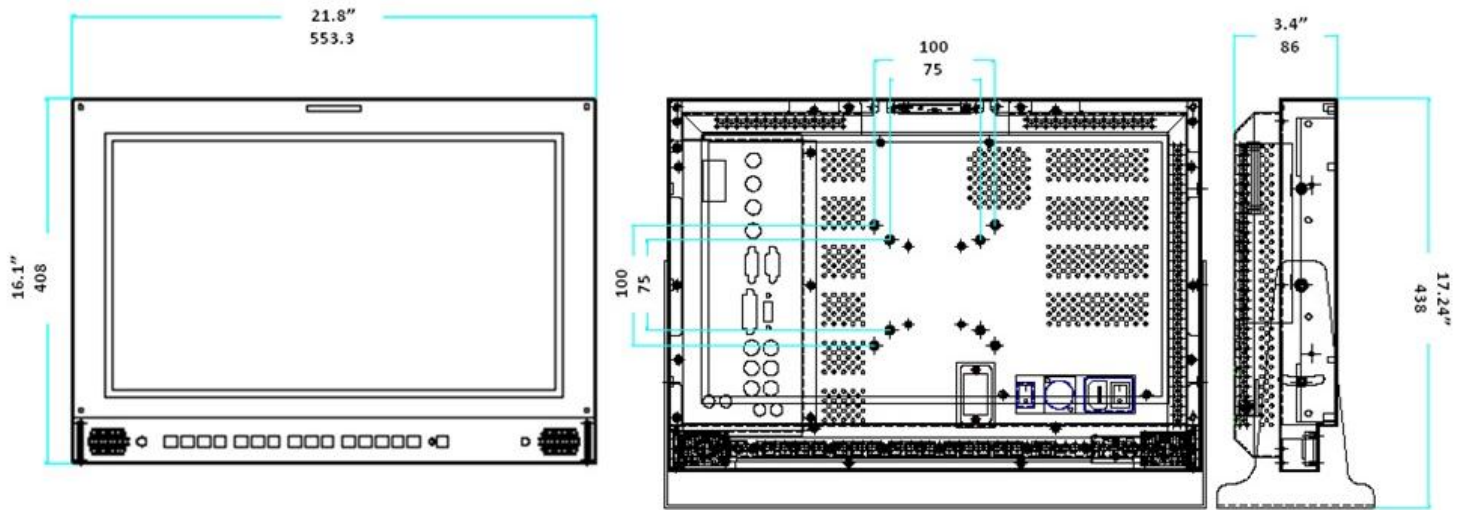

17-8. PBM-232-3G

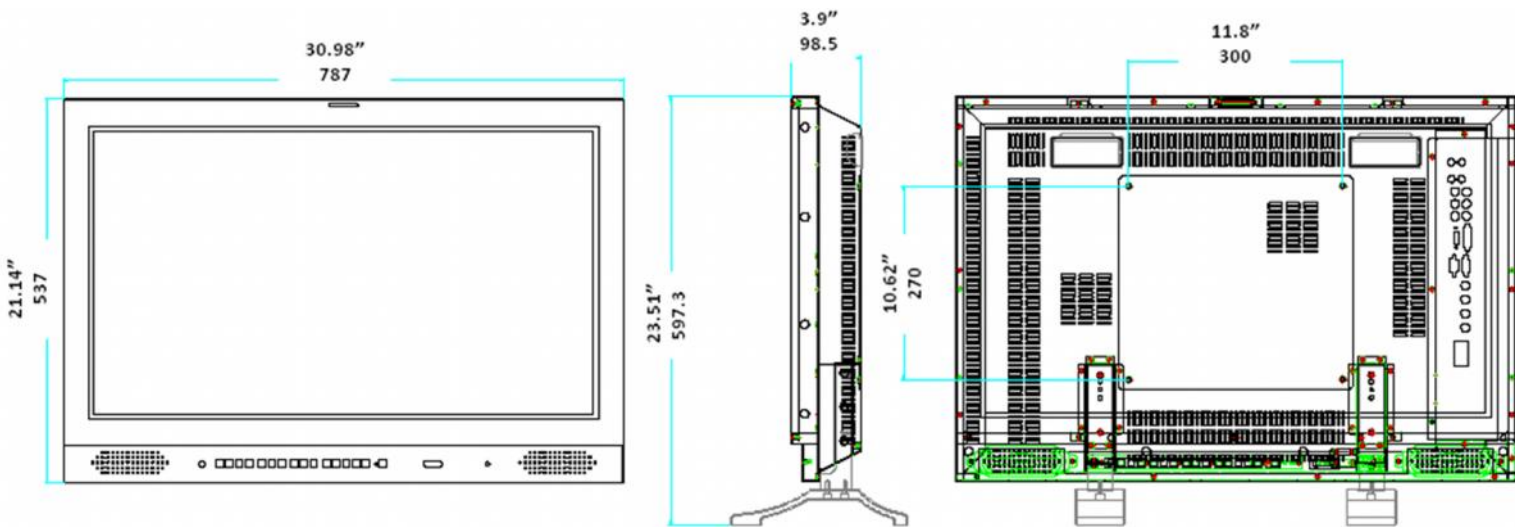

17-9. PBM-332-3G

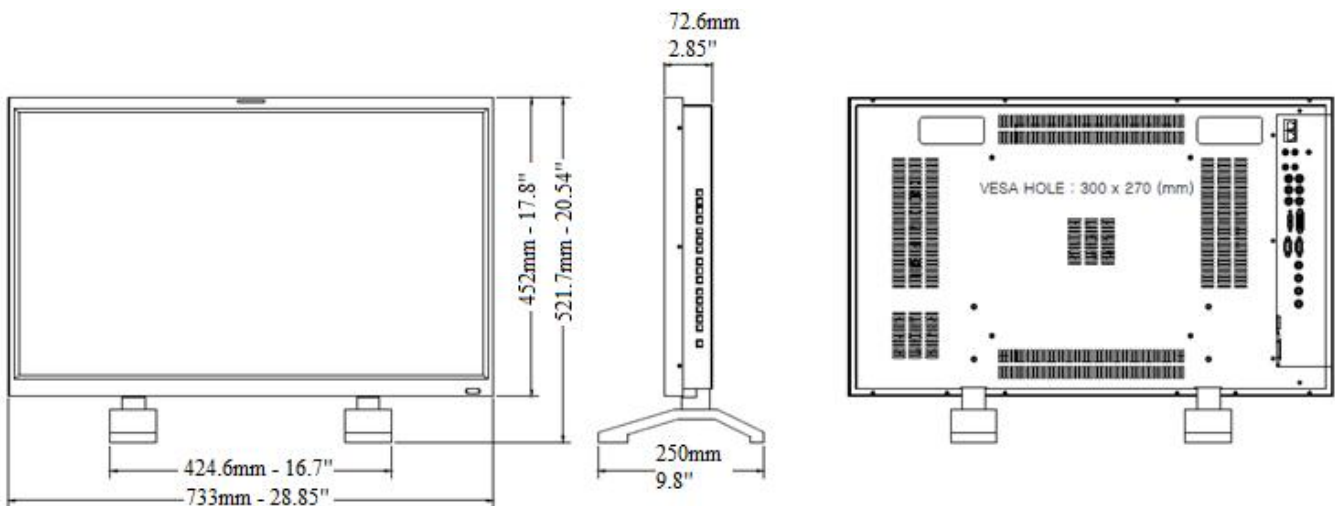



## 17. Mechanical Dimension continued

### 17-10. PBM-240-3G

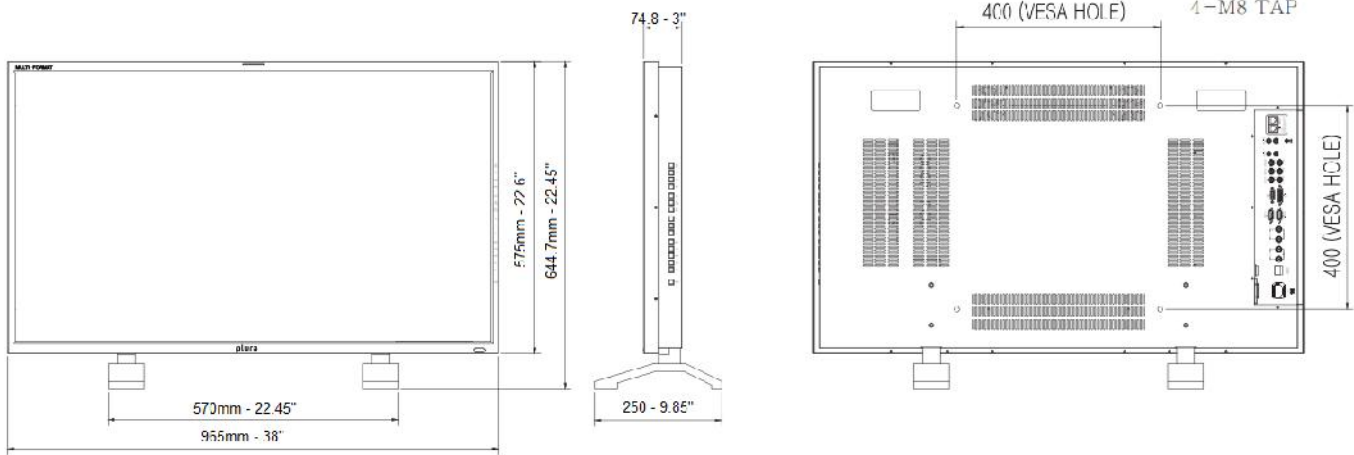

### 17-11. PBM-246-3G

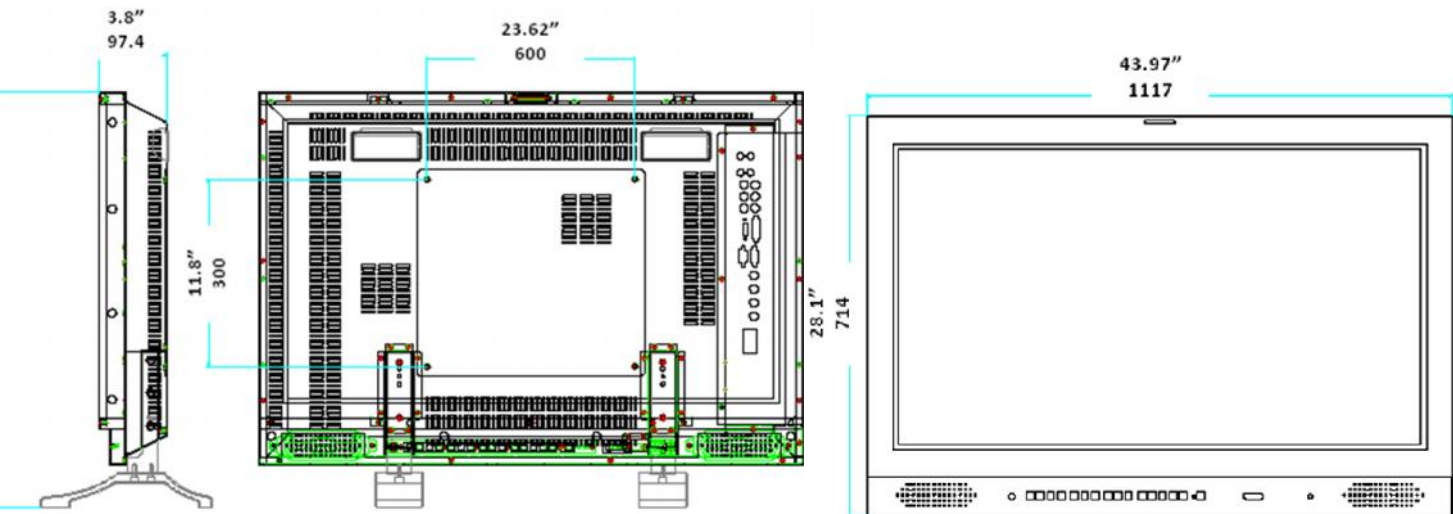

### 17-12. PBM-346-3G

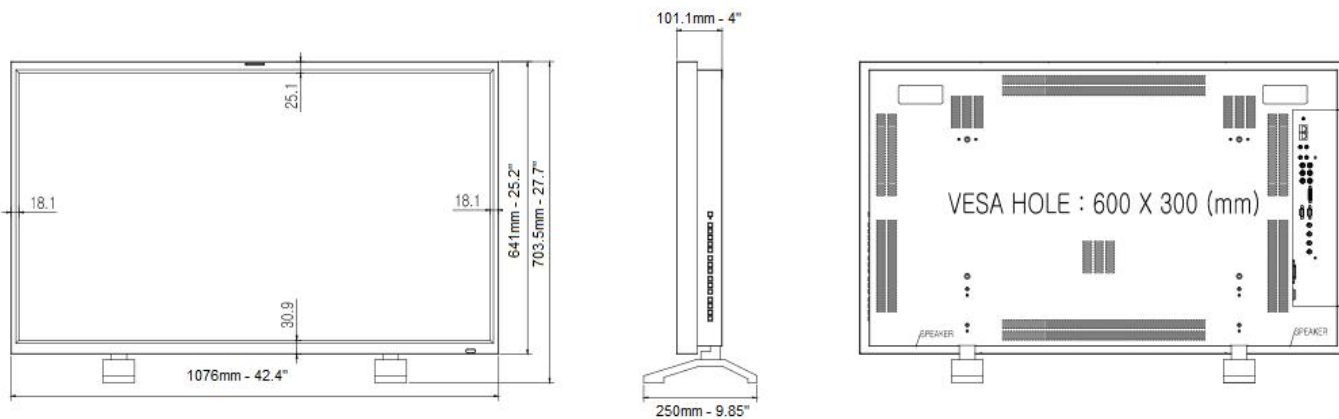

## 17. Mechanical Dimension continued

### 17-13. PBM-347-3G

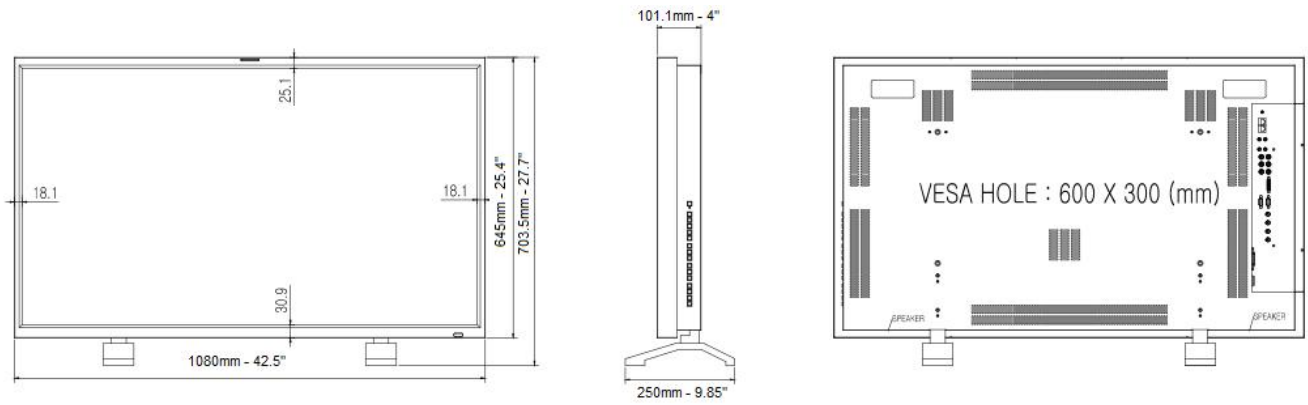

### 17-14. PBM-255-3G

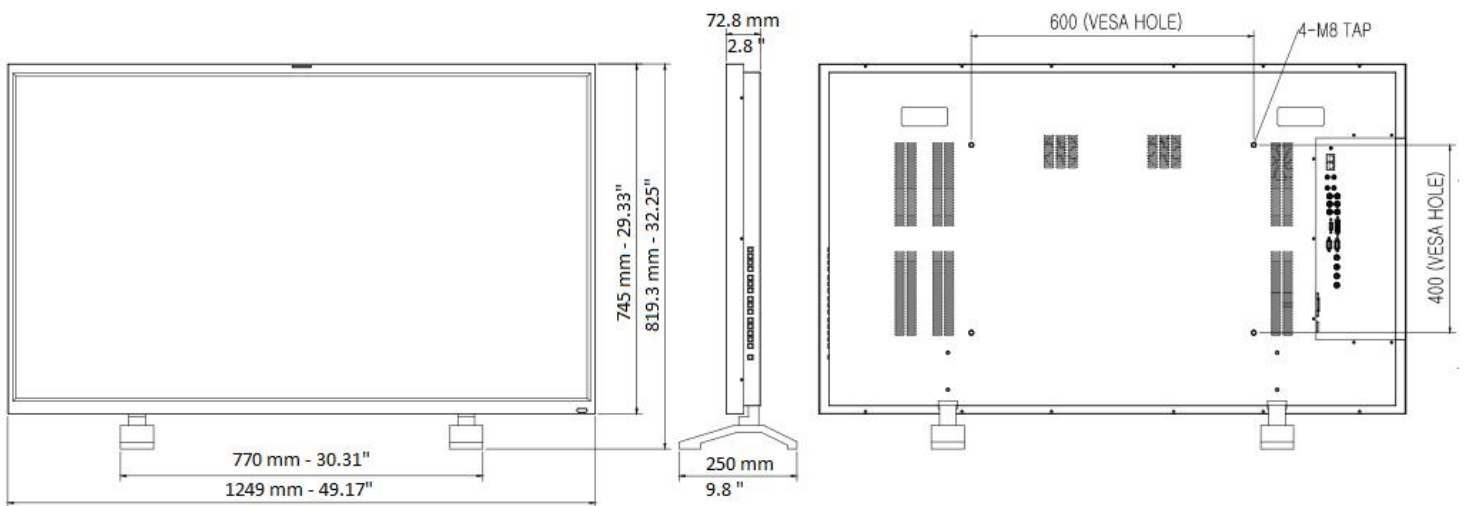

### 17-15. PBM-265-3G

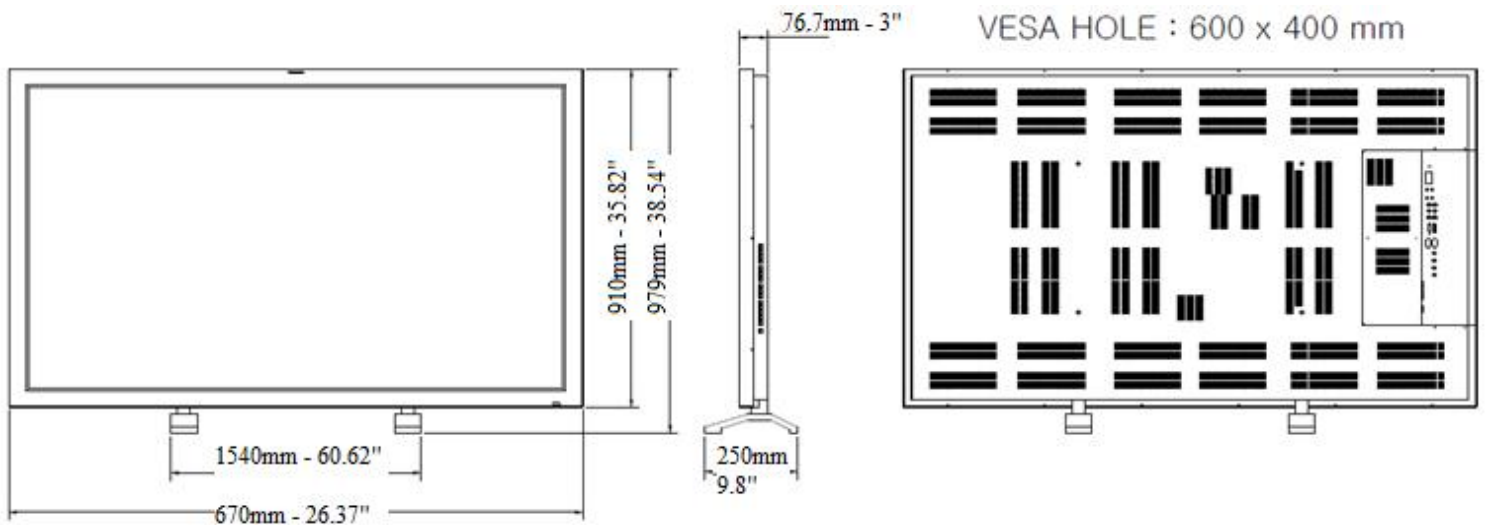

## 17. Mechanical Dimension continued

### 17-16. PBM-270-3G

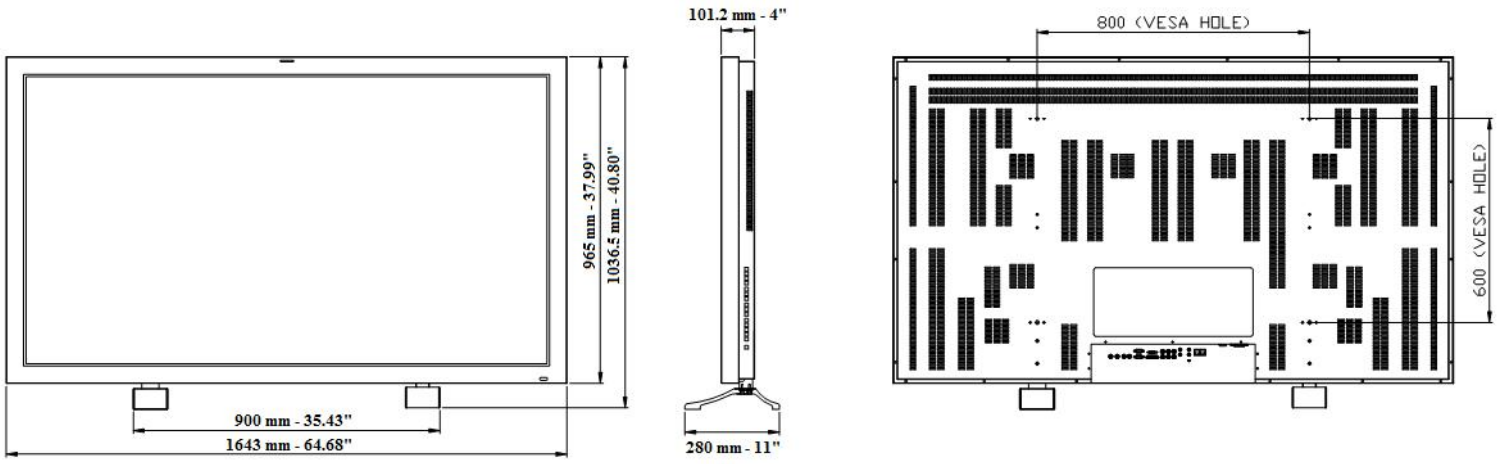

# plura<sup>®</sup>

[www.plurabroadcast.com](http://www.plurabroadcast.com)

**Plura Broadcast, Inc. - West Coast**

1930 W. Quail Ave  
Phoenix, AZ 85027  
Tel: (602) 944-1044  
Fax: (602) 324-9688

**Plura Broadcast, Inc. - East Coast**

67 Grand avenue  
Massapequa, NY 1175  
Tel: (516) 997-5675  
Fax: (516) 593-7900