

# Roland

## VC-1-DL VIDEO CONVERTER

### Owner's Manual

Before using this unit, carefully read the sections entitled "USING THE UNIT SAFELY" (p. 3) and "IMPORTANT NOTES" (p. 7). These sections provide important information concerning the proper operation of the unit. Additionally, in order to feel assured that you have gained a good grasp of every feature of your new unit, owner's manual should be read in its entirety. This manual should be saved and kept on hand as a convenient reference.



### FS Delay

Copyright © 2013 ROLAND CORPORATION

All rights reserved. No part of this publication may be reproduced in any form without the written permission of ROLAND CORPORATION.

- \* Roland is either registered trademark or trademark of Roland Corporation in the United States and/or other countries.
- \* All product names mentioned in this document are trademarks or registered trademarks of their respective owners.

For the U.K.

**IMPORTANT:** THE WIRES IN THIS MAINS LEAD ARE COLOURED IN ACCORDANCE WITH THE FOLLOWING CODE.

BLUE: NEUTRAL  
BROWN: LIVE

As the colours of the wires in the mains lead of this apparatus may not correspond with the coloured markings identifying the terminals in your plug, proceed as follows:

The wire which is coloured BLUE must be connected to the terminal which is marked with the letter N or coloured BLACK.

The wire which is coloured BROWN must be connected to the terminal which is marked with the letter L or coloured RED.

Under no circumstances must either of the above wires be connected to the earth terminal of a three pin plug.

# USING THE UNIT SAFELY

## INSTRUCTIONS FOR THE PREVENTION OF FIRE, ELECTRIC SHOCK, OR INJURY TO PERSONS

About ⚠ WARNING and ⚠ CAUTION Notices

<b>⚠ WARNING</b>	Used for instructions intended to alert the user to the risk of death or severe injury should the unit be used improperly.
<b>⚠ CAUTION</b>	Used for instructions intended to alert the user to the risk of injury or material damage should the unit be used improperly. * Material damage refers to damage or other adverse effects caused with respect to the home and all its furnishings, as well to domestic animals or pets.

About the Symbols

<b>⚠</b>	The ⚠ symbol alerts the user to important instructions or warnings. The specific meaning of the symbol is determined by the design contained within the triangle. In the case of the symbol at left, it is used for general cautions, warnings, or alerts to danger.
<b>⊘</b>	The ⊘ symbol alerts the user to items that must never be carried out (are forbidden). The specific thing that must not be done is indicated by the design contained within the circle. In the case of the symbol at left, it means that the unit must never be disassembled.
<b>⦿</b>	The ● symbol alerts the user to things that must be carried out. The specific thing that must be done is indicated by the design contained within the circle. In the case of the symbol at left, it means that the power-plug must be unplugged from the outlet.

### ALWAYS OBSERVE THE FOLLOWING

#### **⚠ WARNING**

**To completely turn off power to the unit, pull out the plug from the outlet**



- When the power needs to be turned off, pull out the plug from the outlet. For this reason, the outlet into which you choose to connect the power cord's plug should be one that is within easy reach and readily accessible.

#### **⚠ WARNING**

**Do not repair or replace parts by yourself**



- Do not attempt to repair the unit, or replace parts within it (except when this manual provides specific instructions directing you to do so). Refer all servicing to your retailer, the nearest Roland Service Center, or an authorized Roland distributor, as listed on the "Information" sheet.

**Concerning the Auto Off function**



- The power to this unit will be turned off automatically after a predetermined amount of time has passed since the last input of signal (AUTO OFF function). If you do not want the power to be turned off automatically, disengage the AUTO OFF function (p. 13).

**Do not disassemble or modify by yourself**



- Do not open (or modify in any way) the unit or its AC adaptor.

**Do not use or store in the following types of locations**



- Subject to temperature extremes (e.g., direct sunlight in an enclosed vehicle, near a heating duct, on top of heat-generating equipment); or are
- Damp (e.g., baths, washrooms, on wet floors); or are
- Exposed to steam or smoke; or are
- Subject to salt exposure; or are
- Humid; or are
- Exposed to rain; or are
- Dusty or sandy; or are
- Subject to high levels of vibration and shakiness.

 **WARNING**

**Do not place in an unstable location**



- Make sure you always have the unit placed so it is level and sure to remain stable. Never place it on stands that could wobble, or on inclined surfaces.
- 

**Use only the supplied AC adaptor and the correct voltage**



- Be sure to use only the AC adaptor supplied with the unit. Also, make sure the line voltage at the installation matches the input voltage specified on the AC adaptor's body. Other AC adaptors may use a different polarity, or be designed for a different voltage, so their use could result in damage, malfunction, or electric shock.
- 

**Use only the supplied power cord**



- Use only the attached power-supply cord. Also, the supplied power cord must not be used with any other device.
- 

**Do not bend the power cord or place heavy objects on it**



- Do not excessively twist or bend the power cord, nor place heavy objects on it. Doing so can damage the cord, producing severed elements and short circuits. Damaged cords are fire and shock hazards!
- 

 **WARNING**

**Avoid extended use at high volume**



- This unit, either alone or in combination with an amplifier and headphones or speakers, may be capable of producing sound levels that could cause permanent hearing loss. Do not operate for a long period of time at a high volume level, or at a level that is uncomfortable. If you experience any hearing loss or ringing in the ears, you should immediately stop using the unit, and consult an audiologist.
- 

**Don't allow foreign objects or liquids to enter unit; never place containers with liquid on unit**



- Do not place containers containing liquid (e.g., flower vases) on this product. Never allow foreign objects (e.g., flammable objects, coins, wires) or liquids (e.g., water or juice) to enter this product. Doing so may cause short circuits, faulty operation, or other malfunctions.
-

**! WARNING**

**Turn off the unit if an abnormality or malfunction occurs**



- Immediately remove the AC adaptor from the outlet, and request servicing by your retailer, the nearest Roland Service Center, or an authorized Roland distributor, as listed on the "Information" sheet when:
  - The AC adaptor, the power-supply cord, or the plug has been damaged; or
  - If smoke or unusual odor occurs; or
  - Objects have fallen into, or liquid has been spilled onto the unit; or
  - The unit has been exposed to rain (or otherwise has become wet); or
  - The unit does not appear to operate normally or exhibits a marked change in performance.

**Adults must provide supervision in places where children are present**



- When using the unit in locations where children are present, be careful so no mishandling of the unit can take place. An adult should always be on hand to provide supervision and guidance.

**Do not drop or subject to strong impact**



- Protect the unit from strong impact. (Do not drop it!)

**! WARNING**

**Do not share an outlet with an unreasonable number of other devices**



- Do not force the unit's power-supply cord to share an outlet with an unreasonable number of other devices. Be especially careful when using extension cords - the total power used by all devices you have connected to the extension cord's outlet must never exceed the power rating (watts/amperes) for the extension cord. Excessive loads can cause the insulation on the cord to heat up and eventually melt through.

**Do not use overseas**



- Before using the unit in overseas, consult with your retailer, the nearest Roland Service Center, or an authorized Roland distributor, as listed on the "Information" sheet.

**! CAUTION**

**Place in a well ventilated location**



- The unit and the AC adaptor should be located so their location or position does not interfere with their proper ventilation.

**When disconnecting an AC adaptor, grasp it by the plug**



- To prevent conductor damage, always grasp the AC adaptor by its plug when disconnecting it from this unit or from a power outlet.

 **CAUTION**

**Periodically clean the AC adaptor's plug**



- At regular intervals, you should unplug the AC adaptor and clean it by using a dry cloth to wipe all dust and other accumulations away from its prongs. Also, disconnect the power plug from the power outlet whenever the unit is to remain unused for an extended period of time. Any accumulation of dust between the power plug and the power outlet can result in poor insulation and lead to fire.

**Manage cables for safety**



- Try to prevent cords and cables from becoming entangled. Also, all cords and cables should be placed so they are out of the reach of children.

**Avoid climbing on top of the unit, or placing heavy objects on it**



- Never climb on top of, nor place heavy objects on the unit.

**Do not connect or disconnect the AC adaptor with wet hands**



- Never handle the AC adaptor or its plugs with wet hands when plugging into, or unplugging from, an outlet or this unit.

**Disconnect everything before moving the unit**



- Before moving the unit, disconnect the AC adaptor and all cords coming from external devices.

**Unplug the AC adaptor from the outlet before cleaning**



- Before cleaning the unit, unplug the AC adaptor from the outlet (p. 11).

 **CAUTION**

**If there is a possibility of lightning strike, disconnect the AC adaptor from the outlet**



- Whenever you suspect the possibility of lightning in your area, disconnect the AC adaptor from the outlet.

**Keep small items out of the reach of children**



- To prevent accidental ingestion of the parts listed below, always keep them out of the reach of small children.
  - Included Parts
    - Rubber Foot (p. 9)

**Handle the ground terminal carefully**



- If you remove the screw from the ground terminal, be sure to replace it; don't leave it lying around where it could accidentally be swallowed by small children. When refastening the screw, make sure that it is firmly fastened, so it won't come loose.

**Take care not to get burned**



- This unit may become hot, so take care to avoid burns.

# IMPORTANT NOTES

## Power Supply

- Do not connect this unit to same electrical outlet that is being used by an electrical appliance that is controlled by an inverter or a motor (such as a refrigerator, washing machine, microwave oven, or air conditioner). Depending on the way in which the electrical appliance is used, power supply noise may cause this unit to malfunction or may produce audible noise. If it is not practical to use a separate electrical outlet, connect a power supply noise filter between this unit and the electrical outlet.
- The AC adaptor will begin to generate heat after long hours of consecutive use. This is normal, and is not a cause for concern.
- To prevent malfunction and equipment failure, always make sure to turn off the power on all your equipment before you make any connections.
- When moved from one location to another where the temperature and/or humidity is very different, water droplets (condensation) may form inside the unit. Damage or malfunction may result if you attempt to use the unit in this condition. Therefore, before using the unit, you must allow it to stand for several hours, until the condensation has completely evaporated.
- Depending on the material and temperature of the surface on which you place the unit, its rubber feet may discolor or mar the surface.  
You can place a piece of felt or cloth under the rubber feet to prevent this from happening. If you do so, please make sure that the unit will not slip or move accidentally.
- Do not place containers or anything else containing liquid on top of this unit. Also, whenever any liquid has been spilled on the surface of this unit, be sure to promptly wipe it away using a soft, dry cloth.

## Placement

- Using the unit near power amplifiers (or other equipment containing large power transformers) may induce hum. To alleviate the problem, change the orientation of this unit; or move it farther away from the source of interference.
- This device may interfere with radio and television reception. Do not use this device in the vicinity of such receivers.
- Noise may be produced if wireless communications devices, such as cell phones, are operated in the vicinity of this unit. Such noise could occur when receiving or initiating a call, or while conversing. Should you experience such problems, you should relocate such wireless devices so they are at a greater distance from this unit, or switch them off.

## Maintenance

- For everyday cleaning wipe the unit with a soft, dry cloth or one that has been slightly dampened with water. To remove stubborn dirt, use a cloth impregnated with a mild, non-abrasive detergent. Afterwards, be sure to wipe the unit thoroughly with a soft, dry cloth.
- Never use benzine, thinners, alcohol or solvents of any kind, to avoid the possibility of discoloration and/or deformation.

### Repairs and Data

- Please be aware that all data contained in the unit's memory may be lost when the unit is sent for repairs. Important data should always be backed up to your computer, or written down on paper (when possible). During repairs, due care is taken to avoid the loss of data. However, in certain cases (such as when circuitry related to memory itself is out of order), we regret that it may not be possible to restore the data, and Roland assumes no liability concerning such loss of data.

### Additional Precautions

- Please be aware that the contents of memory can be irretrievably lost as a result of a malfunction, or the improper operation of the unit. To protect yourself against the risk of losing important data, we recommend that you periodically save a backup copy of important data you have stored in the unit's memory to your computer.
- Unfortunately, it may be impossible to restore the contents of data that was stored in the unit's memory or in your computer once it has been lost. Roland Corporation assumes no liability concerning such loss of data.
- Use a reasonable amount of care when using the unit's jacks and connectors. Rough handling can lead to malfunctions.
- When disconnecting all cables, grasp the connector itself - never pull on the cable. This way you will avoid causing shorts, or damage to the cable's internal elements.
- To avoid disturbing others nearby, try to keep the unit's volume at reasonable levels.
- When you need to transport the unit, package it in the box (including padding) that it came in, if possible. Otherwise, you will need to use equivalent packaging materials.

- Some connection cables contain resistors. Do not use cables that incorporate resistors for connecting to this unit. The use of such cables can cause the sound level to be extremely low, or impossible to hear. For information on cable specifications, contact the manufacturer of the cable.

### About Intellectual Property Rights

- Roland is an either registered trademark or trademark of Roland Corporation in the United States and/or other countries.
- Company names and product names appearing in this document are registered trademarks or trademarks of their respective owners.
- Do not use this product for purposes that could infringe on a copyright held by a third party. We assume no responsibility whatsoever with regard to any infringements of third-party copyrights arising through your use of this product.
- MMP (Moore Microprocessor Portfolio) refers to a patent portfolio concerned with microprocessor architecture, which was developed by Technology Properties Limited (TPL). Roland has licensed this technology from the TPL Group.



# Check the Included Items

The following items are included. Please make sure that all items are present. If anything is missing, please contact your dealer.

## VC-1-DL itself



## Owner's manual

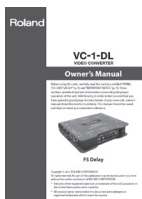

## AC adaptor and power cord



## Rubber feet



- \* The rubber feet are arranged onto one pad. Remove each one from the pad if you wish to install them.
- \* Attach the included rubber feet to the locations of bottom panel below as needed.

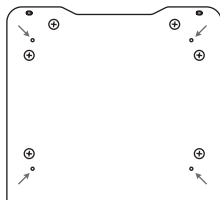

# Contents

---

<b>Check the Included Items .....</b>	<b>9</b>
<b>About the Power Supply .....</b>	<b>11</b>
Connecting the AC Adapter .....	11
About Securing the Power Cord .....	12
Turning the Power On and Off .....	13
About AUTO OFF .....	13
<b>Names of Things and What They Do .....</b>	<b>14</b>
Front Panel .....	14
Rear Panel .....	15
Side Panel .....	15
<b>About Input/Output Formats .....</b>	<b>17</b>
Input Formats .....	17
Output Formats .....	18
<b>Connecting External Equipment.....</b>	<b>19</b>
Connecting Source Equipment.....	19
Connecting Output Equipment.....	21
Connecting a Computer for Remote Control.....	22
<b>Setting the Operation Mode .....</b>	<b>23</b>
<b>Appendices .....</b>	<b>25</b>
Main Specification .....	25
About Remote Control .....	26
Dimensions .....	27
Troubleshooting .....	28

# About the Power Supply

## Connecting the AC Adapter

Connect the AC adapter as shown in the figure below. Place the AC adapter so the side with the indicator (see illustration) faces upwards and the side with textual information faces downwards.

\* The indicator will light when you plug the AC adaptor into an AC outlet.

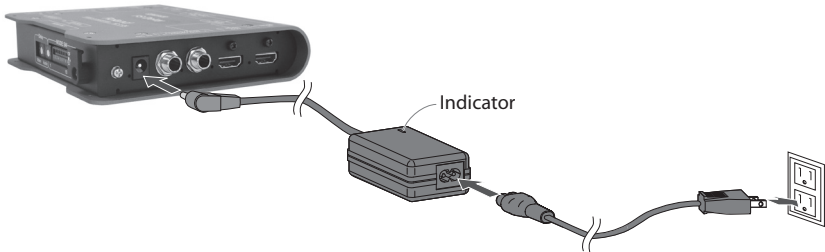

## Caution Regarding the Power Supply

Depending on the circumstances of a particular setup, you may experience a discomforting sensation, or perceive that the surface feels gritty to the touch when you touch this device or the metal portions of connected objects. This is due to an infinitesimal electrical charge, which is absolutely harmless. However, if you are concerned about this, connect the ground terminal (see figure) with an external ground. When the unit is grounded, a slight hum may occur, depending on the particulars of your installation. If you are unsure of the connection method, contact the nearest Roland Service Center, or an authorized Roland distributor, as listed on the "Information" sheet.



### Unsuitable places for connection

- Water pipes (may result in shock or electrocution)
- Gas pipes (may result in fire or explosion)
- Telephone-line ground or lightning rod (may be dangerous in the event of lightning)

## About Securing the Power Cord

You can use either of the two methods described below to secure the power cord in place. Doing this can prevent inadvertent disruption of power to your unit (should the plug be pulled out accidentally) and avoid applying undue stress to the DC IN connector.

### Securing Using the Cord Hook

You can secure the cord in place as shown below.



### Securing Using the Holes in the Top/Bottom Panel

You can secure the cord using the holes in the top or bottom panel, as shown below.



## Turning the Power On and Off

Once everything is properly connected, be sure to follow the procedure below to turn on their power. If you turn on equipment in the wrong order, you risk causing malfunction or equipment failure.

- \* This unit is equipped with a protection circuit. A brief interval (a few seconds) after turning the unit on is required before it will operate normally.
- \* Before turning the unit on/off, always be sure to turn the volume down. Even with the volume turned down, you might hear some sound from the audio output when switching the unit on/off. However, this is normal and does not indicate a malfunction.

### Turning the Power On

#### 1. Connect the peripheral devices.

Connect any video cameras and other equipment. To prevent malfunction or damage, always turn down the volume and turn off the power on all devices before making any connections.

#### 2. Turn on the power to the VC-1-DL.

Inserting the power cord starts the VC-1-DL.

#### 3. Turn on the power to external equipment.

Turn on the power to the external devices connected to the VC-1-DL.

### Turning the Power Off

#### 1. Turn off the power to external equipment.

Turn off the power to the external devices connected to the VC-1-DL.

#### 2. Turn off the power to the VC-1-DL.

Disconnecting the power cord turns off the power.

## About AUTO OFF

The power to this unit will be turned off automatically after a predetermined amount of time (240 minutes) has passed since the last input of signal or others (AUTO OFF function). Conditions of AUTO OFF are as below.

- Mode switch (MODE SW) 10 (CONTROL) is set to [ON]
  - No USB connection to a computer
  - No video input
  - No audio input
- \* To turn on the power again, disconnect and reinsert the power cord. To disable the AUTO OFF feature, set mode switch 10 (CONTROL) to [OFF] (p. 24).  
You can also use dedicated remote-control software to change this setting (p. 26).

# Names of Things and What They Do

## Front Panel

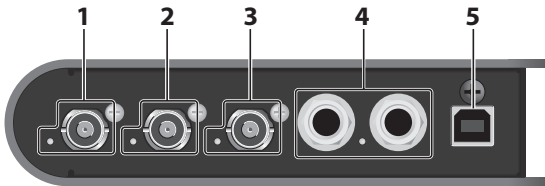

### cf.

For information on what the colors and the lighted and flashing states of the indicators mean, refer to "Indicator Colors/Operation" (p. 16).

#### 1. SDI IN Connector and Indicator

Connect a video camera or other SDI source equipment.

#### 2. SDI OUT Connector and Indicator

Connect a video deck, monitor, or other SDI output device.

#### 3. REF IN Connector and Indicator

Connect a clock source device for synchronization.

\* It is possible to use this unit as a frame synchronizer when supported sync signal is input (p. 20).

#### 4. AUDIO IN Connectors and Indicator

Connect a mixer or other audio sources. You can use the mode switches (MODE SW) to switch between analog input and AES input (p. 23).

\* The VC-1-DL can output video and audio together (embedded audio feature).

#### 5. USB Port

Connect a computer used for remote control.

\* Operating the VC-1-DL by remote control requires downloading dedicated software (VC-1 RCS) and installing it on a computer. You can download the dedicated software from the following Roland website.

<http://www.rolandsystemsgroup.net/>

## Rear Panel

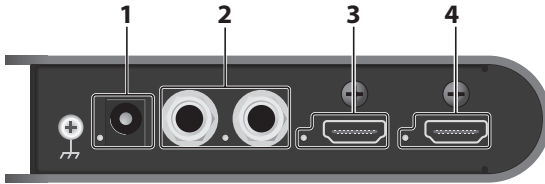

### 1. DC IN Connector and Indicator

Connect the included AC adapter. The indicator lights up when the VC-1-DL is receiving power.

### 2. AUDIO OUT Connectors and Indicator

Connect bi-amp speakers or other audio output equipment.

### 3. HDMI OUT Connector and Indicator

Connect a TV monitor or other HDMI output equipment.

### 4. HDMI IN Connector and Indicator

Connect a video camera or other HDMI source equipment.

## Side Panel

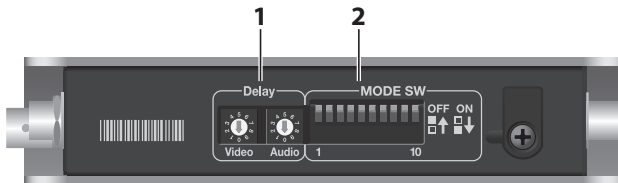

### 1. Delay Dials

These set the amount of delay for video and audio. You can set the amount of delay independently for video and audio, in a range of 0 to 9 fields (0 to 4.5 frames) for each. Use a flathead screwdriver to turn the dials.

### 2. Mode Switches (MODE SW)

These set the VC-1-DL's operation mode. Refer to "Setting the Operation Mode" (p. 23). Use a fine-pointed pen or similar object to change the setting of a switch.

## Indicator Colors/Operation

### SDI IN/OUT

Red	SD-SDI input/output
Orange	HD-SDI input/output
Green	3G-SDI input/output

SDI IN	Lighted	Proper input
	Flashing	Unsupported signal is input
SDI OUT	Lighted	Proper output
	Flashing	Cannot output properly

### HDMI IN/OUT

Red	RGB input/output
Orange	YCC 444 input/output
Green	YCC 422 input/output
Flashing	Cannot input/output properly because of no HDCP support, etc.

### AUDIO IN/OUT

Analog in/out	Green/lighted	-24 dB input/output
	Red/lighted	-6 dB input/output
AES in/out	Orange/lighted	Proper input/output
	Orange/flashing	Cannot input/output properly

### REF IN

Lighted	The unit locks to clock from the source device
Flashing	Unsupported clock is input
Unlighted	No input via REF IN (in this case, the unit locks to SDI or HDMI)



# About Input/Output Formats

## Input Formats

### SDI IN Connector

Video	1920 x 1080	60p, 59.94p, 50p, 30p, 29.97p, 25p, 24p, 23.98p, 60i, 59.94i, 50i
	1280 x 720	60p, 59.94p, 50p, 30p, 29.97p, 25p
	720 x 487	59.94i
	720 x 576	50i
Audio	Linear PCM, 24 bits/48 kHz, 16 channels	

### HDMI IN Connector

Video	1920 x 1080	60p, 59.94p, 50p, 30p, 29.97p, 25p, 24p, 23.98p, 60i, 59.94i, 50i
	1280 x 720	60p, 59.94p, 50p, 30p, 29.97p, 25p
	720 x 480	59.94i
	720 x 576	50i
Audio	Linear PCM, 24 bits/48 kHz, 8 channels	

- \* The VC-1-DL supports HDCP (High-bandwidth Digital Content Protection system). When an HDCP-applied signal is input, output is possible from only the HDMI OUT connector. Output from the SDI OUT connector and AUDIO OUT connectors is stopped.

### AUDIO IN Connectors

Analog audio	Nominal input level	+4 dBu
	Maximum input level	+24 dBu
	Input impedance	150 k ohms
Digital audio	Format	AES3, 24 bits/48 kHz, 2 channels
	Input impedance	110 ohms

## Output Formats

### NOTE

The VC-1-DL does not support up/down conversion, cross conversion, interlaced to progressive (I/P) scan conversion, or frame rate conversion. See the Roland VC-300HD if you need this functionality.

### SDI OUT Connector

Video	1920 x 1080	60p, 59.94p, 50p, 30p, 29.97p, 25p, 24p, 23.98p, 60i, 59.94i, 50i
	1280 x 720	60p, 59.94p, 50p, 30p, 29.97p, 25p
	720 x 487	59.94i
	720 x 576	50i
Audio	Linear PCM, 24 bits/48 kHz, 16 channels * 2 channels when REF IN is used.	

### HDMI OUT Connector

Video	1920 x 1080	60p, 59.94p, 50p, 30p, 29.97p, 25p, 24p, 23.98p, 60i, 59.94i, 50i
	1280 x 720	60p, 59.94p, 50p, 30p, 29.97p, 25p
	720 x 480	59.94i
	720 x 576	50i
Audio	Linear PCM, 24 bits/48 kHz, 8 channels * 2 channels when REF IN is used.	

### AUDIO OUT Connectors

Analog audio	Nominal output level	+4 dBu
	Maximum output level	+24 dBu
	Output impedance	600 ohms
Digital audio	Format	AES3, 24 bits/48 kHz, 2 channels
	Output impedance	110 ohms

# Connecting External Equipment

## MEMO

For information on operation modes refer to “Setting the Operation Mode” (p. 23).

## Connecting Source Equipment

### Connecting SDI Equipment

Connect a video camera or other device capable of SDI output to the SDI IN connector.

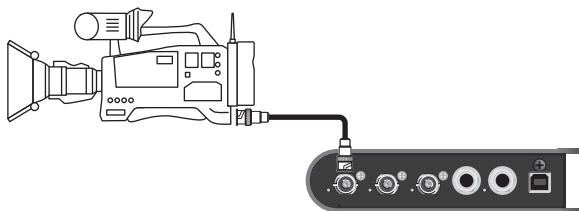

### Connecting HDMI Equipment

Connect a video camera or other device capable of HDMI output to the HDMI IN connector.

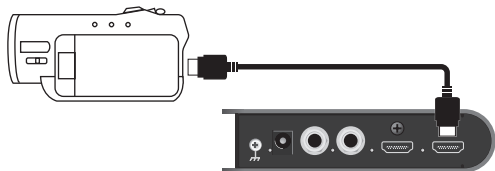

## Connecting Audio Source Equipment

### Connecting an Analog Audio Source

Connect an audio mixer or other analog output to the AUDIO IN connectors.

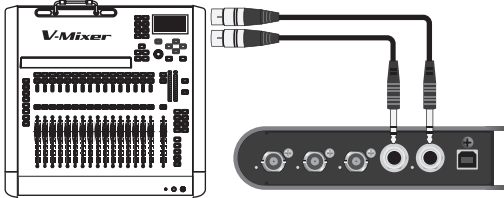

\* This unit is equipped with balanced (TRS) type jacks. Wiring diagrams for these jacks are shown below. Make connections after first checking the wiring diagrams of other equipment you intend to connect.



### Connecting a Digital Audio Source

Change the setting (p. 23) to input AES signals. When you are doing this, use only the R-channel of AUDIO IN connectors. The L-channel is invalid when the setting is changed to input AES signals.

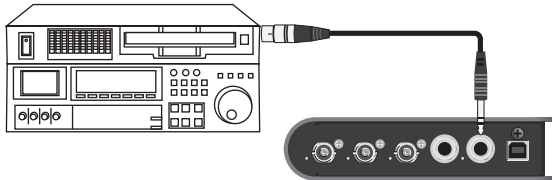

## Connecting a Clock Source

Connect a clock source to the REF IN connector. The VC-1-DL supports the following external clocks.

- Black burst
- Bi-level/Tri-level synchronization

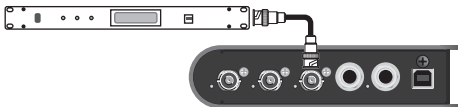

### NOTE

Never input a signal that includes video. Doing so might cause synchronization to be lost.

## Connecting Output Equipment

### Connecting SDI Equipment

Connect a video deck or other equipment capable of SDI input to the SDI OUT connector.

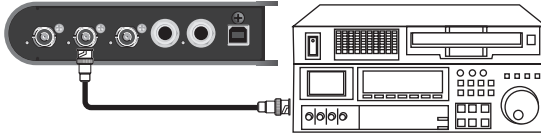

### Connecting HDMI Equipment

Connect a TV monitor or other equipment capable of HDMI input to the HDMI OUT connector.

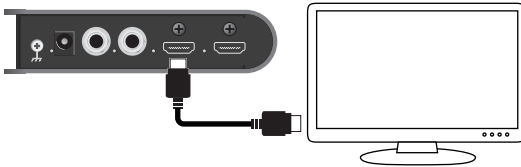

### Connecting Audio Output Equipment

#### Connecting Analog Output Equipment

Connect bi-amp speakers or the like to the AUDIO OUT connectors.

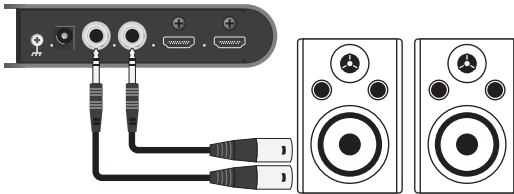

### Connecting Digital Output Equipment

Change the setting (p. 23) to output AES signals. When you are doing this, use only the R-channel of AUDIO OUT connectors. The L-channel is invalid when the setting is changed to output AES signals.

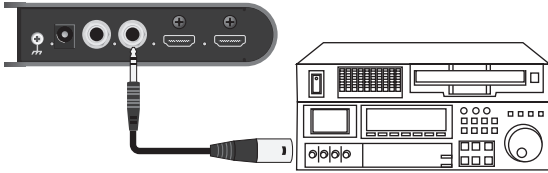

## Connecting a Computer for Remote Control

Connect a computer for remote control to the USB port.

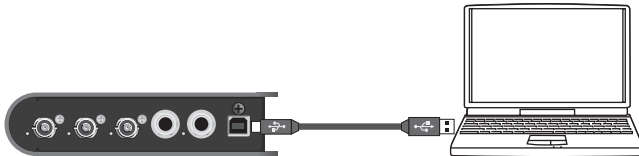

\* Operating the VC-1-DL by remote control requires downloading dedicated software (VC-1 RCS) and installing it on a computer. You can download the dedicated software from the following Roland website.

<http://www.rolandsystemsgroup.net/>

### MEMO

The VC-1 RCS enables you to make detailed settings that cannot be made using the unit's mode switches. The values of the settings are saved to the unit's internal memory. You can use such saved settings even when you are using the unit alone, without connecting a computer.

# Setting the Operation Mode

Use the mode switches (MODE SW) on the side panel to set the operation mode of the VC-1-DL. By default, only switch 10 is set to [ON]. Before making any setting changes, first set switch 10 to [OFF].

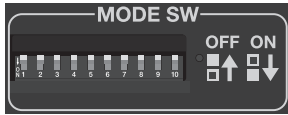

Operating switches 1 through 10 makes the VC-1-DL operate as described below.

## MODE SW 1

This specifies the type of audio input/output.

OFF	Analog audio is input/output.
ON	AES3 is input/output.

## MODE SW 2

This specifies whether incoming signals from AUDIO IN are embedded in output (SDI/HDMI).

OFF	Not embedded
ON	Embedded

## MODE SW 3/4

This specifies the channels of SDI/HDMI output on which the audio inputs are embedded. Combinations of 3 and 4 specify the channels for embedding as described below.

3	OFF	4	OFF	Embedded on channels 1 and 2
3	ON	4	OFF	Embedded on channels 3 and 4
3	OFF	4	ON	Embedded on channels 5 and 6
3	ON	4	ON	Embedded on channels 7 and 8

## MODE SW 5

This specifies the groups for embedding/de-embedding the SDI audio.

OFF	8 channels of Group 1 and Group 2
ON	8 channels of Group 3 and Group 4

**MODE SW 6/7**

This specifies the audio channels assigned to signals from the AUDIO OUT connectors. Combinations of 6 and 7 specify the assigned channels as described below.

6	OFF	7	OFF	Channels 1 and 2 assigned
6	ON	7	OFF	Channels 3 and 4 assigned
6	OFF	7	ON	Channels 5 and 6 assigned
6	ON	7	ON	Channels 7 and 8 assigned

**MODE SW 8**

This specifies the enabled video source.

OFF	SDI input is enabled
ON	HDMI input is enabled

**MODE SW 9**

This specifies the type of 3G-SDI output coming out from the SDI OUT connector.

\* The signal type of SDI IN is detected automatically.

OFF	Output with Level A mapping structure
ON	Output with Level B mapping structure

**MODE SW 10**

This specifies the control mode.

\* This also enables/disables the AUTO OFF function (p. 13).

OFF	Mode is controlled by switches 1-9..
ON	The unit operates according to the settings in the internal memory (Set with VC-1 RCS software)

You can carry out detailed settings and save to unit's internal memory using the dedicated remote control software, the VC-1 RCS (p. 26).

**About the Delay Dials**

These set the amount of delay for video and audio. You can set the amount of delay independently for video and audio, in a range of 0 to 9 fields (0 to 4.5 frames) for each.

\* When there is input to the REF IN connector, the delay caused by the frame-synchronizer operation is added to the amount you have set.





# Appendices

## Main Specification

### Input/Output Formats

Refer to “About Input/Output Formats” (p. 17).

### Input Connectors

SDI	BNC type x 1
HDMI	Type A (19 pins) x 1
Analog Audio	TRS phone type (balanced) x 1 pair (L/R)
Digital Audio	TRS phone type x 1 (combination use with analog audio R-channel)

### Output Connectors

SDI	BNC type x 1
HDMI	Type A (19 pins) x 1
Analog Audio	TRS phone type (balanced) x 1 pair (L/R)
Digital Audio	TRS phone type x 1 (combination use with analog audio R-channel)

### Other Connectors

Reference	BNC type x 1
USB	Type B (Hi-Speed USB) x 1

### Signal Standards

SDI	SMPTE 424M (SMPTE 425M-AB), SMPTE 292M, SMPTE 259M-C
Reference	Black Burst, bi-level/tri-level

### Signal Level/Impedance

Analog Audio	Nominal Input Level	+4 dBu
	Maximum Input Level	+24 dBu
	Input Impedance	150 k ohms
	Output Impedance	600 ohms
Digital Audio	Input/Output Impedance	110 ohms
Reference	Input Impedance	75 ohms

**Others**

Power Supply	DC 9V (AC Adaptor)
Power Consumption	8W
Dimensions	150 (W) x 130 (D) x 30 (H) mm 5-15/16 (W) x 5-1/8 (D) x 1-3/16 (H) inches
Weight	500 g 1 lb 2 oz (excluding AC adaptor)
Operation Temperature	+0 -- +40 degrees Celsius +41 -- +104 degrees Fahrenheit
Accessories	AC adaptor, Power Cord, Rubber Foot (four), Owner's Manual

\* In the interest of product improvement, the specifications and/or appearance of this unit are subject to change without prior notice.

## About Remote Control

You can operate the VC-1-DL by remote control from a computer on which dedicated software (VC-1 RCS) is installed and set up. You can download the dedicated software from the following Roland website.

<http://www.rolandsystemsgroup.net/>

## Dimensions

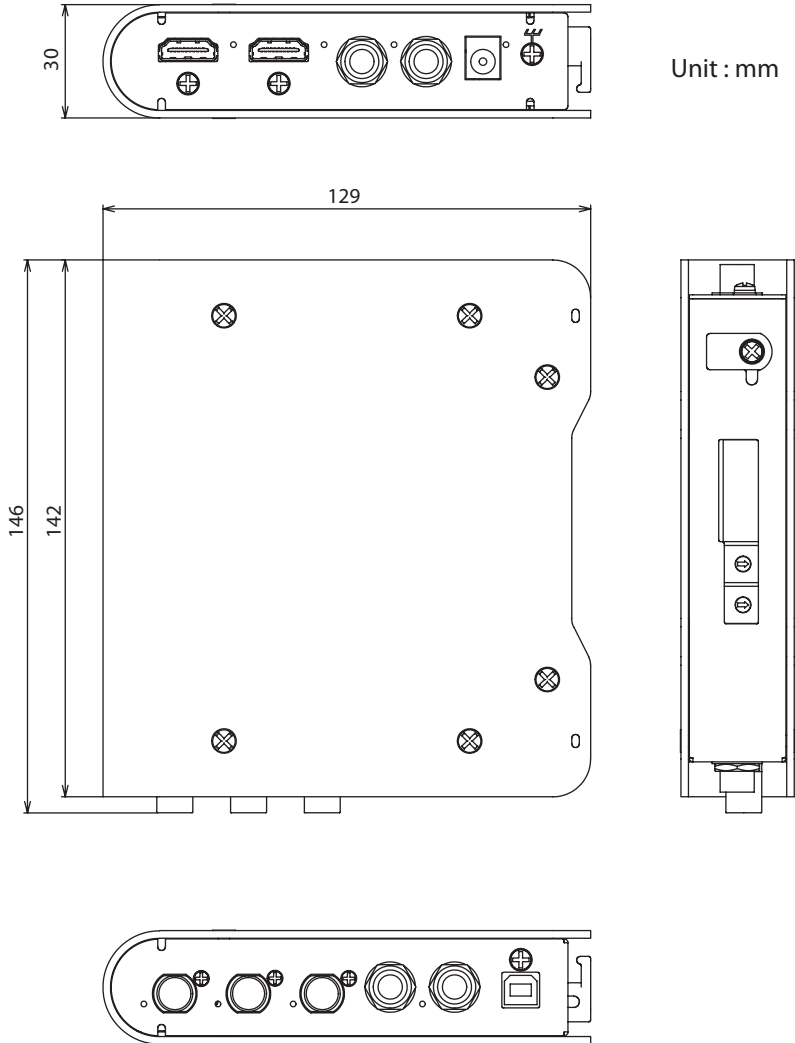

## Troubleshooting

### **Nothing is output from the SDI OUT connector.**

Is an HDCP-applied signal being input via the HDMI IN connector? The VC-1-DL supports HDCP, and when an HDCP-applied signal is input, output via the SDI OUT connector stops. When this happens, output is made only via the HDMI OUT connector.

### **No audio is output from the HDMI IN connector.**

Does the connected HDMI source device support linear PCM output? The VC-1-DL supports linear PCM at only 48 kHz. Accordingly, if a different format is input, audio might not be output, or the number of channels might be limited.

### **After a period of no operation, the unit turned itself off.**

Is the AUTO OFF feature activated? By default, the AUTO OFF feature is set to ON. When the unit is to be left powered up for a long time, set mode switch 10 to [OFF] to turn off the AUTO OFF feature.

### **Input/output of AES audio is not possible.**

Is the connection to the source device or the output device made via the L channel? When the mode switches have been set to enable AES input/output, only the R-channel jacks are active, and the L-channel ports are disabled.

### **Settings cannot be changed using the mode switches.**

Is mode switch 10 at the [ON] position? When making setting changes, be sure to set switch 10 to [OFF].

### **The volume level of equipment connected to the AUDIO IN jacks is low.**

Are you using connection cables that contain resistors? Use connector cables that do not contain resistors.



This product complies with the requirements of EMC Directive 2004/108/EC.

For EU Countries

## FEDERAL COMMUNICATIONS COMMISSION RADIO FREQUENCY INTERFERENCE STATEMENT

This equipment has been tested and found to comply with the limits for a Class B digital device, pursuant to Part 15 of the FCC Rules. These limits are designed to provide reasonable protection against harmful interference in a residential installation. This equipment generates, uses, and can radiate radio frequency energy and, if not installed and used in accordance with the instructions, may cause harmful interference to radio communications. However, there is no guarantee that interference will not occur in a particular installation. If this equipment does cause harmful interference to radio or television reception, which can be determined by turning the equipment off and on, the user is encouraged to try to correct the interference by one or more of the following measures:

- Reorient or relocate the receiving antenna.
- Increase the separation between the equipment and receiver.
- Connect the equipment into an outlet on a circuit different from that to which the receiver is connected.
- Consult the dealer or an experienced radio/TV technician for help.

This device complies with Part 15 of the FCC Rules. Operation is subject to the following two conditions:

- (1) this device may not cause harmful interference, and
- (2) this device must accept any interference received, including interference that may cause undesired operation.

This equipment requires shielded interface cables in order to meet FCC class B limit. Any unauthorized changes or modifications not expressly approved by the party responsible for compliance could void the user's authority to operate the equipment.

For the USA

For Canada

### NOTICE

This Class B digital apparatus meets all requirements of the Canadian Interference-Causing Equipment Regulations.

### AVIS

Cet appareil numérique de la classe B respecte toutes les exigences du Règlement sur le matériel brouilleur du Canada.

For C.A. US (Proposition 65)

### WARNING

This product contains chemicals known to cause cancer, birth defects and other reproductive harm, including lead.

For the USA

## DECLARATION OF CONFORMITY Compliance Information Statement

**Model Name :** VC-1-DL  
**Type of Equipment :** Video Converter  
**Responsible Party :** Roland Systems Group U.S.  
**Address :** 5100 S.Eastern Avenue, Los Angeles, CA 90040-2938, U.S.A.  
**Telephone :** (323) 890 3700

**For EU Countries**



- UK** This symbol indicates that in EU countries, this product must be collected separately from household waste, as defined in each region. Products bearing this symbol must not be discarded together with household waste.
- DE** Dieses Symbol bedeutet, dass dieses Produkt in EU-Ländern getrennt vom Hausmüll gesammelt werden muss gemäß den regionalen Bestimmungen. Mit diesem Symbol gekennzeichnete Produkte dürfen nicht zusammen mit den Hausmüll entsorgt werden.
- FR** Ce symbole indique que dans les pays de l'Union européenne, ce produit doit être collecté séparément des ordures ménagères selon les directives en vigueur dans chacun de ces pays. Les produits portant ce symbole ne doivent pas être mis au rebut avec les ordures ménagères.
- IT** Questo simbolo indica che nei paesi della Comunità europea questo prodotto deve essere smaltito separatamente dai normali rifiuti domestici, secondo la legislazione in vigore in ciascuna paese. I prodotti che riportano questo simbolo non devono essere smaltiti insieme ai rifiuti domestici. Ai sensi dell'art. 13 del D.Lgs. 25 luglio 2005 n. 151.
- ES** Este símbolo indica que en los países de la Unión Europea este producto debe recogerse aparte de los residuos domésticos, tal como está regulado en cada zona. Los productos con este símbolo no se deben depositar con los residuos domésticos.
- PT** Este símbolo indica que nos países da UE, a recolha deste produto deve ser feita separadamente do lixo doméstico, de acordo com os regulamentos de cada região. Os produtos que apresentem este símbolo não deverão ser eliminados juntamente com o lixo doméstico.
- NL** Dit symbool geeft aan dat in landen van de EU dit product gescheiden van huishoudelijk afval moet worden aangeboden, zoals bepaald per gemeente of regio. Producten die van dit symbool zijn voorzien, mogen niet samen met huishoudelijk afval worden verwijderd.
- DK** Dette symbol angiver, at i EU-lande skal dette produkt opsamles adskilt fra husholdningsaffald, som defineret i hver enkelt region. Produkter med dette symbol må ikke smides ud sammen med husholdningsaffald.
- NO** Dette symbolet indikerer at produktet må behandles som spesialavfall i EU-land, iht. til retningslinjer for den enkelte regionen, og ikke kastes sammen med vanlig husholdningsavfall. Produkter som er merket med dette symbolet, må ikke kastes sammen med vanlig husholdningsavfall.

- SE** Symbolen anger att i EU-länder måste den här produkten kasseras separat från hushållsavfall, i enlighet med varje regions bestämmelser. Produkter med den här symbolen får inte kasseras tillsammans med hushållsavfall.
- FI** Tämä merkintä ilmaisee, että tuote on EU-maissa kerättävä erillään kotitalousjättestä kunkin alueen voimassa olevien määräysten mukaisesti. Tällä merkinnällä varustettuja tuotteita ei saa hävittää kotitalousjätteen mukana.
- HU** Ez a szimbólum azt jelenti, hogy az Európai Unióban ezt a terméket a háztartási hulladéktól elkülönítve, az adott régióban érvényes szabályozás szerint kell gyűjteni. Az ezzel a szimbóllumal ellátott termékeket nem szabad a háztartási hulladék közé dobni.
- PL** Symbol oznacza, że zgodnie z regulacjami w odpowiednim regionie, w krajach UE produktu nie należy wyrzucać z odpadami domowymi. Produktów opatrzonych tym symbolem nie można utylizować razem z odpadami domowymi.
- CZ** Tento symbol udává, že v zemích EU musí být tento výrobek sbíráán odděleně od domácího odpadu, jak je určeno pro každý region. Výrobky nesoucí tento symbol se nesmí vyhozovat spolu s domácími odpadem.
- SK** Tento symbol vyjadruje, že v krajinách EU sa musí zbierať tohto produktu vykonávať oddelene od domáceho odpadu, podľa nariadení platných v konkrétnej krajine. Produkty s týmto symbolom sa nesmú vyhazovať spolu s domovým odpadom.
- EE** See sümbol näitab, et EL-i maades tuleb see toode olemprüfungist eraldi koguda, nii nagu on igas piirkonnas määratletud. Selle sümboliga märgitud tooteid ei tohi ära visata koos olemprüfungiga.
- LT** Šis simbolis rodo, kad ES valsts šis produkts turi būti surenkamas atskirai nuo buitinių atliekų, kaip nustatyta kiekviename regione. Šiuo simboliu paženklinoti produktai neturi būti išmetami kartu su buitiniems atliekomis.
- LV** Šis simbols norāda, ka ES valstīs šo produktu jāievāc atsevišķi no mājāsniecības atkritumiem, kā noteikts katrā reģionā. Produkts ar šo simbolu nedrīkst izmest kopā ar mājāsniecības atkritumiem.
- SI** Ta simbol označuje, da je treba proizvod v državah EU zbirati ločeno od gospodinskih odpadkov, tako kot je določeno v vsaki regiji. Proizvoda s tem znakom ni dovoljeno odlagati skupaj z gospodinskimi odpadki.
- GR** Το σύμβολο αυτό υποδηλώνει ότι στις χώρες της Ε.Ε. το συγκεκριμένο προϊόν πρέπει να συλλέγεται χωριστά από τα απορρίμματα οικιακής απορριμμάτων, σύμφωνα με όσα προβλέπονται σε κάθε περιοχή. Τα προϊόντα που φέρουν το συγκεκριμένο σύμβολο δεν πρέπει να απορριπώνονται μαζί με τα οικιακά απορρίμματα.

**For China**

**有关产品中所含有害物质的说明**

本资料就本公司产品中所含的特定有害物质及其安全性予以说明。  
本资料适用于 2007 年 3 月 1 日以后本公司所制造的产品。

**环保使用期限**



此标志适用于在中国国内销售的电子信息产品，表示环保使用期限的年限。所谓环保使用期限是指在自制造日起的规定期限内，产品中所含的有害物质不致引起环境污染，不会对人身、财产造成严重的不良影响。环保使用期限仅在遵照产品使用说明书，正确使用产品的条件下才有效。不当的使用，将会导致有害物质泄漏的危险。

**产品中有毒有害物质或元素的名称及含量**

部件名称	有毒有害物质或元素					
	铅(Pb)	汞(Hg)	镉(Cd)	六价铬(Cr(VI))	多溴联苯(PBB)	多溴二苯醚(PBDE)
外壳(壳体)	×	○	○	○	○	○
电子部件(印刷电路板等)	×	○	×	○	○	○
附件(电源线、交流适配器等)	×	○	○	○	○	○

○：表示该有毒有害物质在该部件所有均质材料中的含量均在 SJ/T11363-2006 标准规定的限量要求以下。

×：表示该有毒有害物质至少在该部件的某一均质材料中的含量超出 SJ/T11363-2006 标准规定的限量要求。

因根据现有的技术水平，还没有什么物质能够代替它。



