

visual engineering  
**LIGHTWARE**

**User's Manual**



**HDMI20-OPTC-TX220-Pro**  
**HDMI20-OPTC-RX220-Pro**

Multimode Single Fiber Optical Extender

## Important Safety Instructions

### Class I apparatus construction

This equipment must be used with a mains power system with a protective earth connection. The third (earth) pin is a safety feature, do not bypass or disable it. The equipment should be operated only from the power source indicated on the product.

To disconnect the equipment safely from power, remove the power cord from the rear of the equipment, or from the power source. The MAINS plug is used as the disconnect device, the disconnect device shall remain readily operable.

There are no user-serviceable parts inside of the unit. Removal of the cover will expose dangerous voltages. To avoid personal injury, do not remove the cover. Do not operate the unit without the cover installed.

The appliance must be safely connected to multimedia systems. Follow instructions described in this manual.

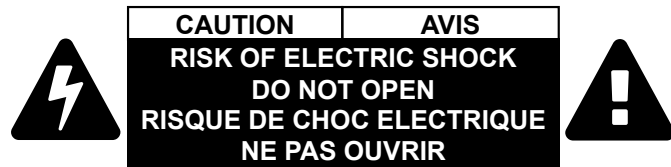

### Ventilation

For the correct ventilation and to avoid overheating ensure enough free space around the appliance. Do not cover the appliance, let the ventilation holes free and never block or bypass the ventilators (if any).

### WARNING

To prevent injury, the apparatus is recommended to securely attach to the floor/wall or mount in accordance with the installation instructions. The apparatus shall not be exposed to dripping or splashing and that no objects filled with liquids, such as vases, shall be placed on the apparatus. No naked flame sources, such as lighted candles, should be placed on the apparatus.

## Waste Electrical & Electronic Equipment WEEE

This marking shown on the product or its literature, indicates that it should not be disposed with other household wastes at the end of its working life. To prevent possible harm to the environment or human health from uncontrolled waste disposal, please separate this from other types of wastes and recycle it responsibly to promote the sustainable reuse of material resources. Household users should contact either the retailer where they purchased this product, or their local government office, for details of where and how they can take this item for environmentally safe recycling. Business users should contact their supplier and check the terms and conditions of the purchase contract. This product should not be mixed with other commercial wastes for disposal.



### Caution: Laser product

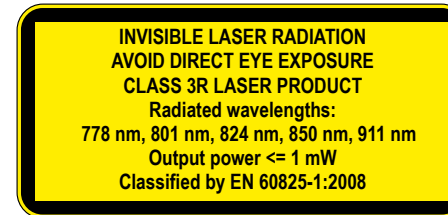
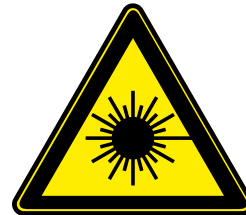

## Common Safety Symbols

Symbol	Description
	Alternating current
	Protective conductor terminal
	Caution, possibility of electric shock
	Caution
	Laser radiation

## Symbol Legend

The following symbols and markings are used in the document:

**WARNING!** Safety-related information which is highly recommended to read and keep in every case!

**ATTENTION!** Useful information to perform a successful procedure; it is recommended to read.

**INFO:** A notice which contains additional information. Procedure can be successful without reading it.

**DEFINITION:** The short description of a feature or a function.

**TIPS AND TRICKS:** Ideas which you may have not known yet but can be useful.

## Navigation Buttons

 Go back to the previous page. If you clicked on a link previously, you can go back to the source page by clicking the button.

 Navigate to the Table of Contents.

 Step back one page.

 Step forward to the next page.

## Document Information

All presented functions refer to the indicated products. The descriptions have been made during testing these functions in accordance with the indicated Hardware/Firmware/Software environment:

Item	Version
Lightware Device Controller (LDC) software	1.21.0
Lightware Device Updater Software	1.5.2
Controller firmware	1.1.0
Hardware	1.2

Document revision: **1.1**

Release date: 28-02-2018

Editor: Judit Barsony

## Table of Contents

<b>1. INTRODUCTION</b> .....	<b>6</b>	<b>4.3. FRONT PANEL LCD MENU OPERATIONS</b> .....	<b>21</b>	<b>6. LW3 PROGRAMMERS' REFERENCE</b> .....	<b>38</b>
<b>1.1. DESCRIPTION</b> .....	6	4.3.1. System Settings Menu .....	21	<b>6.1. OVERVIEW</b> .....	<b>38</b>
<b>1.2. MODEL DENOMINATION</b> .....	6	4.3.2. Ports Menu .....	22	6.1.1. Elements of the Tree Structure .....	38
<b>1.3. BOX CONTENTS</b> .....	6	4.3.3. EDID Menu .....	22	6.1.2. Escaping.....	40
<b>1.4. COMPATIBLE DEVICES</b> .....	6	4.3.4. Health Menu.....	23	6.1.3. Error Messages.....	40
<b>1.5. FEATURES OF THE DEVICE</b> .....	6	4.3.5. Remote Menu .....	23	6.1.4. Prefix Summary .....	40
<b>1.6. TYPICAL APPLICATION</b> .....	7	<b>5. SOFTWARE CONTROL – LIGHTWARE DEVICE CONTROLLER</b> ...	<b>24</b>	<b>6.2. THE TREE STRUCTURE</b> .....	<b>40</b>
1.6.1. Integrated System Application .....	7	<b>5.1. INSTALL AND UPGRADE</b> .....	<b>24</b>	<b>6.3. LW3 COMMANDS</b> .....	<b>41</b>
1.6.2. Standalone Application .....	8	<b>5.2. ESTABLISHING THE CONNECTION</b> .....	<b>24</b>	6.3.1. Get Command.....	41
<b>2. INSTALLATION</b> .....	<b>9</b>	<b>5.3. CROSSPOINT MENU - HDMI20-OPTC-TX220-Pro</b> .....	<b>25</b>	6.3.2. Set Command .....	42
<b>2.1. MOUNTING OPTIONS</b> .....	<b>9</b>	<b>5.4. PORT PROPERTIES WINDOW</b> .....	<b>26</b>	6.3.3. Invocation .....	42
2.1.1. Truss Mounting - HDMI20-OPTC-RX220-Pro .....	9	5.4.1. HDMI Input Port -Transmitter .....	26	6.3.4. Manual .....	43
2.1.2. Standard Rack Installation .....	9	5.4.2. HDMI Output Port - Transmitter.....	26	6.3.5. Signature.....	43
2.1.3. Rack Shelf Mounting (with 1U high Rack Shelf).....	10	5.4.3. Optical Input Port - Receiver.....	27	6.3.6. Subscription.....	43
<b>2.2. CONNECTING STEPS</b> .....	<b>11</b>	5.4.4. HDMI Output Port - Receiver.....	27	6.3.7. Notifications about the Changes of the Properties .....	44
<b>3. PRODUCT OVERVIEW</b> .....	<b>12</b>	<b>5.5. EDID MENU</b> .....	<b>28</b>	<b>6.4. FORMAL DEFINITIONS</b> .....	<b>44</b>
<b>3.1. FRONT VIEW</b> .....	<b>12</b>	5.5.1. Sources and Destinations.....	28	<b>6.5. SYSTEM COMMANDS</b> .....	<b>45</b>
<b>3.2. REAR VIEW</b> .....	<b>13</b>	5.5.2. EDID Operations.....	28	6.5.1. Querying the Product Name .....	45
<b>3.3. ELECTRICAL CONNECTIONS</b> .....	<b>13</b>	5.5.3. EDID Summary Window .....	29	6.5.2. Setting the Device Label.....	45
<b>3.4. MULTIMODE SINGLE FIBER EXTENDER CONCEPT</b> .....	<b>14</b>	5.5.4. Editing an EDID .....	29	6.5.3. Querying the Serial Number .....	45
3.4.1. Summary of Interfaces - Transmitter .....	14	5.5.5. Creating an EDID.....	30	6.5.4. Querying the Firmware Version .....	45
3.4.2. Summary of Interfaces - Receiver .....	14	<b>5.6. CONTROL MENU</b> .....	<b>30</b>	6.5.5. Resetting the Extender .....	45
<b>3.5. OPTICAL INTERFACE</b> .....	<b>15</b>	5.6.1. RS-232 Tab.....	30	6.5.6. Restoring the Factory Default Settings .....	45
<b>3.6. VIDEO AND AUDIO INTERFACE</b> .....	<b>16</b>	5.6.2. Ethernet Tab .....	31	6.5.7. Locking Front Panel.....	45
3.6.1. Output Conversion Modes .....	16	<b>5.7. EVENT MANAGER</b> .....	<b>31</b>	6.5.8. Enabling Dark Mode .....	45
3.6.2. Autoselect Feature .....	16	5.7.1. The Event Editor.....	32	6.5.9. Setting the Dark Mode Delay .....	46
<b>3.7. CONTROL FEATURES</b> .....	<b>17</b>	5.7.2. Create or Modify an Event.....	32	6.5.10. Setting the Dark Mode on the Remote Device.....	46
3.7.1. USB Control Interface.....	17	5.7.3. Special Tools and Accessories.....	34	6.5.11. Setting the Rotary Direction of the Jog Dial Knob.....	46
3.7.2. Ethernet Interface.....	17	5.7.4. Clear One or More Event(s).....	34	<b>6.6. VIDEO PORT AND CROSSPOINT SETTINGS</b> .....	<b>46</b>
3.7.3. Serial Interface.....	18	5.7.5. Export and Import Events .....	34	6.6.1. Querying the Crosspoint Setting.....	46
<b>4. OPERATION</b> .....	<b>19</b>	<b>5.8. SETTINGS MENU</b> .....	<b>35</b>	6.6.2. Switching Video Input .....	46
<b>4.1. POWERING ON</b> .....	<b>19</b>	5.8.1. Status Tab .....	35	6.6.3. Querying the Status of Source Ports.....	47
<b>4.2. FRONT PANEL OPERATIONS</b> .....	<b>19</b>	5.8.2. Network Tab.....	35	6.6.4. Querying the Status of Destination Ports .....	48
4.2.1. Function Button - HDMI20-OPTC-TX220-Pro.....	20	5.8.3. Front Panel Tab.....	35	6.6.5. Muting Input Port.....	48
4.2.2. Boot Button .....	20	5.8.4. Backup Tab (Configuration Cloning) .....	36	6.6.6. Unmuting Input Port .....	48
4.2.3. Function Button - HDMI20-OPTC-RX220-Pro.....	20	5.8.5. System .....	37	6.6.7. Locking Input Port.....	48
4.2.4. Boot Button .....	20	<b>5.9. ADVANCED VIEW WINDOW</b> .....	<b>37</b>	6.6.8. Unlocking Input Port.....	48

<b>6.7. NETWORK CONFIGURATION .....</b>	<b>50</b>	<b>7. FIRMWARE UPGRADE .....</b>	<b>57</b>
6.7.1. Querying the IP Address.....	50	<b>7.1. ABOUT THE FIRMWARE PACKAGE (LFP FILE).....</b>	<b>57</b>
6.7.2. Changing the IP Address (Static) .....	50	<b>7.2. SHORT INSTRUCTIONS.....</b>	<b>57</b>
6.7.3. Querying the Subnet Mask.....	50	<b>7.3. INSTALL AND UPGRADE .....</b>	<b>57</b>
6.7.4. Changing the Subnet Mask (Static) .....	50	<b>7.4. DETAILED INSTRUCTIONS.....</b>	<b>58</b>
6.7.5. Querying the Gateway Address .....	50	7.4.1. Establish the Connection .....	58
6.7.6. Changing the Gateway Address (Static) .....	50	7.4.2. Start the LDU and Follow the Instructions .....	58
6.7.7. Querying the DHCP State .....	50	<b>7.5. KEEPING THE CONFIGURATION SETTINGS .....</b>	<b>61</b>
6.7.8. Changing the DHCP State.....	50	<b>8. TROUBLESHOOTING .....</b>	<b>62</b>
6.7.9. Enabling Ethernet Port .....	50	<b>9. TECHNOLOGIES.....</b>	<b>64</b>
<b>6.8. RS-232 PORT CONFIGURATION .....</b>	<b>51</b>	<b>9.1. EDID MANAGEMENT.....</b>	<b>64</b>
6.8.1. Querying the RS-232 Opearation Mode.....	51	9.1.1. Understanding the EDID .....	64
6.8.2. Setting the RS-232 Opearation Mode.....	51	9.1.2. Advanced EDID Management.....	64
6.8.3. Setting the BAUD Rate.....	51	<b>9.2. HDCP MANAGEMENT .....</b>	<b>65</b>
6.8.4. Setting the Databit.....	51	9.2.1. Protected and Unprotected Content .....	65
6.8.5. Setting the Stopbits .....	51	9.2.2. Disable Unnecessary Encryption.....	65
6.8.6. Setting the Parity .....	51	<b>9.3. PIXEL ACCURATE RECLOCKING .....</b>	<b>66</b>
6.8.7. Enabling Command Injection Mode .....	52	<b>9.4. SERIAL MANAGEMENT .....</b>	<b>67</b>
<b>6.9. SENDING MESSAGE VIA THE COMMUNICATION PORTS .....</b>	<b>52</b>	9.4.1. General Information .....	67
6.9.1. Sending Message via an RS-232 Port .....	52	9.4.2. Types of Serial Cables.....	67
6.9.2. Sending Message via TCP Port .....	52	9.4.3. RS-232 Signal Transmission over Lightware Extender Devices ..	67
6.9.3. Sending Message via UDP Port.....	53	<b>10. APPENDIX .....</b>	<b>68</b>
<b>6.10. EDID MANAGEMENT.....</b>	<b>54</b>	<b>10.1. SPECIFICATION .....</b>	<b>68</b>
6.10.1. Querying the Emulated EDIDs.....	54	<b>10.2. CONTENT OF BACKUP FILE.....</b>	<b>69</b>
6.10.2. Querying the Validity of a Dynamic EDID .....	54	<b>10.3. FACTORY DEFAULT SETTINGS .....</b>	<b>69</b>
6.10.3. Querying the Preferred Resolution of an User EDID.....	54	<b>10.4. MAXIMUM EXTENSION DISTANCES.....</b>	<b>70</b>
6.10.4. Emulating an EDID to an Input Port.....	54	<b>10.5. FACTORY EDID LIST .....</b>	<b>71</b>
6.10.5. Copying an EDID to User Memory .....	54	<b>10.6. MECHANICAL DRAWINGS .....</b>	<b>72</b>
6.10.6. Deleting an EDID from User Memory .....	54	10.6.1. HDMI20-OPTC-TX220-Pro .....	72
6.10.7. Resetting the Emulated EDIDs.....	54	10.6.2. HDMI20-OPTC-RX220-Pro .....	72
<b>6.11. LW3 COMMANDS - QUICK SUMMARY .....</b>	<b>55</b>	<b>10.7. FURTHER INFORMATION.....</b>	<b>73</b>

# 1

## Introduction

Thank You for choosing Lightware's HDMI20-OPTC series device. In the first chapter we would like to introduce the device highlighting the most important features in the below listed sections:

- ▶ DESCRIPTION
- ▶ MODEL DENOMINATION
- ▶ BOX CONTENTS
- ▶ COMPATIBLE DEVICES
- ▶ FEATURES OF THE DEVICE
- ▶ TYPICAL APPLICATION

### 1.1. Description

Thank You for choosing Lightware HDMI20-OPTC series products.

The HDMI20-OPTC-TX220-Pro and HDMI20-OPTC-RX220-Pro is a HDMI 2.0 compatible extender pair for video, RS-232 and Gigabit Ethernet signals, supporting uncompressed 4K UHD resolution at 60Hz 4:4:4. This extender pair is particularly recommended for rental and staging applications, 4K live events, and for future-proof operation centers. The extender can transmit HDMI 2.0 signals with 18Gbps over one multimode fiber to a distance of up to 700 meters.

Using the factory, custom or transparent EDID emulation the user can fix and lock EDID data on the HDMI connector. Advanced EDID Management forces the required resolution from any video source and fixes the output format conforming to the system requirements. The unit offers bi-directional and transparent RS-232 transmission and two separate Gigabit Ethernet signals over the fiber connection.

All devices can be mounted on a rack shelf or used standalone, rack ears also serve easy handling and bump protection, mounting threads on top and one of the sides to conform strict installation safety regulations.

### 1.2. Model Denomination

**HDMI20-OPTC-TX220-Pro**

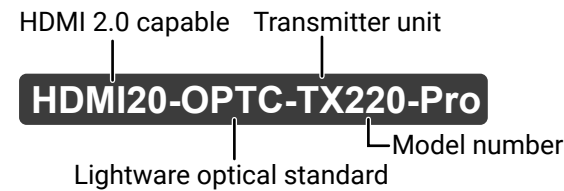

**HDMI20-OPTC-RX220-Pro**

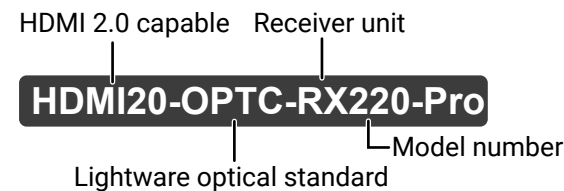

### 1.3. Box Contents

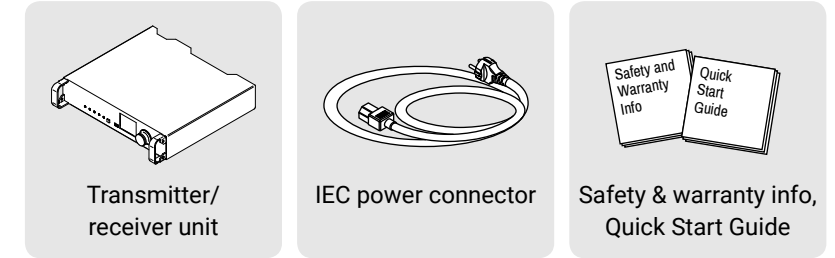

### 1.4. Compatible Devices

HDMI20-OPTC series devices are compatible with each other. For more information, please check the compatibility table on [www.lightware.com](http://www.lightware.com).

### 1.5. Features of the Device



#### 4K Video without Compression

Supporting uncompressed 4K UHD resolution at 60Hz 4:4:4 colorspace.



#### Signal Transmission up to 700m

Video, audio, Ethernet, RS-232 signal over fiber.



#### 18 Gbit/sec Bandwidth

The extender can transmit HDMI 2.0 signals with 18Gbps.

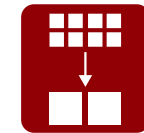

#### Conversion to 4:2:0

The receiver is able to subsample the video stream in YCbCr colorspace from 4:4:4 to 4:2:0.



#### HDMI 2.0 to 2x HDMI 1.4 Splitting

The device supports left and right column processing of an HDMI 2.0 4K@60Hz 4:4:4 input signal, allowing for the transmission of an 18 Gbps HDMI 2.0 signal over two HDMI 1.4 compliant links. The two halves can then be recombined at the signal destination.

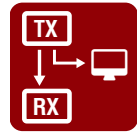

### Local Output

User can attach a local monitor to observe the video signal sent through the fiber optical cable. The resolution and clock frequency are the same on HDMI and fiber optical connectors, no internal scaling or conversion is applied.



### Graphic Display and Rotary Jog Dial Control Knob

Easy setting and menu navigation are assured by the color graphic display and the comfortable jog dial control.



### Event Manager

The Event Manager tool takes care of all the necessary control in a smaller configuration by performing predefined actions in response to device status changes. Hence, in a less complex environment, there is no need to invest in additional control solutions, which makes the receiver the best choice for numerous applications.



### Dark Mode

Rental application requires this function, which keeps the LEDs unlit to hide the device during the event.

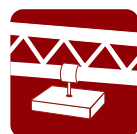

### Mounting Threads

Mounting threads on top and one of the sides to conform strict installation safety regulations.

## 1.6. Typical Application

- Rental and staging
- Long distance lossless HDMI or DVI signal transmission
- Professional AV systems, conference rooms

### 1.6.1. Integrated System Application

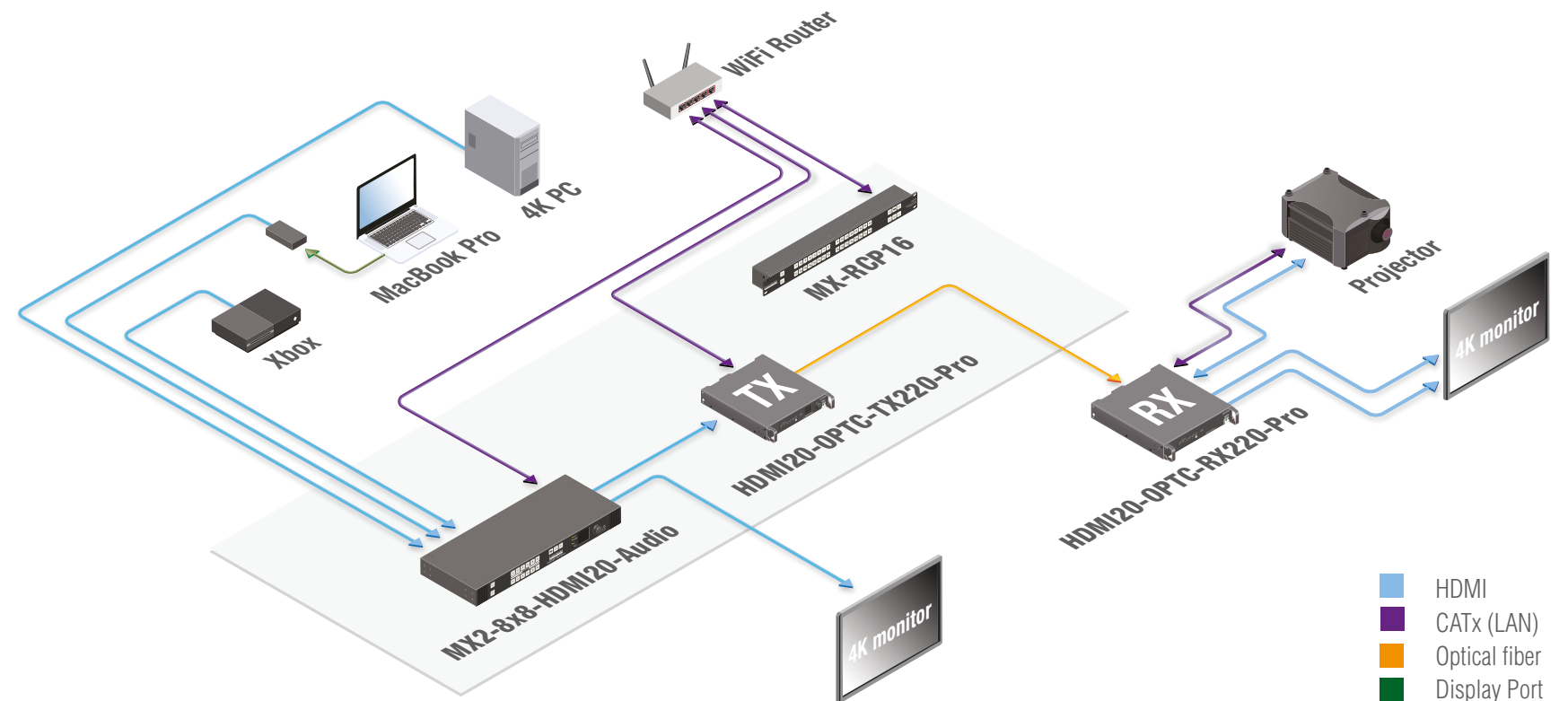

## 1.6.2. Standalone Application

### Typical Application Description

The two Ethernet connectors on each extender make possible to daisy chain the devices and build a local network where all the transmitters (1..3) and receivers (1..3) are available via LAN.

They can be controlled by Lightware Device Controller (LDC) software from the laptop. Optical fiber cable transmits the HDMI, embedded audio, Ethernet, and RS-232 signal to the receivers, so in this case, the sinks can be controlled by Ethernet commands from the control device (laptop).

In this example, all the sources send HDMI 2.0 4K@60Hz 4:4:4 A/V signal to the transmitters which extend the stream to the receivers via multimode fiber cable.

Receiver 1..3 represent three applications of the output modes:

- RX1 is in **transparent mode** (no conversion mode), the sinks are stacked projectors. The video signal is HDMI 2.0 4K@60Hz 4:4:4 on the Output 1A and the Output 2 ports.
- RX2 is in **downsample convert mode** (convert to YCbCr 4:2:0). The LED screen 2 is 4K compatible and connected to the Output 2 port. LED screen 1 is not HDMI 2.0 4K@60Hz 4:4:4 compliant, so the video processor in the receiver converts the HDMI signal from 4:4:4 to 4:2:0, and this way the sink will be able to accept the signal on the Output 1B.
- RX3 is in **split mode**. The receiver supports vertical splitting of the HDMI 2.0 4K@60Hz 4:4:4 input signal to left and right halves allowing for the transmission of a 18Gbps HDMI 2.0 signal over two HDMI1.4 compliant links. The sink is a projector which is able to recombine two half signals. Video signal is transmitted to the Output 2 without any changing.

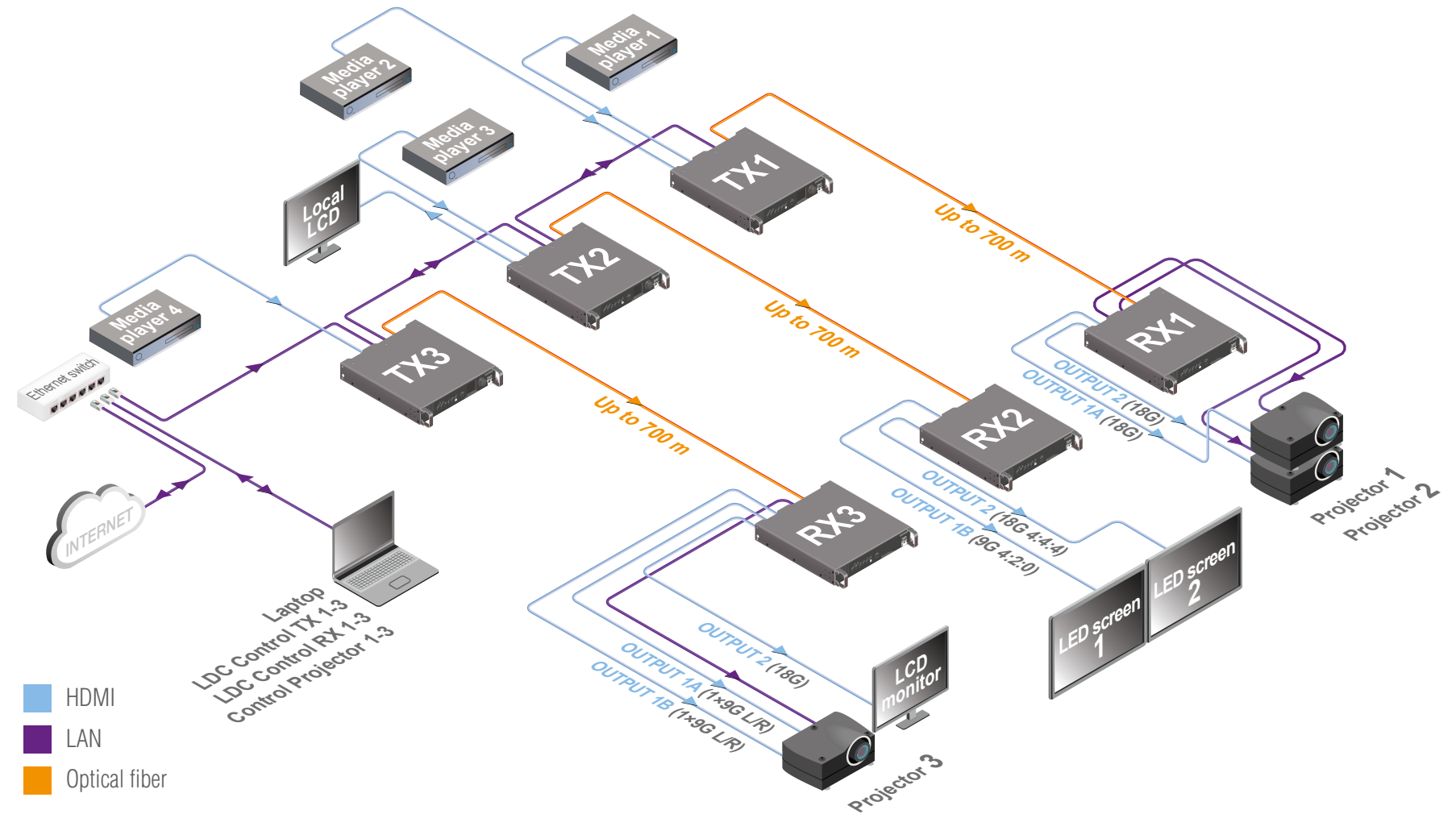



# 2

## Installation

The chapter is about the installation of the device and connecting to other appliances, presenting also the mounting options and further assembly steps:

- ▶ MOUNTING OPTIONS
- ▶ CONNECTING STEPS

### 2.1. Mounting Options

Extenders can be mounted in several ways, depending on the application. They can be mounted on a rack shelf or used standalone. Rack ears also serve easy handling and bump protection, mounting threads on top and one of the sides to conform strict installation safety regulations.

**ATTENTION!** To ensure the correct ventilation and avoid overheating let enough free space in front of the appliance and keep the ventilation holes free.

#### 2.1.1. Truss Mounting - HDMI20-OPTC-RX220-Pro

Mounting thread on top and on one of the sides for safe and secure installation. Rigging the handles with a safety wire rope is highly recommended for safety reasons.

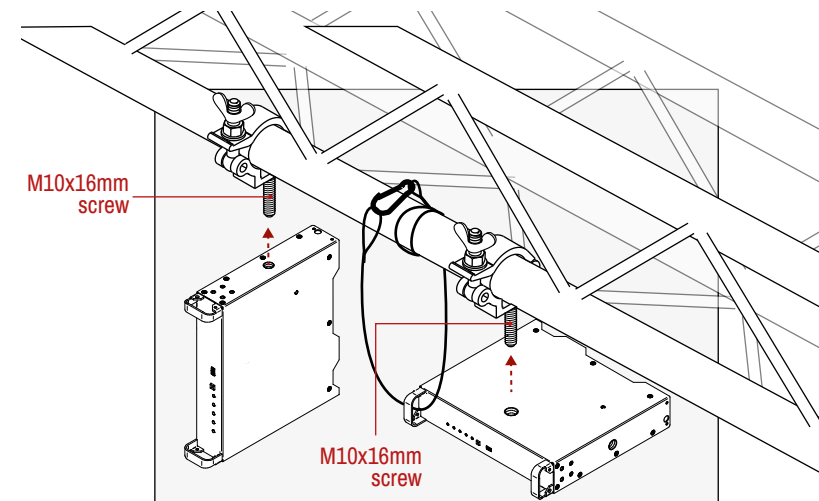

To order mounting accessories please contact [sales@lightware.com](mailto:sales@lightware.com). (Truss clamp and safety wire rope are not available at sales.)

#### 2.1.2. Standard Rack Installation

Rack mounting kit includes all necessary accessories for [Standard Rack Installation](#):

- 2 pcs. rack ears,
- 12 pcs. black, M4x8mm hexagon socket countersunk head screws.

Rack mounting kit is not supplied with the product, it can be purchased separately, please contact [sales@lightware.com](mailto:sales@lightware.com).

**Step 1.** Take two devices directly each other.

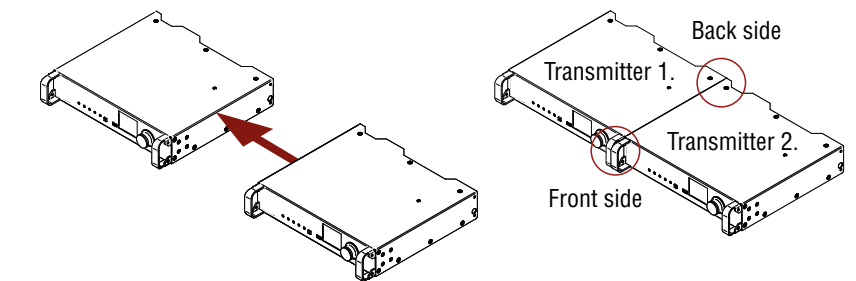

**Step 2.** Two mounting holes on the front ears and two on the back of the chassis is for fastening the two units to each other with 2x 2 pcs. M4x8 mm screws. This way you get a one-rack wide and 1U high device.

**Front side**

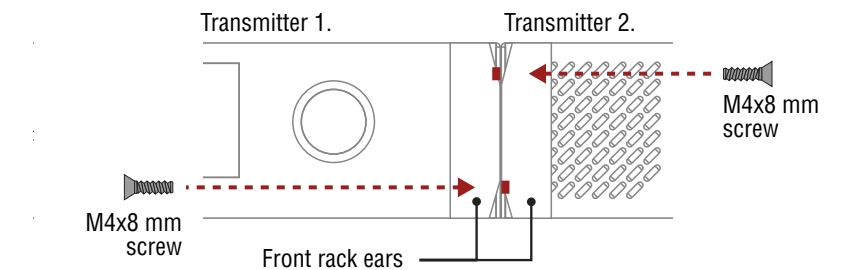

**Back side**

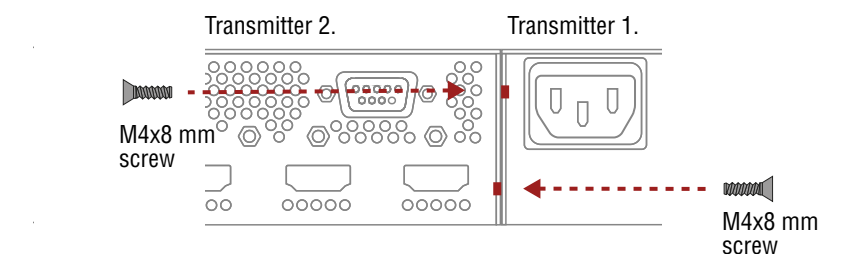

**ATTENTION!** Take care of the mounting direction of the screws!

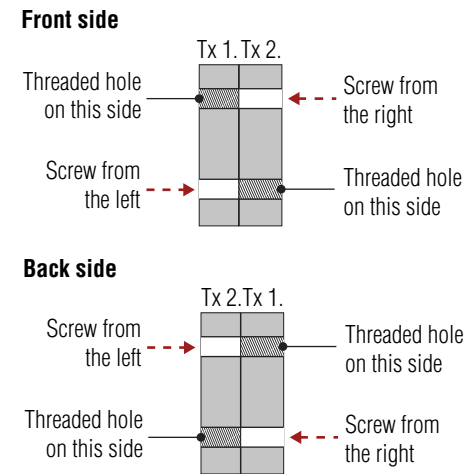

**Mounting direction of the screws**

**Step 3.** Take the rack ears on the left and right side of the extender pair as shown in the picture. Insert the screws into the holes and fix the front ears to the devices.

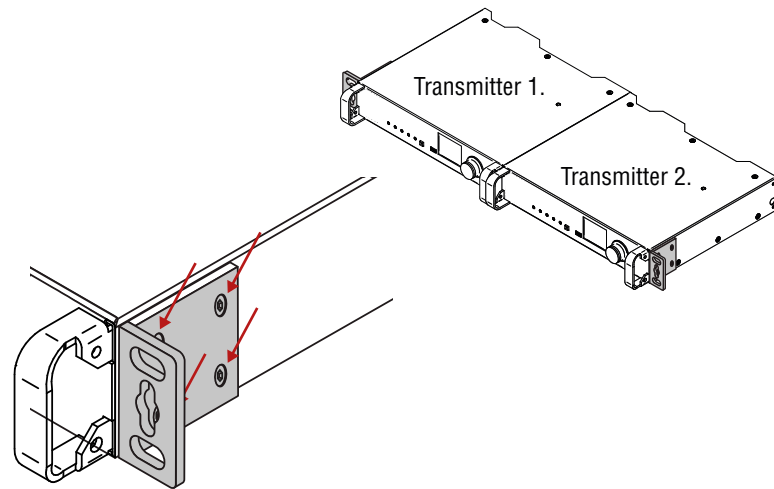

**Assembly of the mounting ears**

**Step 4.** As a final step, mount the unit in the rack.

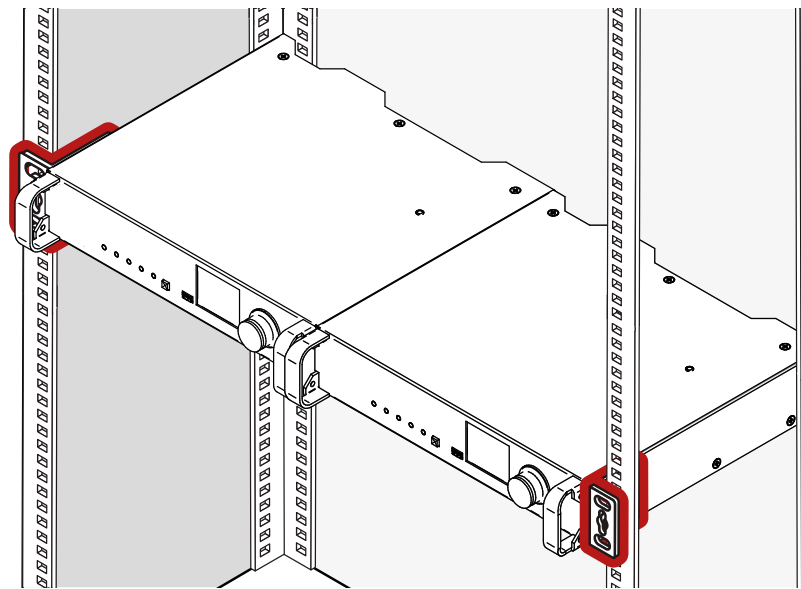

**Standard rack installation**

**ATTENTION!** Always use all the four screws for fixing the rack ears to the rack rail. Choose properly sized screws for mounting. Keep minimum two thread left after the nut screw.

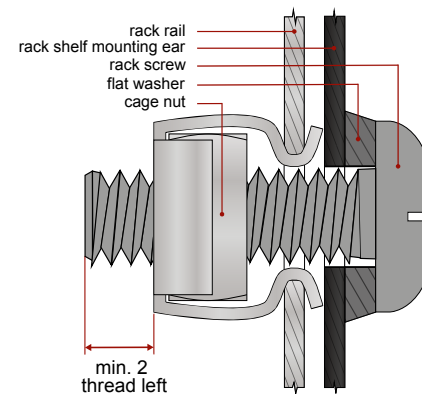

**Mounting the rack ears to the rack rail**

**2.1.3. Rack Shelf Mounting (with 1U high Rack Shelf)**

1U high rack shelf provides mounting holes for fastening two 1/2-rack or four 1/4-rack size units. Supplied accessories:

- 10 pcs. PZ flat head screw (M3x6mm).

Rack shelf is not supplied with the product, it can be purchased separately, please contact [sales@lightware.com](mailto:sales@lightware.com).

**Step 1.** Turn the unit upside down.

**Step 2.** Put the rack shelf upside down on the unit, and position it to get the mounting holes aligned.

**Step 3.** Fasten the unit on the rack shelf with the provided screws.

**Step 4.** Mount the rack shelf in the rack.

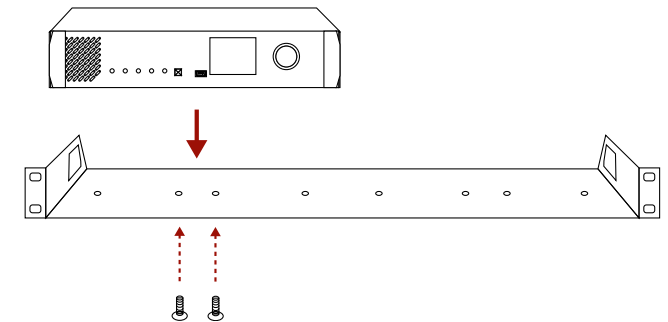

**INFO:** The extender is half-rack sized.

## 2.2. Connecting Steps

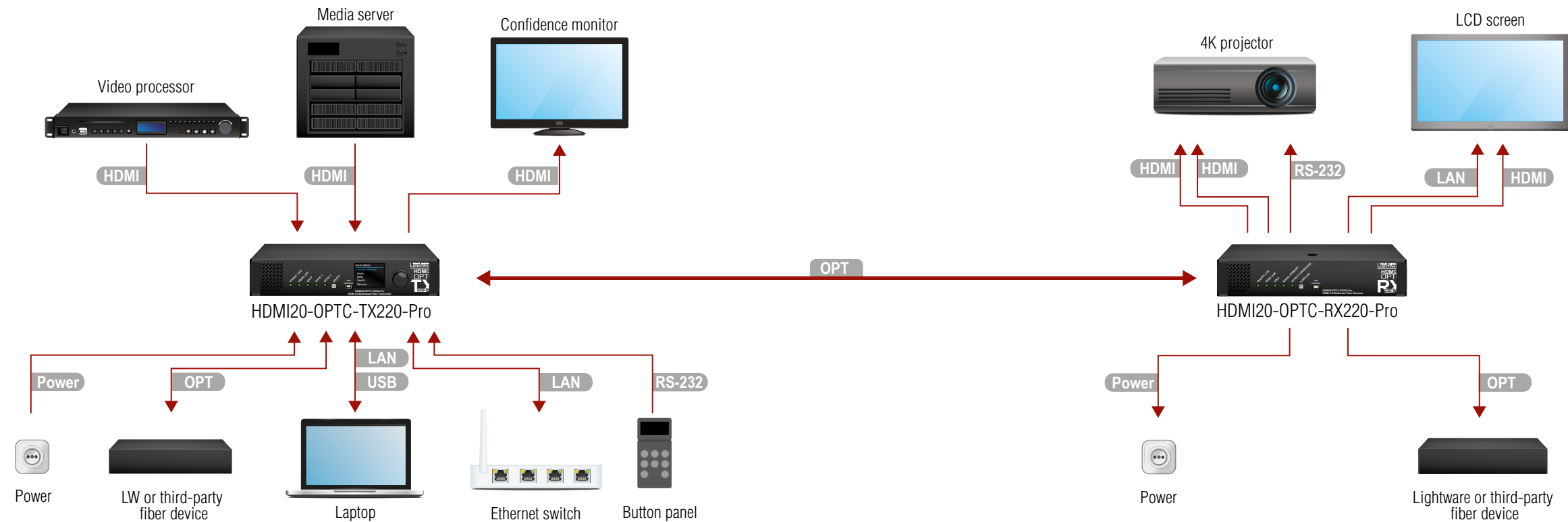

- OPT** Connect a multimode (MM) fiber cable to the channel A of the transmitter.
- OPT** Optionally connect a compatible Lightware device or a third-party device to the break-out LC connector. It is internally linked to the channel B of the Neutrik connector.
- HDMI** Connect an HDMI source (e.g. video processor or media server) to any of the inputs of the transmitter.
- HDMI** Optionally connect an HDMI sink (e.g. confidence monitor) to the HDMI output of the transmitter. The displayed signal of the output port is equal to the extended video signal.
- LAN** Optionally connect Ethernet devices (e.g. switch, laptop, computer etc.) to the available Neutrik etherCON connector(s) of the extender(s). All connected devices will work as if they are connected to the same network. Ethernet connectors are not Power over Ethernet (PoE) compatible.
- USB** Optionally connect a USB mini-B type cable between the transmitter unit and the computer in order to control the device (in this case only the transmitter).
- RS-232** Optionally for RS-232 extension: connect a controller unit (e.g. button panel) to the RS-232 port of the transmitter with a null modem serial cable.
- Power** Connect the power cord to the AC power socket to the transmitter unit. It is recommended to power on the devices as the final step.

- OPT** Connect a multimode (MM) fiber cable to the channel B of the receiver.
- OPT** Optionally connect a compatible Lightware device or a third-party device to the break-out LC connector. It is internally linked to the channel A of Neutrik connector.
- HDMI** Connect an HDMI sink (e.g. 4K projector) to the HDMI 1A and the 1B output ports and the other sink (e.g. LCD screen) to the HDMI 2 output port.
- LAN** In order to control, optionally connect Ethernet devices (e.g. 4K LCD screen) to the available Neutrik etherCON connector of the extender.
- RS-232** Optionally for RS-232 extension: connect a controlled device (e.g. projector) to RS-232 port of the receiver with a serial cable.
- Power** Connect the power cord to AC power socket to the receiver unit. It is recommended to power on the devices as the final step.

**ATTENTION!** Connecting the transmitter and receiver to the same LAN beside they are connected to each other via fiber is not recommended. In case of Ethernet loop, the extenders are not available via LAN.

**ATTENTION!** Always use high-quality HDMI cable for connecting the sources with the transmitters, and sinks with the receivers.

# 3

## Product Overview

The following sections are about the physical structure of the device, input/output ports, and connectors:

- ▶ FRONT VIEW
- ▶ REAR VIEW
- ▶ ELECTRICAL CONNECTIONS
- ▶ MULTIMODE SINGLE FIBER EXTENDER CONCEPT
- ▶ OPTICAL INTERFACE
- ▶ VIDEO AND AUDIO INTERFACE
- ▶ CONTROL FEATURES

### 3.1. Front View

#### HDMI20-OPTC-TX220-Pro

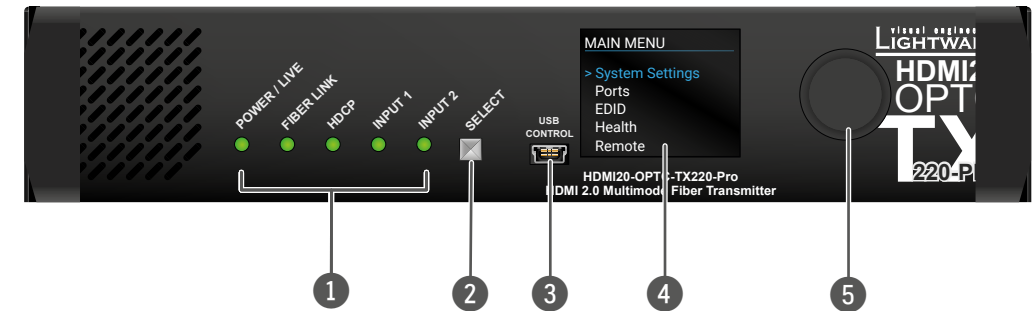

#### HDMI20-OPTC-RX220-Pro

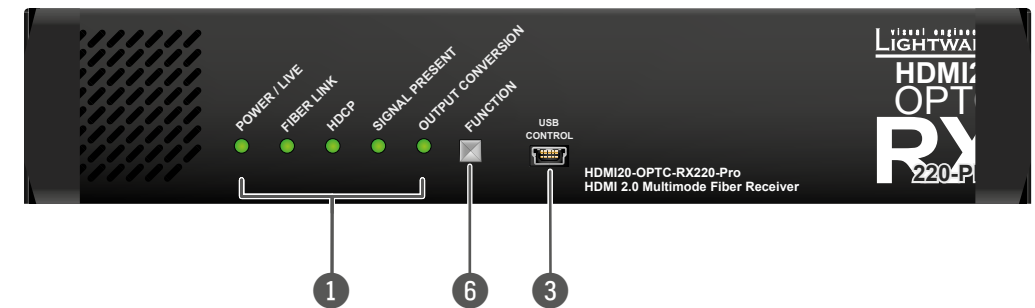

- 1 Status LEDs** The LEDs give feedback about the state, connections and certain settings of the unit. For details, see [Status LEDs - Transmitter](#) and [Status LEDs - Receiver](#) section.
- 2 Select button** **Transmitter:** Select button toggles between the Input 1 and Input 2.
- 6 Function button** **Receiver:** Function button sets the output conversion mode. See the details in [Output Conversion Modes](#) section.
- 3 USB Port** USB mini-B port for local controlling the unit by Lightware Device Controller software.
- 4 LCD display** **Transmitter:** Display of the front panel menu.
- 5 Jog dial knob** **Transmitter:** Browse the menu by turning the knob, click on the desired item to check or change it.

## 3.2. Rear View

### HDMI20-OPTC-TX220-Pro

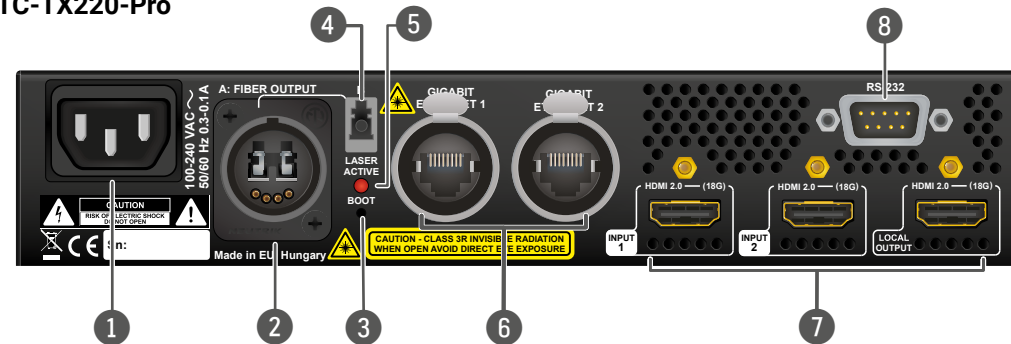

### HDMI20-OPTC-RX220-Pro

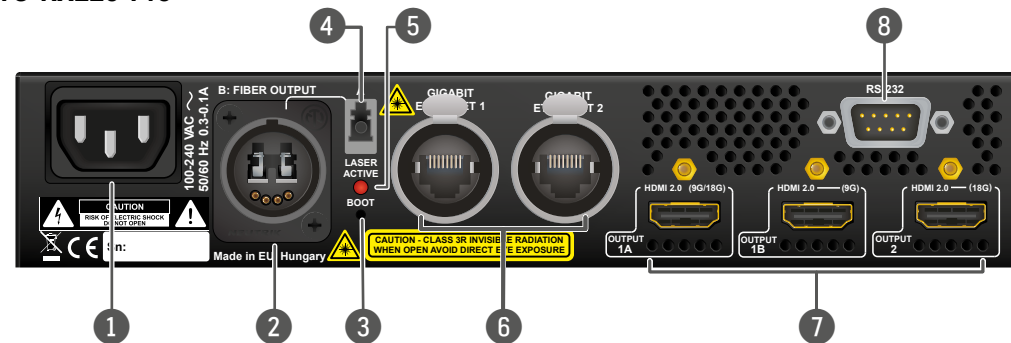

- 1 **AC connector** Standard IEC connector accepting 100-240 V, 50 or 60 Hz.
- 2 **Fiber connector** Neutrik opticalCON DUO LC connector for optical data transmission. The **channel A** carries the signal from the transmitter to **channel B** in the receiver.
- 3 **Boot button** Hidden button for special bootload function.
- 4 **Break-out connector** The break-out LC connector is internally connected to the **channel B** of Neutrik connector in the transmitter and the **channel A** in the receiver. It is to carry any optical signal from the break-out LC connector.
- 5 **Laser LED** It gives feedback about the operation of the optical module. When the laser is active (Laser LED is ON), it radiates invisible waves from the optical connector. Avoid eye exposure to beam!
- 6 **LAN** Two Neutrik etherCON connectors for Gigabit Ethernet (to control the unit or for pass-through). Both are in the same local network. Remote powering (PoE) is not possible.
- 7 **HDMI connector** **Transmitter:** Two HDMI 2.0 input ports and one HDMI 2.0 output port for local display. **Receiver:** Three HDMI video output ports.
- 8 **Serial port** D-SUB connector for bidirectional RS-232 communication (control/command injection/pass-through mode).

## 3.3. Electrical Connections

### Fiber Connector

HDMI20-OPTC-TX220-Pro and HDMI20-OPTC-RX220-Pro transmit the video, embedded audio, Ethernet, and serial signal using multimode 50/125 fiber optical cable. Neutrik opticalCON connector (NO2-4FDW type LC duplex) and LC ODVA connector have two fiber channels, channel A and channel B. Only one channel is used (from channel A on the transmitter to channel B on the receiver). The copper pins of the Neutrik connector are not in use. Neutrik opticalCON DUO is compatible with 2x LC connector.



**WARNING! Avoid eye exposure to beam! Direct intrabeam viewing normally hazardous.**

INFO: Fiber optic cables can be easily damaged if they are improperly handled or installed. Handle the optical cables with care to avoid damage.

### LC Connector

One channel of the Neutrik connector is not used by the extenders for signal transmission and it is internally connected to the LC break-out connector. For more information about break-out connector see [Application Example with Break-out Connector](#) section.



### HDMI Input and Output Ports

The extender provides standard 19-pole HDMI connector with screw lock.

**ATTENTION!** Always use high-quality HDMI cable for connecting sources and displays.



### Ethernet (LAN) Port

HDMI20-OPTC series extenders are supplied Neutrik etherCON connector for Ethernet/LAN connection. The Ethernet port can be connected to a LAN hub, switch or router by a CATx cable. However, both cable types (straight or cross) are supported and handled by the device, below pin assignment is recommended.

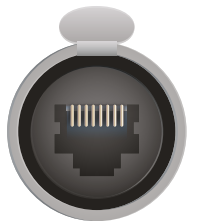

Pin	TIA/EIA T568 A	Color and name	TIA/EIA T568 B	Color and name
1		white/green stripe		white/orange stripe
2		green solid		orange solid
3		white/orange stripe		white/green stripe
4		blue solid		blue solid
5		white/blue stripe		white/blue stripe
6		orange solid		green solid
7		white/brown stripe		white/brown stripe
8		brown solid		brown solid

**USB Connector**

HDMI20-OPTC series have standard USB mini-B receptacle.

**RS-232 Port**

The extenders have RS-232 pass-through function or can be remote controlled through industry standard 9-pole D-SUB male connector.

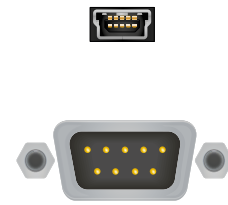

D-sub connector pin assignment for standard RS-232	
Pin nr.	Pinout
1	NC - non-connected
2	RX data receive (input)
3	TX data transmit (output)
4	DTR (Internally connected to Pin 6)
5	GND signal ground (shield)
6	DSR (Internally connected to Pin 4)
7	RTS (Internally connected to Pin 8)
8	CTS (Internally connected to Pin 7)
9	NC - non-connected

INFO: HDMI20-OPTC-TX/RX220-Pro is DTE unit according to its pin-out. For more information see [Serial Management](#) section.

INFO: Factory default settings are the same in the transmitter and receiver: 57600 Baud, 8 bit, 1stop bit, no parity.

**3.4. Multimode Single Fiber Extender Concept**

HDMI20-OPTC-TX220-Pro and HDMI20-OPTC-RX220-Pro are a HDMI 2.0 compatible single fiber extender pair. They are able to transmit digital video, embedded audio, RS-232 and Gigabit Ethernet signals via multimode optical cable up to 700m. They are designed for rental purposes, supporting uncompressed 4K UHD resolution at 60Hz at 4:4:4 colorspace.

The extenders use only one channel of Neutrik optiCON duo cable, and the other channel is internally connected to break-out connector. See details about in [Application Example with Break-out Connector](#) section.

**3.4.1. Summary of Interfaces - Transmitter**

- Inputs:**
- HDMI →
  - Ethernet 2x →
  - RS-232 →
  - OPTC (break-out) →

- + Control Interfaces:**
- USB



- Outputs:**
- OPTC
    - HDMI
    - Ethernet
    - RS-232
  - HDMI

**3.4.2. Summary of Interfaces - Receiver**

- Inputs:**
- HDMI →
  - Ethernet →
  - RS-232 →
  - OPTC →

- + Control interfaces:**
- USB

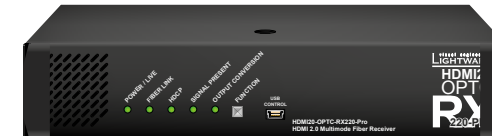

- Outputs:**
- HDMI
  - Ethernet 2x
  - RS-232
  - OPTC (break-out)

### 3.5. Optical Interface

HDMI20-OPTC extenders support multimode fiber optical interface to transmit or receive digital video, embedded audio, RS-232 and Ethernet signals. For more details about the supported cable extension distances see [Maximum Extension Distances](#) section.

#### Port Diagram of Optical Interface

The Neutrik opticalCON DUO cable has two fiber channels, named **channel A** and **channel B**. Since Lightware fiber extenders use only one fiber for signal transmission, the other fiber can be used by other optical devices. The unused fiber channel is accessible by the break-out connector.

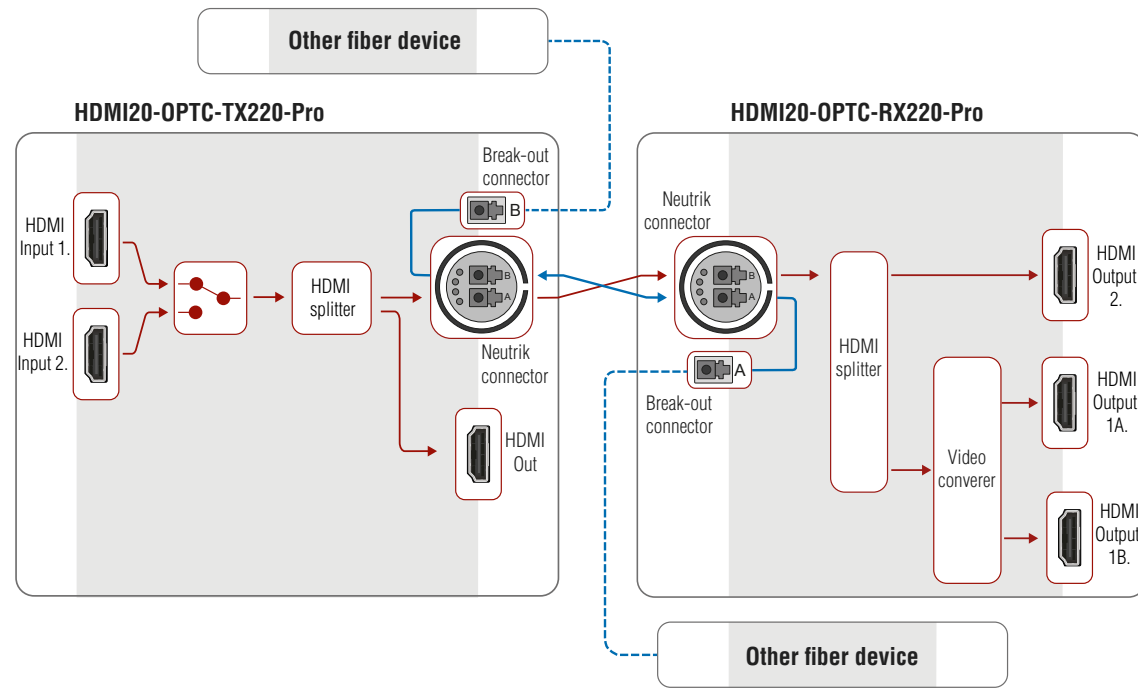

INFO: Red line shows the main direction of the video signal. The blue line represents the optical signal via break-out connector, which direction is not specified.

#### Application Example with Break-out Connector

Using this feature, it is possible to transmit two different A/V signal from one transmitter pair to another receiver pair with only one Neutrik opticalCON DUO cable. See the application example below.

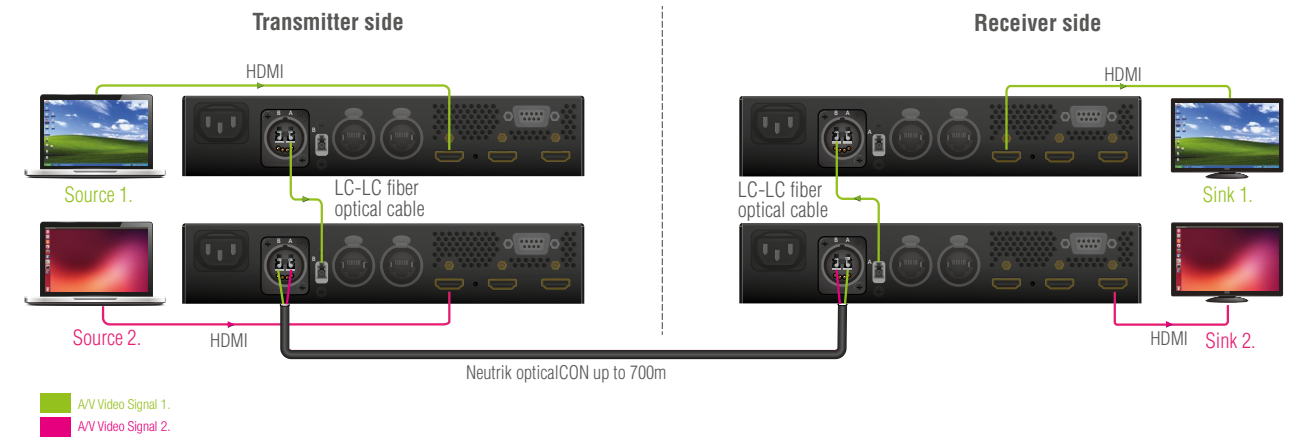

#### Transmitter Unit (HDMI20-OPTC-TX220-Pro)

The transmitter's laser driver sends the signal through **Channel A**. **Channel B** is directly connected to the break-out connector with a fiber optical cable inside the unit. Any optical signal can be transferred through this channel in any direction.

#### Receiver Unit (HDMI20-OPTC-RX220-Pro)

The receiver's laser sensor gets the signal through **Channel B**. **Channel A** is directly connected to the break-out connector with a fiber optical cable inside the unit. Any optical signal can be transferred through this channel in any direction.

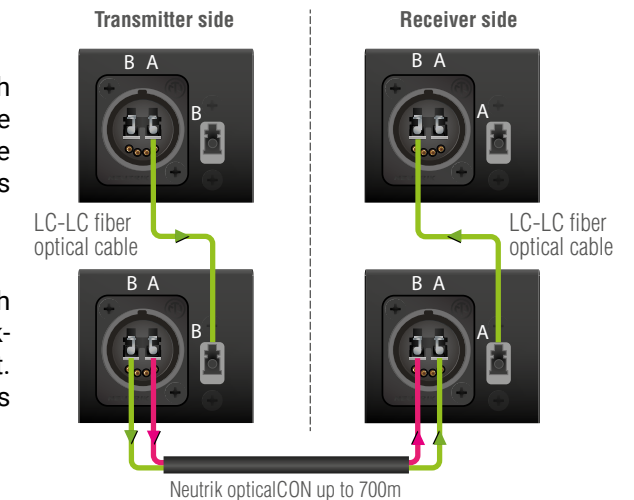

### 3.6. Video and Audio Interface

The HDMI20-OPTC series transmitter can receive signal from two types of sources:

- DVI-D
- HDMI (with embedded audio)

The HDMI20-OPTC series receiver can output HDMI video signal (with embedded audio).

#### Port Diagram of Video and Audio Interface

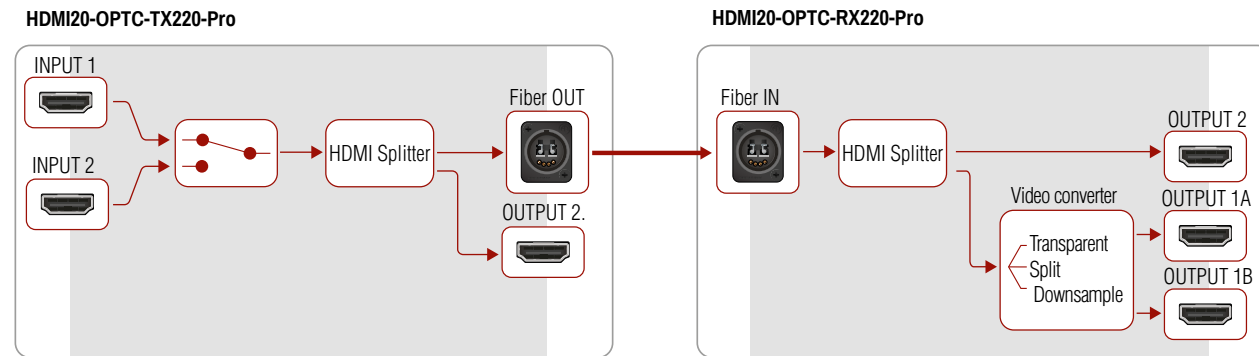

#### Transmitter Side

The video signal is received at the Input 1 or the Input 2. The HDMI splitter duplicates the signal and sends the same HDMI stream to the local HDMI output and the fiber output.

#### Receiver Side

The video and the embedded audio signal arrives via optical cable into the HDMI splitter. It duplicates HDMI stream and transmits the signal without modifying it to the HDMI Out 2 port. The HDMI splitter transmits the same signal into the video converter where three output conversion modes can be set.

#### 3.6.1. Output Conversion Modes

Conversion modes refer to the receiver side and this property can be set in the front panel menu of the transmitter (see [Conversion Submenu](#)), available in the Lightware Device Controller Software (see [HDMI Output Port - Receiver](#)) and also in the LW3 tree, both the transmitter and the receiver.

In **Transparent mode** (no conversion mode), the video signal is transmitted to the HDMI Output 1A and the HDMI Output 1B without any changing.

INFO: Maximal data transmission capacity of Output 1B is 9 Gbps, if the video signal is above this bandwidth, there will be no picture on the display.

**Split mode** means splitting of the original video signal into left and right halves and sending the split signal to the HDMI Output 1A and the HDMI Output 1B.

In **Downsample convert mode** (convert to YCbCr 4:2:0) the video converter subsamples the 4:4:4 signal to 4:2:0 on the 1A and 1B Output port.

INFO: Split and downsample convert modes are available at maximum 8-bit color depth.

#### 3.6.2. Autoselect Feature

Besides manual crosspoint selection you can choose the Autoselect option on the video ports. There are three types of Autoselect as follows:

- **First detect mode:** selected input port is kept connected to the output while it has an active signal
- **Priority detect mode:** always the highest priority active input is selected to transmit.
- **Last detect mode:** always the last attached input is selected to transmit.

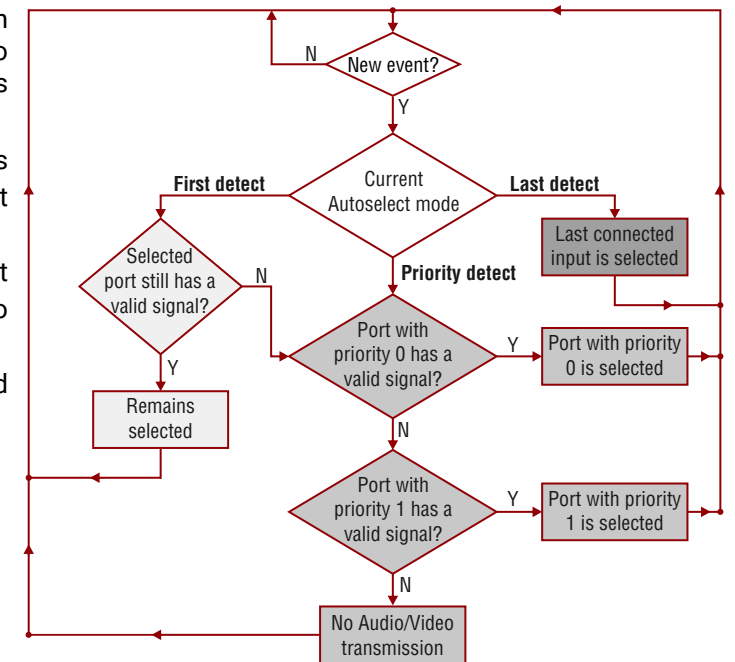

#### Video Interface - Example

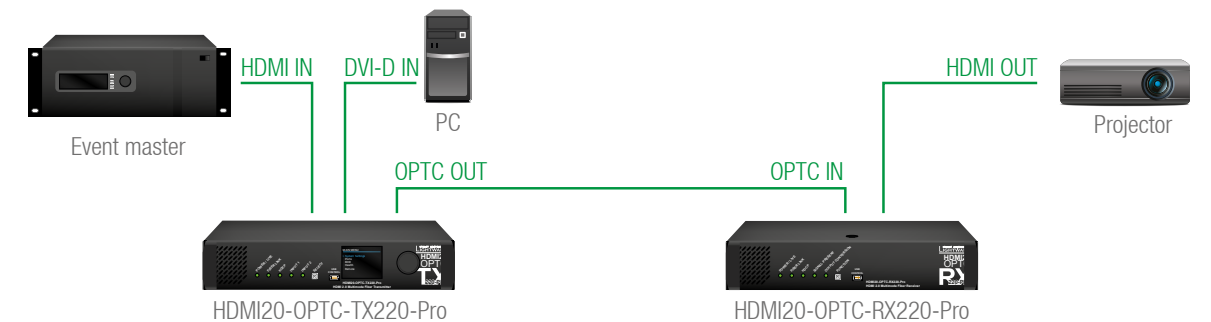

#### The Concept

The HDMI signal with embedded audio comes from the Event master to Input 1. The other source is a PC, which sends DVI-D signal to Input 2. Both of them are connected to the transmitter, where the autoselect mode is enabled with priority 0 on the Input 1, so the Input 1 is selected.

INFO: Only one input can be selected at the same time.



### 3.7. Control Features

The devices can be controlled over Ethernet, USB, and RS-232 ports as well. The following sections are about to describe the available features and settings by these interfaces.

#### 3.7.1. USB Control Interface

The device can be controlled over front panel USB port (mini B-type connector). This interface supports LW3 protocol. The interface can be used to establish a connection to Lightware Device Controller software.

**INFO:** USB control operates locally, USB data is not transmitted via optical cable between the transmitter and the receiver.

#### 3.7.2. Ethernet Interface

The device can be controlled via Ethernet port (Neutrik etherCON connector). This interface supports any third-party system controller with LW3 command protocol. The interface can be used to configure the device with Lightware Device Controller and establish the connection to Lightware Device Updater software and perform firmware upgrade.

Two Neutrik etherCON connectors provide a wide range of application possibilities:

- Control the device
- Firmware upgrade
- Create a local network
- Daisy chain connection

#### Port Diagram of Ethernet Interface

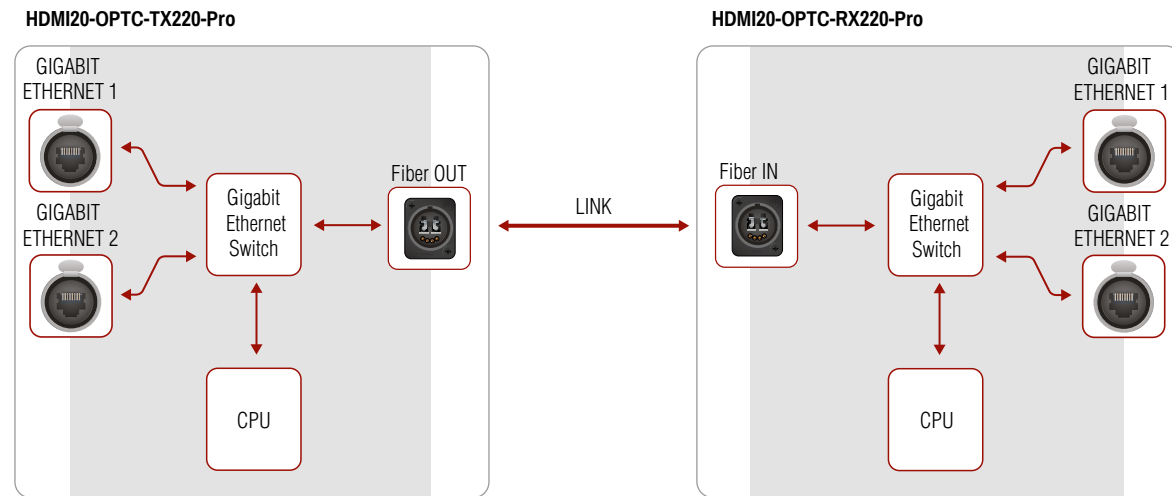

#### Ethernet Interface - Example



**Transmitters** are connected to each other via LAN, the **receivers** connected to the **transmitters** via optical fiber and all the **projectors** connected to the **receivers** via LAN.

This way the **Laptop** can control the system with Ethernet commands:

- HDMI20-OPTC.TX220-Pro (1-3).
- HDMI20-OPTC.RX220-Pro (1-3).
- Projector (1-6).

### 3.7.3. Serial Interface

INFO: HDMI20-OPTC-TX/RX220-Pro are DTE unit according to their pin-out. For more details about pin assignment see [RS-232 Port](#) section.

Serial data communication can be established via local RS-232 port (D-SUB male connector). Three different RS-232 modes can be set for the serial port: pass-through mode, control mode, command injection mode, see the figure below.

#### Port Diagram of Serial Interface

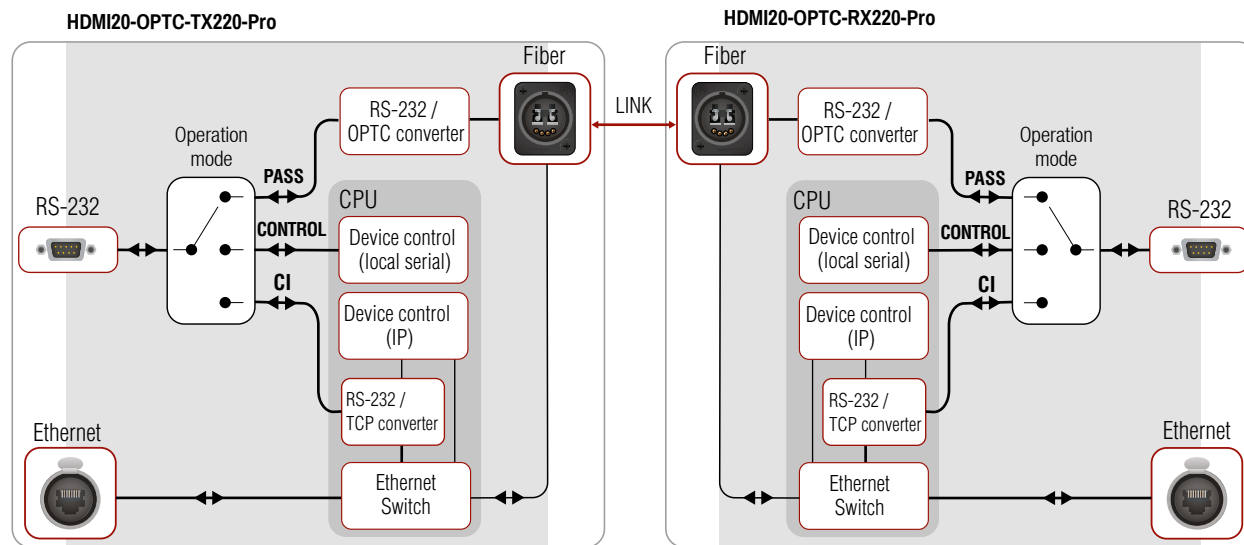

The following operation modes are defined:

- **PASS:** The local serial port is in **Pass-through mode**.
- **CONTROL:** The local serial port is in **Control mode**.
- **CI:** The local serial port is in **Command Injection mode**.

#### Pass-through Mode

In pass-through mode, the given device forwards the data that is coming from one of its ports to another same type of port. The command is not processed by the CPU. Incoming serial data is forwarded from one port to another port.

**ATTENTION!** Both the transmitter and the extender have to be set **Pass-through mode**, in case of sending RS-232 commands from the TX side to the third party device on the RX side.

#### Control Mode

The incoming data from the given local port is processed and interpreted by the CPU. The mode allows to control the extender directly. LW3 protocol commands are accepted.

#### Command Injection Mode

In this mode, the extender works as a TCP/IP <-> RS-232 bidirectional converter. The TCP/IP data signal is converted to RS-232 data and vice versa. TCP/IP port numbers are defined for the serial ports for this purpose. E.g. the default Command Injection port number of the local RS-232 port is 8001.

INFO: The commands in this mode not transmitted via fiber, they operates between the local ports.

#### RS-232 Signal Transmission - Example 1

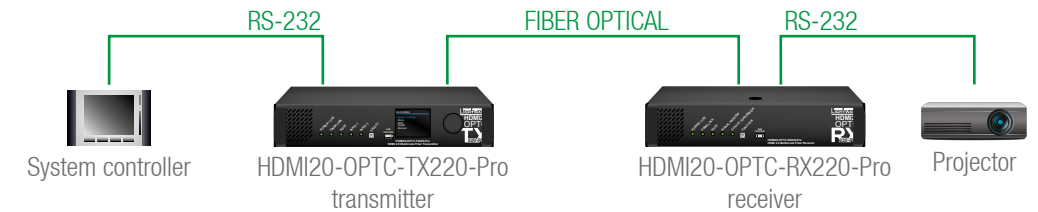

#### The Concept

You can control the **Projector** over the extenders with the **System controller**. The controller is connected to the local RS-232 port of the **Transmitter** which transmits the signal toward the **Receiver** over the fiber optical line. The **Projector** is connected to the local RS-232 port of the **Receiver**. The serial connection is bidirectional which means the controller gets back the responses of the projector.

In this case the RS-232 port of the transmitter and receiver has to be set to **Pass-through mode**.

# 4

## Operation

This chapter is about the powering and operating of the device describing the functions which are available by the front/rear controls:

- ▶ [POWERING ON](#)
- ▶ [FRONT PANEL OPERATIONS](#)
- ▶ [FRONT PANEL LCD MENU OPERATIONS](#)

### 4.1. Powering on

Connect the power cord to the AC input connector; the extender is immediately powered on. After the self-test, the last configuration is loaded automatically.

### 4.2. Front Panel Operations

**ATTENTION!** When Dark mode is enabled, no LEDs are on, even though the device is fully functional.

#### Status LEDs - Transmitter

POWER/LIVE			FRONT
	green	blinking	The transmitter unit is powered and ready to use.
	green	on	The transmitter unit is out of operation.
		off	The transmitter unit is NOT powered or out of operation.
FIBER LINK			FRONT
	green	on	The connection is established between the transmitter and the receiver and they can communicate to each other.
		off	When the TX and RX are not connected.
	yellow	blinking	It shows connection error in the RX and TX.
HDCP			FRONT
	green	on	Video signal is HDCP-encrypted.
		off	There is no HDCP encryption in the video signal.
	yellow	blinking	It shows HDCP error.
INPUT1, INPUT2			FRONT
	green	on	This port is selected and there is a valid video signal on it.
	green	blinking	When the port is selected and there is no valid video signal on it.
	yellow	on	When the port is not selected, but there is a valid video signal on it.
		off	This port is not selected and there is no signal on it.
LASER ACTIVE			REAR
	red	on	It gives feedback about the operation of the optical module, that means the laser radiates invisible waves. Avoid direct eye contact with the optical connectors!
		off	Laser module is not active.

#### Status LEDs - Receiver

POWER/LIVE			FRONT
	green	blinking	The receiver unit is powered and ready to use.
		off	The receiver unit is NOT powered or out of operation.
FIBER LINK			FRONT
	green	on	The connection is established between the transmitter and the receiver and they can communicate to each other.
		off	When the TX and RX are not connected.
	yellow	blinking	It shows connection error in the RX and TX.
HDCP			FRONT
	green	on	Video signal is HDCP-encrypted.
		off	There is no HDCP encryption in the video signal.
	yellow	blinking	It shows HDCP error.
SIGNAL PRESENT			FRONT
	green	on	Valid video signal is present.
		off	No video signal is present.
	yellow	blinking	It shows error in the video signal transmission.
OUTPUT CONVERSION			FRONT
	green	on	Split mode is active.
		off	Transparent mode (no conversion) is active.
	yellow	on	Downsample convert (convert to YCbCr 4:2:0) mode is active.
LASER ACTIVE			REAR
	red	on	It gives feedback about the operation of the optical module, that means the laser radiates invisible waves. Avoid direct eye contact with the optical connectors!
		off	Laser modul is not active.

**INFO:** When LEDs blink green three times after clicking on the Input/Function button, they show that the front panel lock is enabled.

#### 4.2.1. Function Button - HDMI20-OPTC-TX220-Pro

 Select button is for switching between the Input 1 and the Input 2. Autoselect mode can not be activated by pushing the **Select** button, but this function can be disabled by choosing Input 1 or Input 2 with the **Select** button.

INFO: Autoselect mode can be set with Lightware Device Controller software (see [HDMI Output Port - Transmitter](#) and [Optical Output Port - Transmitter](#) section) or with protocol commands (see [Changing the Autoselect Mode](#) section).

##### Enable Dynamic (DHCP) IP Address

The device gets a static IP address as a factory default setting. If this setting does not fit to the circumstances during install or usage, DHCP\* can be enabled from the front panel:

- Step 1.** Make sure the device is powered on and operational.
- Step 2.** Press and keep pressed the **Select** button for 5 seconds.
- Step 3.** After 5 seconds front panel LEDs start blinking; release the button and press it 3 times again quickly (within 1,5 seconds).
- Step 4.** The LEDs get dark, DHCP gets enabled.
- Step 5.** As a final step, device restarts and is available with the new IP address.

\* Static IP address also can be modified. This setting is available on the front panel menu or in Lightware Device Controller software.

##### Restore Factory Default Settings

To restore factory default values, do the following steps:

- Step 1.** Make sure the device is powered on and operational.
- Step 2.** Press and keep pressed the **Select** button for 10 seconds. After 5 seconds front panel LEDs start blinking but keep on pressing the button.
- Step 3.** After 5 seconds the blinking gets faster; release the button and press it 3 times again quickly (within 1,5 seconds).
- Step 4.** The LEDs get dark, the device restores the factory default settings and reboots.

Factory default settings are listed in the [Factory Default Settings](#) section.

#### 4.2.2. Boot Button

Hidden button for special bootloader function. Use only for the particular request of the Lightware Support Team.

#### 4.2.3. Function Button - HDMI20-OPTC-RX220-Pro

 Function button sets the output conversion mode. See details about these modes in [Output Conversion Modes](#) section.

##### Enable Dynamic (DHCP) IP Address

The device gets a static IP address as a factory default setting. If this setting does not fit to the circumstances during install or usage, DHCP can be enabled from the front panel:

- Step 1.** Make sure the device is powered on and operational.
- Step 2.** Press and keep pressed the **Function** button for 5 seconds.
- Step 3.** After 5 seconds front panel LEDs start blinking; release the button and press it 3 times again quickly (within 1,5 seconds).
- Step 4.** The LEDs get dark, DHCP gets enabled.
- Step 5.** As a final step, device restarts and is available with the new IP address.

\* Static IP address also can be modified. This setting is available on the front panel menu or in Lightware Device Controller software.

##### Restore Factory Default Settings

To restore factory default values, do the following steps:

- Step 1.** Make sure the device is powered on and operational.
- Step 2.** Press and keep pressed the **Function** button for 10 seconds. After 5 seconds front panel LEDs start blinking but keep on pressing the button.
- Step 3.** After 5 seconds the blinking gets faster; release the button and press it 3 times again quickly (within 1,5 seconds).
- Step 4.** The LEDs get dark, the device restores the factory default settings and reboots.

Factory default settings are listed in the [Factory Default Settings](#) section.

#### 4.2.4. Boot Button

Hidden button for special bootloader function. Use only for the particular request of the Lightware Support Team.

### 4.3. Front Panel LCD Menu Operations

The front panel has a color LCD that shows the most important settings and parameters structured in a menu. The jog dial control knob can be used to navigate between the menu items or change the value of a parameter. The knob can be pressed to enter a menu or edit/set a parameter.

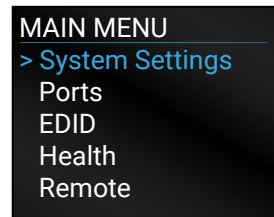

Menu navigation & change parameter

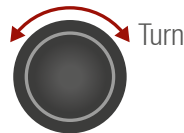

Menu selection & set parameter

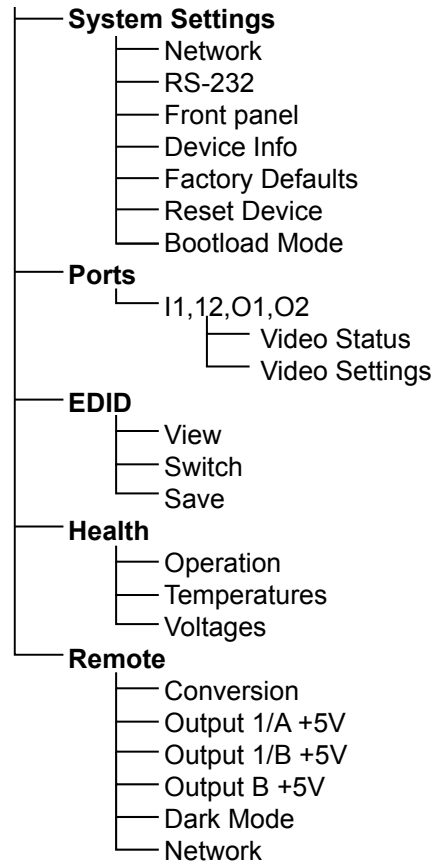
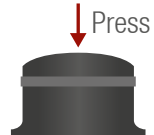

#### Parameter Selection

The **blue** colored line means the selected menu/parameter, the **green** one means the current setting.

**TIPS AND TRICKS:** The faster you rotate the jog dial, the faster the parameter list is scrolled.

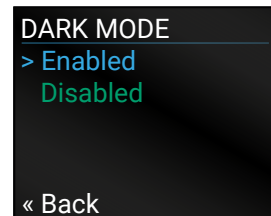

#### 4.3.1. System Settings Menu

##### Network Submenu

The parameters of the network connection can be set in this submenu. IP, Subnet, Gateway and MAC parameters show the current settings. If the DHCP option is disabled, three more parameters are listed which can be set for a static IP address:

- Static IP,
- Static Subnet,
- Static Gateway.

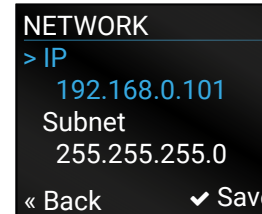

**ATTENTION!** If you change the network settings, always press the Save option under Network menu (not only in the submenu of the parameter) to apply the new settings.

##### RS-232 Submenu

Adjustable parameters of the local RS-232 port:

- Mode (Pass-through/ Control/ Command injection),
- Baud Rate (4800/ 7200/ 9600/ 14400/ 19200/ 38400/ 57600/ 115200)
- Protocol (LW2/ LW3).

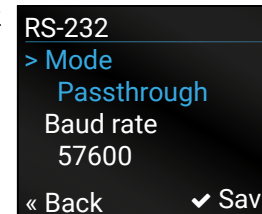

##### Front Panel Submenu

The following front panel-related parameters can be set in this submenu:

- Display Backlight (1-10)
- Dark Mode (Enabled/ Disabled)

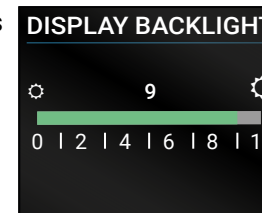

The brightness of the LCD can be set from 1 to 10 on a scale.

All the LEDs and the background light of the LCD on the transmitter unit are turned off 60 s after enabling the dark mode.

**TIPS AND TRICKS:** Press any buttons or turn the jog dial knob to "wake up" the device. The first contact activates the LEDs and LCD and does not execute the original function.

**INFO:** The setting of the dark mode in the receiver is available in the Remote Menu.

- Rotary Direction (CW Down/ CCW Down)

##### Device Info Submenu

In this submenu you can check basic information about the transmitter unit:

- Serial number
- Hardware Version
- Firmware Version
- Video MCU #1
- Video MCU #2

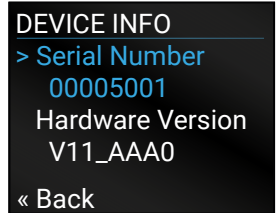

##### Factory Defaults Submenu

Factory default settings will be restored by choosing Yes.

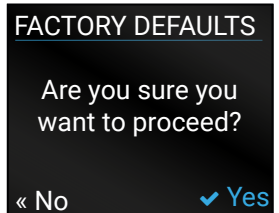

##### Reset Device Submenu

There is a possibility to reset the device.

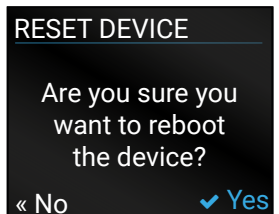

##### Bootload Mode Submenu

Special function for entering the bootload mode.

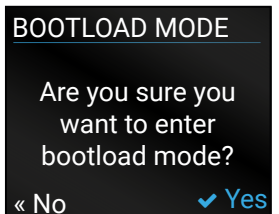

### 4.3.2. Ports Menu

When entering the menu the available video input and output ports are listed. The icons display information about the port and the video signal (see below table). Select the desired port and enter to see the submenu.

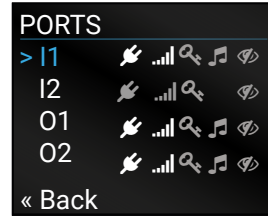

Grey icon	Description	White icon	Description
	Source/sink is <b>not</b> connected		Source/sink is connected
	No audio signal in the video stream		Audio is embedded in the video stream
	Signal is <b>not</b> present		Signal is present
	Signal is <b>not</b> encrypted with HDCP		Signal is encrypted with HDCP
	The port is unmuted		The port is muted

### Video Status Submenu for Input Ports

The most important status information can be seen of the chosen input port.

The table below relates to the input ports of both the transmitter and receiver.

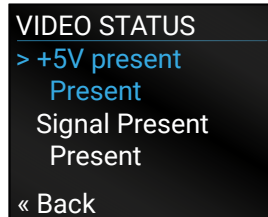

Parameter	I1	I2
+5V present	Present/ Not present	Present/ Not present
Signal Present	Present/ Not present/ Unknown	Present/ Not present/ Unknown
HDCP Status	none/ HDCP 1.4/HDCP 2.2	none/ HDCP 1.4
Embedded Audio	Present/ Not present/ Unknown	Present/ Not present/ Unknown
Pixel Clock (MHz)	No signal/ [x] MHz	No signal/ [x] MHz
Active Resolution	Unknown/ No signal/ [x]x[y][i\p][f]	-
Total Resolution	Unknown/ No signal/ [x]x[y]	-

### Video Settings Submenu for Input Ports

- I1: HDCP Enable (Disabled / HDCP 1.4 only / HDCP 2.2 or 1.4)
- I2: HDCP Enable (Disabled / HDCP 1.4 only)

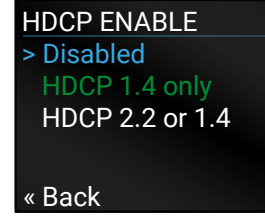

### Video Status Submenu for Output Ports

The most important status information can be seen of the chosen output port.

The table below relates to the output ports of both the transmitter and receiver.

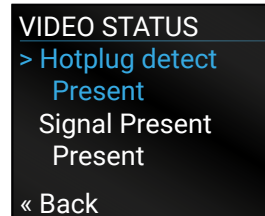

Parameter	O1 (OPTOUT)	O2 (HDMIOUT)
Hotplug detect	Present/ Not present	Present/ Not present
Signal Present	Present/ Not present/ Unknown	Present/ Not present/ Unknown
HDCP Status	none/ HDCP 1.4/HDCP 2.2	none/ HDCP 1.4/ HDCP 2.2
HDCP capability	-	none/ HDCP 1.4/ HDCP 2.2
Embedded Audio	Present/ Not present/ Unknown	Present/ Not present/ Unknown
Pixel Clock (MHz)	No signal [x] MHz	No signal [x] MHz
Active Resolution	Unknown/ No signal [x]x[y][i\p][f]	Unknown/ No signal [x]x[y][i\p][f]
Total Resolution	Unknown/ No signal/ [x]x[y]	Unknown/ No signal/ [x]x[y]

### Video Settings Submenu for Output Ports

- Signal Type (Auto / DVI)
- +5V Enable (Always on / Always off / Auto)
- HDCP Mode (Auto / Always on)

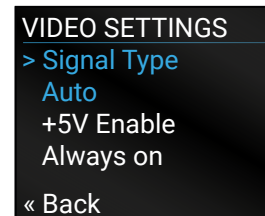

### 4.3.3. EDID Menu

Advanced EDID Management is available in the front panel LCD menu which allows to view an EDID, switch, or save it to the User EDID memory. See more information about EDID technology in [EDID Management](#). The EDID memory structure of the device can be found in [Sources and Destinations](#) chapter.

#### View Submenu

Select the desired EDID memory block: **Factory EDIDs**, **Last Attached EDIDs**, **User EDIDs**, or **Emulated EDIDs**. Select the **Name** item and press the knob. Use the jog dial to step between the EDIDs. The following information can be checked:

- Preferred Resolution
- Monitor Name
- Audio Info

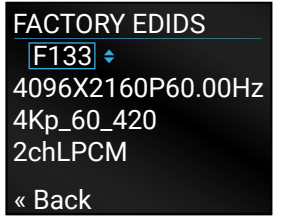

#### Switch Submenu

The submenu looks similar to the View submenu but in this case, the Destination is also listed. To change an EDID do the followings:

- Step 1. Navigate to the **EDID/Switch** submenu.
- Step 2. Select the **Name** item and press the knob. Use the jog dial to select the desired **EDID** (F1-F146, U1-U14, or D1-D2) and press the knob.
- Step 3. Select the **Destination** item and press the knob. Use the jog dial to select the desired **EDID memory** (E1, E2, All) and press the knob.
- Step 4. Navigate to the **Switch** option and press the knob.

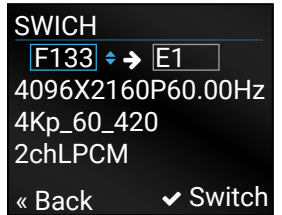

#### Save Submenu

The EDID of a connected sink can be saved to the User EDID memory as follows:

- Step 1. Navigate to the EDID/Save submenu.
- Step 2. Select the **Name** item and press the knob. Use the jog dial to select the desired **EDID** (D1-D2\*) and press the knob.
- Step 3. Select the **Destination** item and press the knob. Use the jog dial to select the desired **EDID memory** (U1-U14) and press the knob.
- Step 4. Navigate to the **Save** option and press the knob.

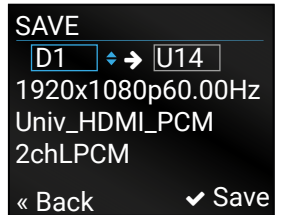

\* D1 is for Optical output and D2 is for local HDMI output.

#### 4.3.4. Health Menu

##### Operation Submenu

The following information is displayed about the transmitter unit in this menu:

- Uptime: the elapsed time since the last booting.
- Operation time: displays the summary of the operation hours.

```
OPERATION
> Uptime
  0 days 02:33:23
Operation Time
  5 days 06:12:44
« Back
```

##### Temperatures Submenu

This submenu gives a feedback about the current temperatures of the internal parts in the unit:

- CPU / System / Air intake / Video chip / Ethernet switch / Video MCU #1 / Video MCU #2.

##### Voltages Submenu

The following information is displayed in Voltages Submenu:

- Main 5V / Main 3.3V, Video IC #11.3V V/1 / Video IC #11.3V V/2 / Video IC #2 1.3V/1 / Video IC #2 1.3V/2

#### 4.3.5. Remote Menu



**ATTENTION!** This settings related to the connected **receiver**.

Adjustable parameters of the receiver:

##### Conversion Submenu

The following conversion modes can be set in the receiver:

- Off
- YUV 4:2:0
- Split left/right
- Split right/left

See more details about this mode in [Output Conversion Modes](#) section.

##### Output 1/A +5V, Output 1/B +5V, Output 2 +5V Submenu

- Always on
- Always off
- Auto

##### Dark Mode (Enabled/Disabled) Submenu

All the LEDs on the receiver unit are turned off 60 seconds after enabling the dark mode. Waking up the device is available by disabling the dark mode.

##### Network Submenu

The parameters of the **receiver's** network connection can be set in this submenu. IP, Subnet, Gateway and MAC parameters show the current settings. If the DHCP option is disabled, three more parameters are listed which can be set for a static IP address:

- Static IP,
- Static Subnet,
- Static Gateway.

```
NETWORK
> IP
  192.168.0.102
Subnet
  255.255.255.0
« Back      ✓ Save
```

**ATTENTION!** If you change the network settings, always press the Save option under Network menu (not only in the submenu of the parameter) to apply the new settings.

# 5

## Software Control – Using Lightware Device Controller

The extender can be controlled by a computer through the LAN, RS-232 and USB ports using Lightware Device Controller (LDC). The software can be installed on a Windows PC or Mac OS X. The application can be downloaded from [www.lightware.com](http://www.lightware.com). The Windows and the Mac versions have the same look and functionality.

- ▶ OVERVIEW
- ▶ THE TREE STRUCTURE
- ▶ LW3 COMMANDS
- ▶ FORMAL DEFINITIONS
- ▶ SYSTEM COMMANDS
- ▶ VIDEO PORT AND CROSSPOINT SETTINGS
- ▶ NETWORK CONFIGURATION
- ▶ RS-232 PORT CONFIGURATION
- ▶ SENDING MESSAGE VIA THE COMMUNICATION PORTS
- ▶ EDID MANAGEMENT
- ▶ LW3 COMMANDS - QUICK SUMMARY

### 5.1. Install and Upgrade

**INFO:** After the installation, the Windows and the Mac application has the same look and functionality.

#### Installation for Windows OS

Run the installer. If the User Account Control drops a pop-up message click **Yes**.

During the installation you will be prompted to select the type of the installation: **normal** and the **snapshot** install:

Normal install	Snapshot install
Available for Windows and Mac OS X	Available for Windows
The installer can update only this instance	Cannot be updated
Only one updateable instance can exist for all users	More than one different version can be installed for all users

#### Comparison of installation types

**ATTENTION!** Using the Normal install as the default choice is highly recommended.

#### Installation for Mac OS X

Mount the DMG file with double clicking on it and drag the LDC icon over the Applications icon to copy the program into the Applications folder. If you want to copy the LDC into another location just drag the icon over the desired folder.

**INFO:** The MAC installer is equal with the Normal install in case of Windows and results an updateable version with the same attributes.

#### Upgrading of LDC

**Step 1.** Run the application.

The **Device Discovery** window appears automatically and the program checks the available updates on Lightware's website and opens the update window if the LDC found updates.

The current and the update version number can be seen at the top of the window and they are shown in this window even with the snapshot install.

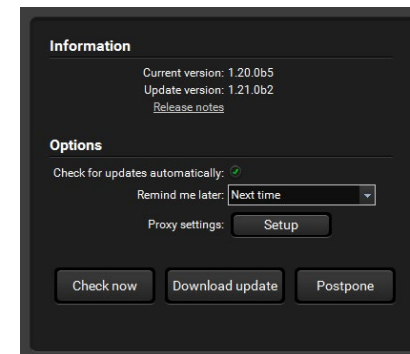

The **Update** window can also be opened by clicking the **About icon** and the **Update** button.

Set the desired update setting in the **Options** section.

- If you do not want to check for the updates automatically, uncheck the **circle**, which contains the green tick.
- If you want to postpone the update, a reminder can be set with different delays from the **drop down list**.
- If the proxy settings traverse the update process, set the proper values then click the **OK** button.

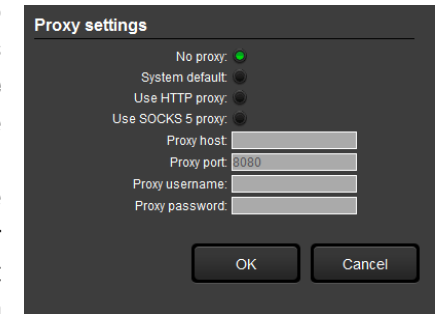

**Step 2.** Click the **Download update** button to start the upgrading.

The updates can be checked manually by clicking the **Check now** button.

### 5.2. Establishing the Connection

**Step 1.** Connect the device to a computer via USB, RS-232 or Ethernet.

**Step 2.** Run the controller software; device discovery window appears automatically.

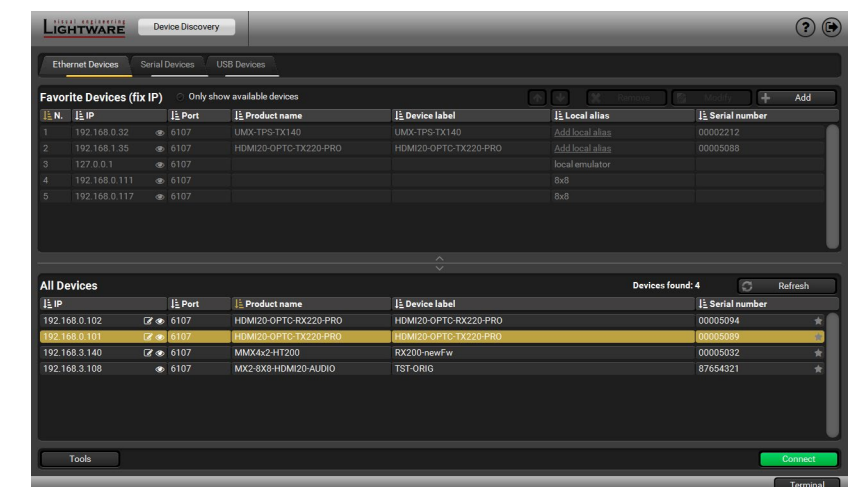

Device Discovery Window in LDC



**Step 3.** Select the unit from the discovered Ethernet devices or under USB devices; when the device is connected through RS-232 click on the **Query** button next to the desired serial port to display the device's name and serial number. Double click on the receiver or select the device and click on the **Connect** button.

**ATTENTION!** When the device is connected via the local RS-232 port, make sure that Control mode and LW3 protocol are set on the serial port.

**Change IP Address**



To modify IP address settings quickly it is not necessary to enter the device's settings/network menu, you can set them by clicking the pencil icon beside the IP address. In this window you can see only the new settings.

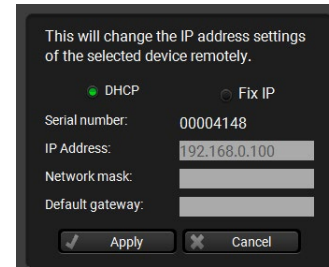

**Identifying the Device**



Clicking on the icon results the blinking of the LDC screen for 10 seconds. The feature helps to identify the device itself in the rack shelf.

**5.3. Crosspoint Menu - HDMI20-OPTC-TX220-Pro**

**Video tab**

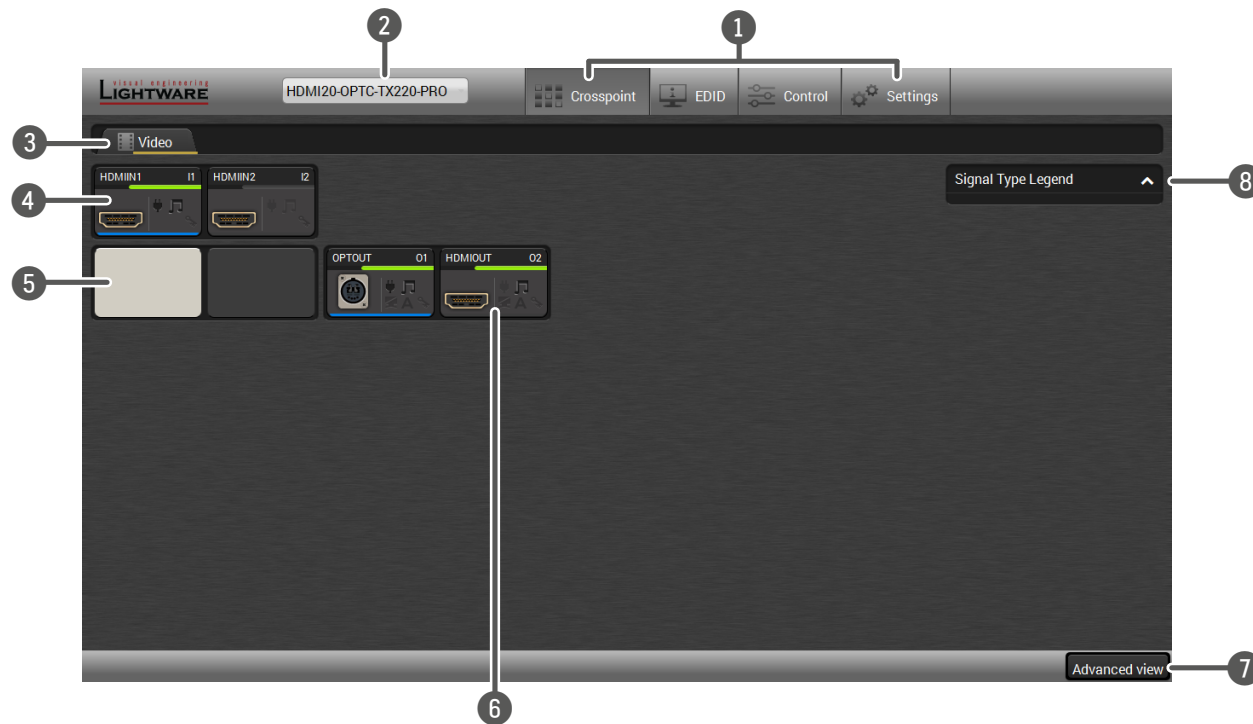

*Video Tab in Crosspoint Menu*

- 1 **Main menu** The available menu items are displayed. The active one is shown with dark grey background color.
- 2 **Information ribbon** It shows the device label which can be edited in the Settings menu - [Status Tab](#). A drop-down menu is displayed by clicking on this ribbon. You can turn back to the Device Discovery Window or open the connected TX or RX in a new window (if it is in the same LAN).
- 3 **Tab selector ribbon** Submenu selection by clicking on the tab.
- 4 **Input ports** Click on the port to open the Port properties window.
- 5 **Connections** Light grey square means the port is available but there is no connection between the input and the output. White square means there is a connection between the input and the output port.
- 6 **Output ports** Click on the port to open the Port properties window.
- 7 **Advanced view** Click on the button to display the Advanced view page. It shows the Terminal window and the LW3 protocol tree.
- 8 **Legend panel** The applied colors of the input/ output ports are described in this panel.

**Port Tiles**

The colors of the port tiles and the displayed icons represent different states and information:



- 1 Port name
- 2 Port icon
- 3 Port number
- 4 Signal present indicator  
**green:** present / **grey:** not present
- 5 State indicators

**State Indicators**

Icon	Icon is grey	Icon is black
	Source/sink is <b>not</b> connected	Source/sink is connected (+5V / Hotplug detected)
	Audio is <b>not</b> embedded in the video stream	Audio is embedded in the video stream
	Port is unmuted	Port is muted
	HDCP encryption is <b>not</b> enabled	HDCP encryption is enabled
Icon	Icon is grey	Icon is green
	Autoselect setting is disabled	Autoselect setting is enabled

## 5.4. Port Properties Window

### 5.4.1. HDMI Input Port - Transmitter

By clicking on one of the HDMI input tile, the most important video related information and settings are available in the port properties window.

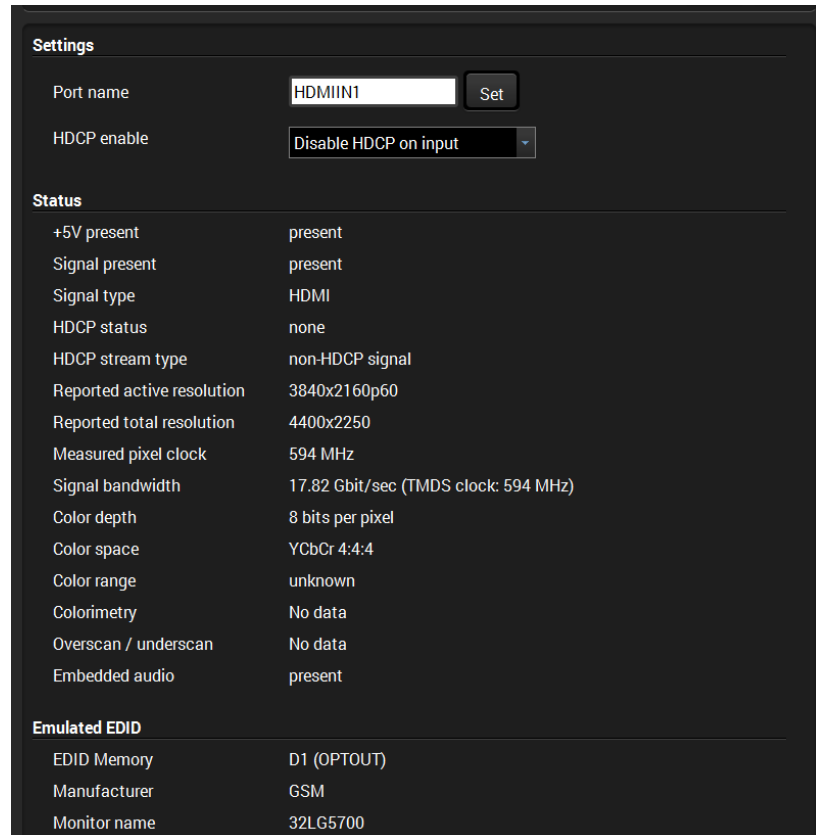

#### Available Settings:

- Port name
- HDCP Enable (Disable HDCP input / Allow HDCP 1.4 only / Allow HDCP 2.2 and HDCP 1.4).

Port number	max. HDCP version
I1	HDCP 2.2
I2	HDCP 1.4

- Reloading factory defaults (see more details in [Factory Default Settings](#) section).

**INFO:** Factory default settings have not effect on the emulated EDID.

### 5.4.2. HDMI Output Port - Transmitter

Click on the local HDMI output port to open the port properties window. The most important information and settings are available from the panel.

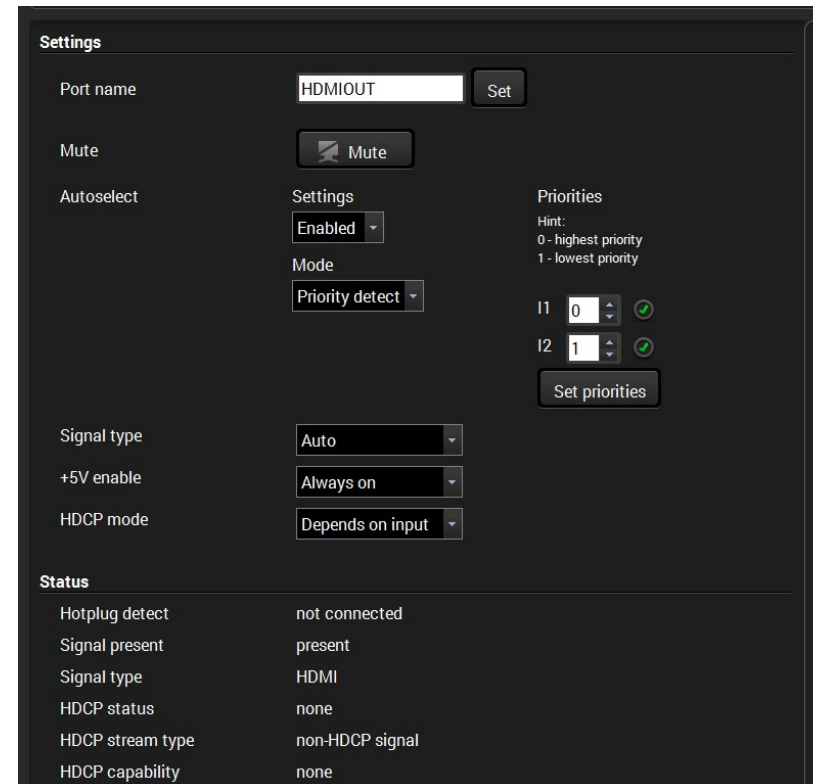

#### Available settings:

- Change the name of the port;
- Mute/unmute the port;
- Autoselect settings: enable / disable, mode, and priorities. (See more details in [Autoselect Feature](#) section)
- Auto/DVI/HDMI signal type;
- Enabling the +5V: Auto / Always on / Always off;
- HDCP mode: Depends on input / Maximum possible

**Depends on input:** The encryption level depends on the settings of the input port and the source content/device. If the incoming signal is not encrypted, then the outgoing signal will not be encrypted either.

**Maximum possible:** The highest supported level of encryption.

- Factory default settings for the selected port.

### Optical Output Port - Transmitter

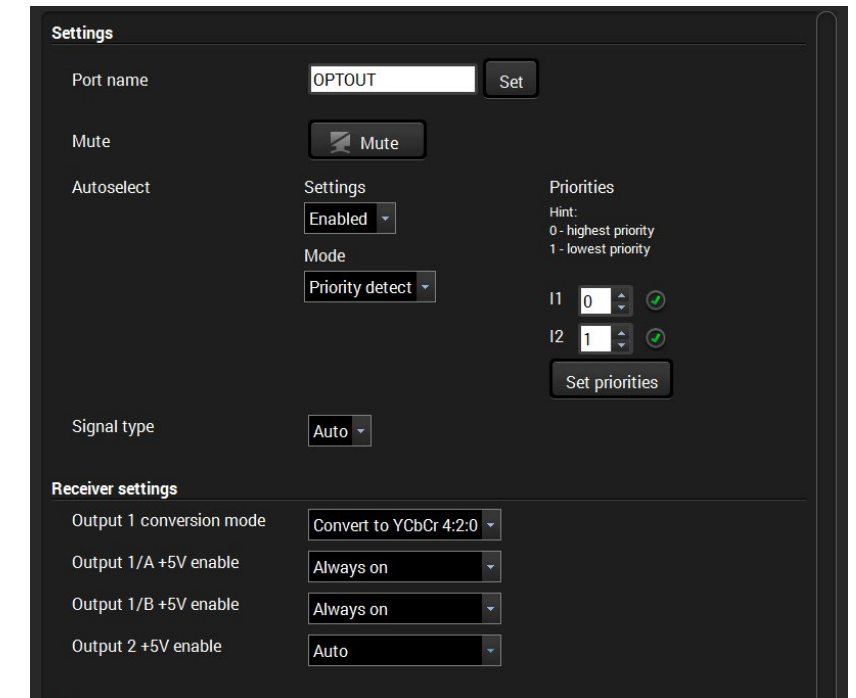

#### Available settings (related to the transmitter):

- Change the name of the port;
- Mute/unmute the port;
- Autoselect settings: enable / disable, mode, and priorities. This setting is always the same on both outputs. (See more details in [Autoselect Feature](#) section)
- Auto/DVI/HDMI signal type;
- Factory default settings for the selected port.

#### Available settings (related to the receiver):

- Output 1 conversion mode: No conversion / Convert to YCbCr 4:2:0 / Split A: left, B: right / Split A: right, B: left. For more information see [Output Conversion Modes](#) section.
- Output 1/A +5V enable: Auto / Always on / Always off
- Output 1/B +5V enable: Auto / Always on / Always off
- Output 2 +5V enable: Auto / Always on / Always off

### 5.4.3. Optical Input Port - Receiver

#### Available Settings:

- Port name;
- Reloading factory defaults (see factory default settings in the [Factory Default Settings](#) section).

INFO: Factory default settings have not effect on the emulated EDID.

### 5.4.4. HDMI Output Port - Receiver

#### Available Settings:

- Change the name of the port;
- Mute/unmute the port;
- Auto/DVI/HDMI signal type;
- Enabling the +5V: Auto / Always on / Always off
- HDCP mode: Depends on input / Maximum possible

**Depends on input:** The encryption level depends on the settings of the input port and the source content/device. If the incoming signal is not encrypted, then the outgoing signal will not be encrypted either.

**Maximum possible:** The highest supported level of encryption.

- Output 1 conversion mode: No conversion / Convert to YCbCr 4:2:0 / Split A: left, B: right / Split A: right, B: left. For more information see [Output Conversion Modes](#) section.

INFO: Conversion mode setting effects only on HDMIOUT1A (O1) and HDMIOUT1B (O2) port, so HDMIOUT2 (O3) port does not have not this setting.

- Factory default settings for the selected port.

## 5.5. EDID Menu

Advanced EDID Management can be accessed by selecting the EDID menu. There are two panels: left one contains **Source EDIDs**, right one contains **Destination** slots where the EDIDs can be emulated or copied.

Mem...	Manu...	Resolution	Audio	Monitor Name	Memory	Man...	Resolution	Audio	Monitor Name	So...
F131	LWR	4096x2160p25.00Hz	2chLPCM	H4096x2160p25	E1 (HDMIIN1)	GSM	1920x1080p59.93Hz	2chLPCM	32LG5700	D1
F132	LWR	4096x2160p30.00Hz	2chLPCM	H4096x2160p30	E2 (HDMIIN2)	GSM	1920x1080p59.93Hz	2chLPCM	32LG5700	D1
F133	LWR	4096x2160p60.00Hz	2chLPCM	4Kp60_420						
F134	LWR	3440x1440p23.99Hz	2chLPCM	H3440x1440p24						
F135	LWR	4096x2160p24.00Hz	2chLPCM	H4096x2160p24						
F136	LWR	3840x2400p29.99Hz	2chLPCM	H3840x2400p30						
F137	LWR	3840x2160p60.00Hz	2chLPCM	HUHDp60_444						
F138	LWR	3840x2160p50.00Hz	2chLPCM	HUHDp50_444						
F139	LWR	3840x2160p60.00Hz	2chLPCM	H2_UHD_PCM						
F140	LWR	3840x2160p60.00Hz	2chLPCM,8ch...	H2_UHD_ALL						
F141	LWR	4096x2160p60.00Hz	2chLPCM	H4Kp60_444						
F142	LWR	4096x2160p50.00Hz	2chLPCM	H4Kp50_444						
F143	LWR	4096x2160p60.00Hz	2chLPCM	H2_4K_PCM						
F144	LWR	4096x2160p60.00Hz	2chLPCM,8ch...	H2_4K_ALL						
F146	LWR	3840x2160p60.00Hz	2chLPCM	H2_UHD_HDR						
F147	LWR	3840x2160p60.00Hz	2chLPCM	H2_UHD_RB_PCM						
F148	LWR	3840x2160p60.00Hz	2chLPCM,8ch...	H2_UHD_RB_ALL						

### Control buttons

	Export	Exporting an EDID (save to a file)		Executing EDID emulation or copying (Transfer button)
	Import	Importing an EDID (load from a file)		Deleting EDID (from User memory)
	Info	Display EDID Summary window		Selecting all memory places in the right panel
	Edit	Opening Advanced EDID Editor with the selected EDID		Selecting none of the memory places in the right panel
	Create	Opening Easy EDID Creator		

### 5.5.1. Sources and Destinations

The EDID memory consists of four parts:

- **Factory EDID list (F1-F146)** the pre-programmed EDIDs, see the [Factory EDID List](#) in the Appendix section.
- **Dynamic EDID list (D1-D2)**: the EDID of the last attached display device. The extender stores the last EDID from the previously connected sink on each output port. Thus, an EDID can be shown even if there is no device is connected to the output port at that moment.
- **User memory locations (U1 – U14)**: they can be used to save custom EDIDs. Any EDID from the User/Factory/Dynamic EDID lists can be copied to the user memory.
- **Emulated EDID list (E1-E2)**: the currently emulated EDID for the input. The source column displays the memory location that the current EDID was routed from. The source reads the EDID from the Emulated EDID memory on the input port.

There are two types of emulation: **static** and **dynamic**.

- **Static EDID emulation**: an EDID from the Factory or User EDID list is selected. Thus, the Emulated EDID remains the same until the user emulates another EDID.
- **Dynamic EDID emulation**: it can be enabled by selecting D1-D2 EDID memory. The attached monitor's EDID is copied to the input; if a new monitor is attached to the output, the emulated EDID is changed automatically.

**INFO:** The default emulated EDID is D1 both the transmitter and the receiver. The EDID, which is from the attached monitor of HDMIOUT1A (O1) port of the receiver, is copied to all the input ports.

### 5.5.2. EDID Operations

#### Changing the Emulated EDID

- Step 1.** Choose the desired tab (**Factory**, **Dynamic**, or **User** EDID list) on the left panel and select an **EDID**.
- Step 2.** Select the **Emulated** tab on the right panel.
- Step 3.** Select the **target port** on the right panel (one or more ports can be selected); the EDID(s) will be highlighted with a yellow cursor.
- Step 4.** Press the **Transfer** button to change the emulated EDID.

#### Learning an EDID

The process is the same as changing the emulated EDID; the only difference is the **Destination** panel: press the **User** button. Thus, one or more EDIDs can be copied into the user memory either from the factory memory or from a connected sink (Dynamic).

#### Exporting an EDID

Source EDID can be downloaded as a file (\*.bin, \*.dat or \*.edid) to the computer.

- Step 1.** Select the desired **EDID** from the **left panel** (the line will be highlighted with yellow).
- Step 2.** Press the **Export** button to open the dialog box and **save** the file to the computer.



### Importing an EDID

Previously saved EDID (\*.bin, \*.dat or \*.edid file) can be uploaded to the **user memory**:

**Step 1.** Select the **User** tab in the left panel and select a memory slot.

**Step 2.** Press the **Import** button below the Source panel.

**Step 3.** Browse the file in the opening window then press the **Open** button. Browsed EDID is imported into the selected User memory.



**ATTENTION!** The imported EDID overwrites the selected memory place even if it is not empty.

### Deleting EDID(s)

The EDID(s) from User memory can be deleted as follows:

**Step 1.** Select the **User** tab in the left panel.

**Step 2.** Select the desired memory slot(s); one or more can be selected (**Select all** and **Select None** buttons can be used). The EDID(s) will be highlighted with yellow.

**Step 3.** Press the **Deleted selected** button to delete the EDID(s).



### 5.5.3. EDID Summary Window

Select an EDID from Source panel and press the **Info** button to display EDID summary.

General	General
General	EDID version: 1
Power Management	EDID revision: 3
Gamma / Colors	Manufacturer ID: GSM (Goldstar Company Ltd)
Established Timings	Product ID: 085B
Standard Timings	Monitor serial number: 356928
Preferred Timing Mode	Year of manufacture: 2017
2nd Descriptor Field	Week of manufacture: 3
3rd Descriptor Field	Signal interface: Digital
4th Descriptor Field	Separate Sync H&V: -
CEA General	Composite sync on H: -
CEA Video	Sync on green: -
CEA Audio	Serration on VS: -
CEA Speaker Allocation	Color depth: Undefined
CEA HDMI VSDB	Interface standard: Not defined
CEA HDMI Forum VSDB	Color spaces: RGB 4:4:4 & YCrCb 4:4:4
CEA YCbCr 4:2:0 VDB	Aspect ratio: 0.57
CEA YCbCr 4:2:0 Capability Map	Display size: 60 cm X 34 cm
CEA Colorimetry	
CEA High Dynamic Range	
CEA Detailed Timing Descriptors	

### 5.5.4. Editing an EDID

Select an EDID from the left panel and press the **Edit** button to display Advanced EDID Editor window. The editor can read and write all descriptors, which are defined in the standards, including the additional CEA extension. Any EDID from the device's memory or a saved EDID file can be loaded into the editor. The software resolves the raw EDID and displays it as readable information to the user. All descriptors can be edited, and saved in an EDID file, or uploaded to the User memory. For more details about EDID Editor please visit our website ([www.lightware.com](http://www.lightware.com)) and download the EDID Editor User's Manual.

Basic EDID	EDID Byte Editor
Vendor / Product Information	0 00 FF FF FF FF FF 00 1E 6D
Display Parameters	10 08 5B 40 72 05 00 03 1B 01 03
Power Management and Features	20 80 3C 22 78 EA 30 35 A7 55 4E
Gamma / Color and Established Timings	30 A3 26 0F 50 54 21 08 00 71 40
Standard Timings	40 81 80 81 C0 A9 C0 D1 C0 81 00
Preferred Timing Mode	50 01 01 01 01 04 74 00 30 F2 70
2nd Descriptor Field	60 5A 80 B0 58 8A 00 58 54 21 00
3rd Descriptor Field	70 00 1E 56 5E 00 A0 A0 A0 29 50
4th Descriptor Field	80 30 20 35 00 58 54 21 00 00 1A
CEA Extension	90 00 00 00 FD 00 38 3D 1E 87 1E
General	100 00 0A 20 20 20 20 20 20 00 00
Video Data	110 00 FC 00 4C 47 20 55 6C 74 72
Audio Data	120 61 20 48 44 0A 20 01 D2
Speaker Allocation Data	
HDMI VSDB	
HDMI Forum VSDB	
YCbCr 4:2:0 VDB	
YCbCr 4:2:0 Capability Map	
Colorimetry	
High Dynamic Range	
Detailed Timing Descriptor #1	
Detailed Timing Descriptor #2	
Detailed Timing Descriptor #3	
Detailed Timing Descriptor #4	
Detailed Timing Descriptor #5	
Detailed Timing Descriptor #6	
Save EDID	

EDID Editor Window

### 5.5.5. Creating an EDID

Since above mentioned Advanced EDID Editor needs more complex knowledge about EDID, Lightware introduced a wizard-like interface for fast and easy EDID creation. With Easy EDID Creator it is possible to create custom EDIDs in four simple steps. By clicking on the **Create** button below the left panel, Easy EDID Creator is opened in a new window.

**Select Resolution & Interface**

Welcome to the Easy EDID Creator!

With this software you are able to create a unique EDID according to your demands. Details can be added or changed in the Advanced EDID Editor later if needed.

Please select the format type and the preferred resolution. If you don't find the proper mode in the list, use the Custom format type setting, enter the resolution and the program will estimate the best blanking times.

Important notes:

- If you want to send audio then you must select HDMI or DisplayPort. DVI and VGA do not support audio transmission.
- Most DVI displays are not able to process HDMI signals. If you have a DVI display, please check its specifications.
- The supported color depth will be 24bits/pixel by default.

Format type:

Resolution:

Interface type:

*Easy EDID Creator Wizard*

## 5.6. Control Menu

### 5.6.1. RS-232 Tab

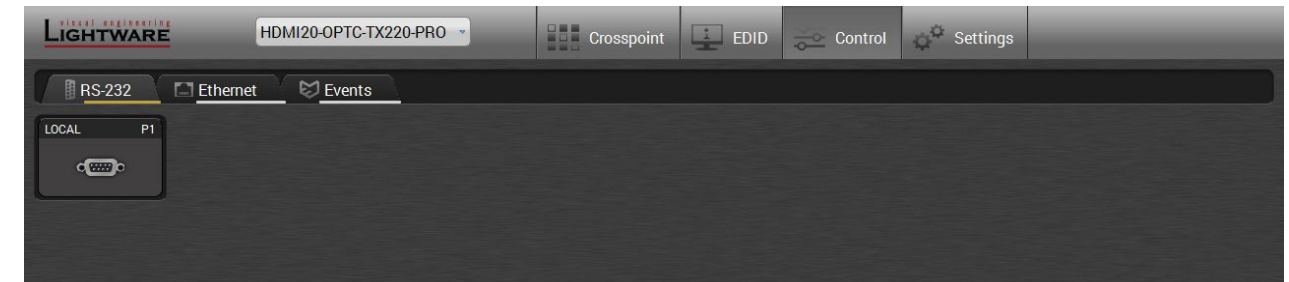

*RS-232 tab in Control menu*

The following settings and functions are available on the local RS-232 port:

- Port name
- Operation mode: Pass-through, Control, Command Injection, (for more details see [Serial Interface](#) section);
- Baud rate: 4800, 7200, 9600, 14400, 19200, 38400, 57600, 115200;
- Data bits: 8 or 9;
- Parity: None, Odd, or Even;
- Stop bits: 1, 1.5, or 2;
- Command injection: enable or disable;
- Command injection port number;
- Control protocol: LW2 or LW3;
- Message sending via serial port;
- Reloading factory defaults (see the [Factory Default Settings](#) section).

**Port 1 - LOCAL**

**Settings**

Port name:

Operation mode:

Baud rate:

Data bits:

Parity:

Stop bits:

Configuration: 57600, 8N1

**Command injection**

Enable command injection:

Port:

Status: Disabled

**Control protocol**

Required protocol:

Actual protocol: LW2

**Send message**

Send message:

**Other**

Factory defaults:

### 5.6.2. Ethernet Tab

Four ports are displayed in the Ethernet tab: Ethernet (P1, P2), OPT1, and CPU. The Ethernet ports (P1 and P2) display the status of the Ethernet, speed, and the duplexity of the connection. The following settings are also available:

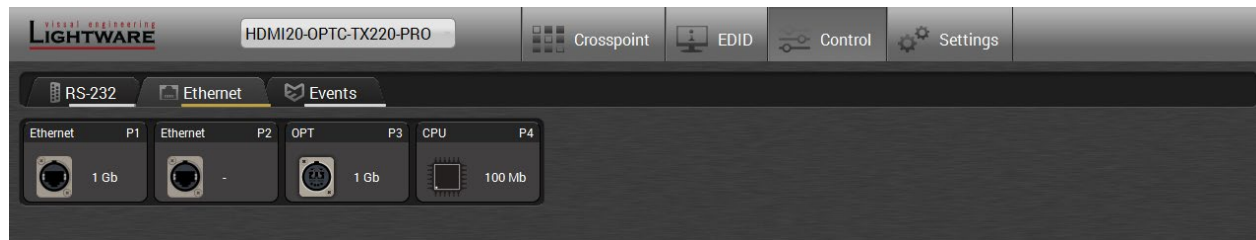

- Enable / disable the port (for loop protection);
- Reloading factory defaults (see factory default settings in the [Factory Default Settings](#) section).

**ATTENTION!** If the Ethernet port is set to disabled, this may break the connection with the device.

**INFO:** OPT1 and CPU Ethernet port can not be disabled.

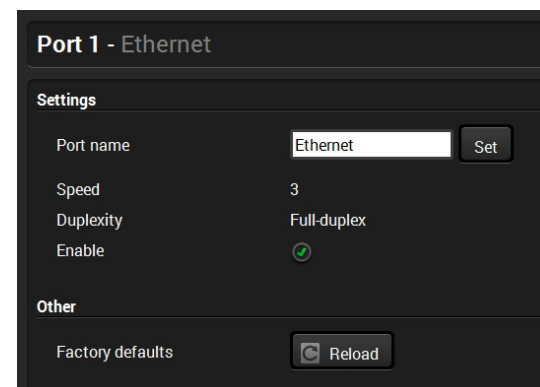

### 5.7. Event Manager

The feature means that the device can sense changes on its ports and able to react according to the pre-defined settings. The development idea of the Event manager is based on users' feedbacks. In many cases internal events (such as signal present) are necessary to display but it is not easy when the device is hard to access (e.g. built under the desk).



**INFO:** For tips and tricks and detailed description about the application of Event Manager, please download the Event Manager User's Guide from the Download section on the [www.lightware.com](http://www.lightware.com).

The Event manager can be configured to perform an action if a condition has been detected. E.g. the desired setup is that after a certain type of signal has been detected on I1 port, the port has to be switched to O1. The settings can be done via the LDC in the Control/Events tab, or by LW3 protocol commands. Configurable events number depends on the device what you are using actually.

Numerous new ideas and requests have been received in connection with the features and settings of the Event manager since the first release. Therefore, the user interface has been re-designed and many new functions implemented. The Event editor can be opened by pressing the Edit button at each Event.

There is a **gray bar** on the left of the Event panel in each line. If a condition and an action are set and the Event is enabled, the bar is displayed in **green**.

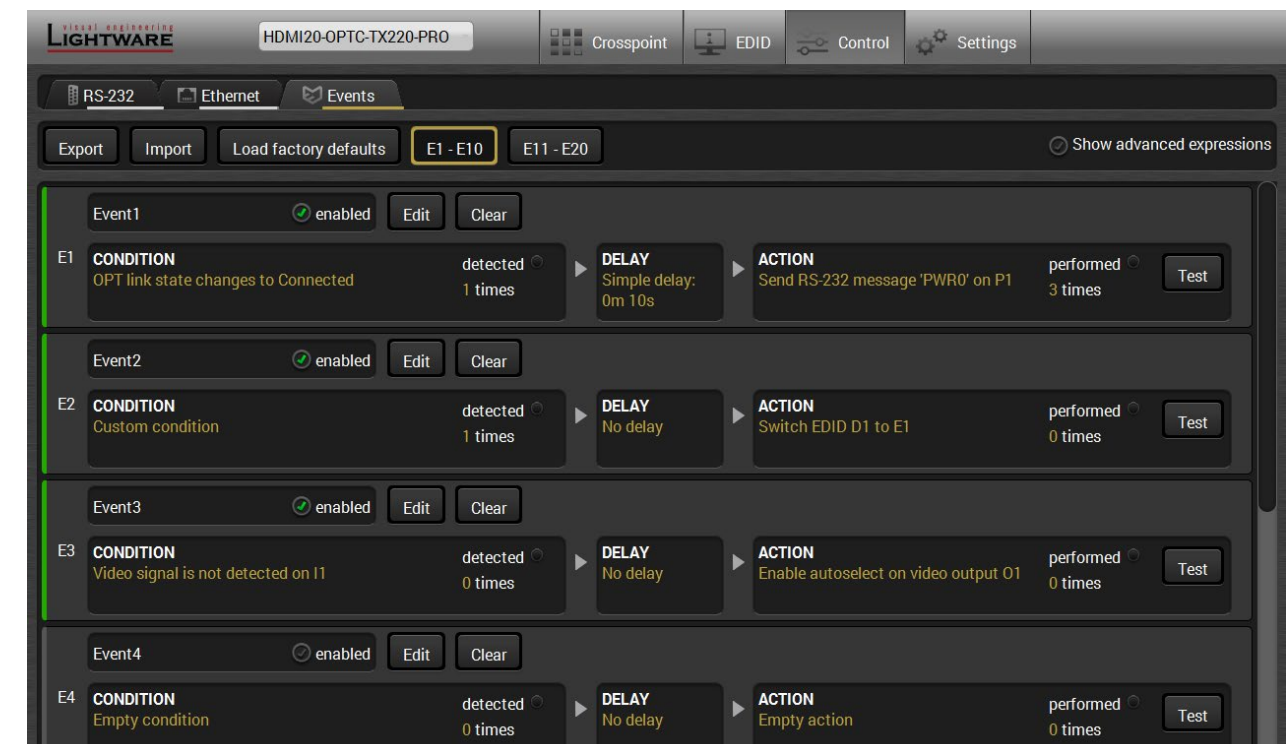

Control menu, Event Manager tab

### 5.7.1. The Event Editor

Press the **Edit** button in the desired Event line to open the Event editor window.

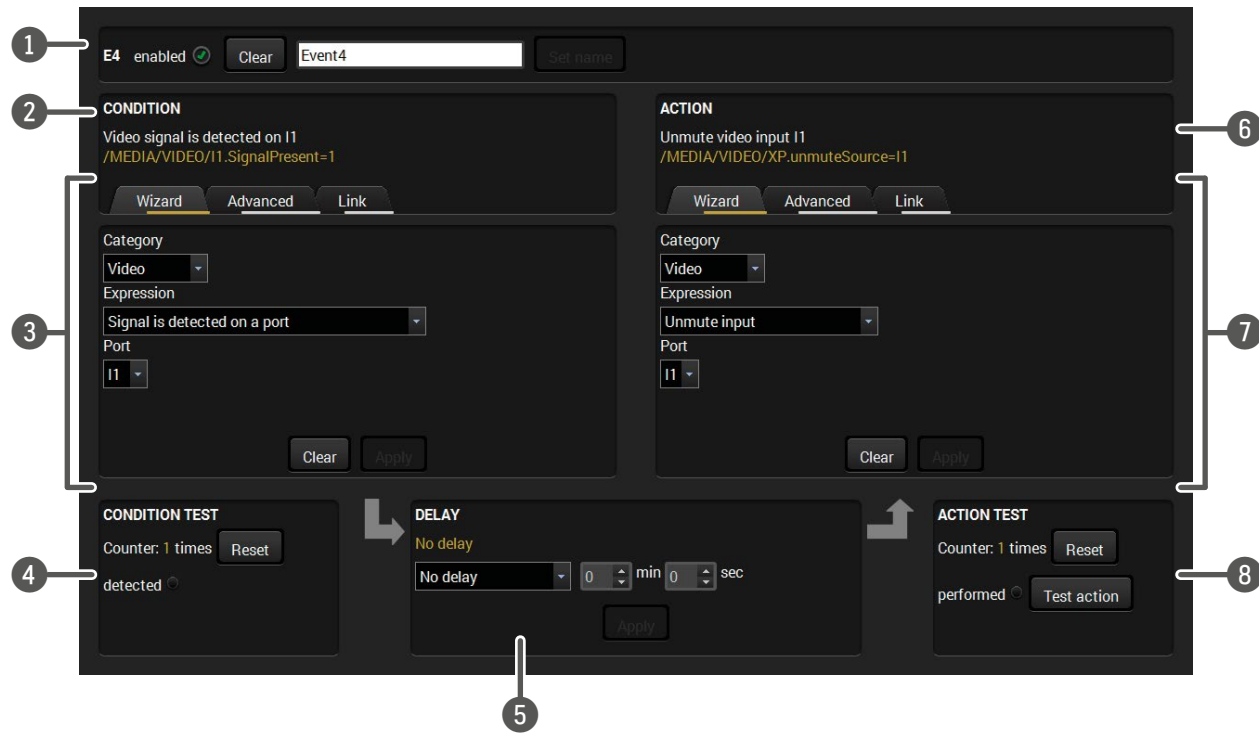

- 1 **Event header** The name of the Event is displayed. Type the desired name and press the Set name button. The Event can be cleared by the Clear button. Use the tick mark to enable/disable the Event.
- 2 **Condition header** If the condition is set, the description (white colored text) and the exact LW3 protocol expression (yellow colored text) can be seen. If the advanced mode was used the description is "Custom condition".
- 3 **Condition panel** The Wizard, the Advanced or the Link tool is available to set the condition. The parameters and settings are displayed below the buttons.
- 4 **Condition test** The set condition can be tested to see the working method in the practice.
- 5 **Delay settings** The action can be scheduled to follow the condition after the set time value.
- 6 **Action header** If the action is set, the description (white colored text) and the exact LW3 protocol expression (yellow colored text) can be seen. If the advanced mode was used the description is "Custom action".
- 7 **Action panel** The Wizard, the Advanced or the Link tool is available to set the action. The parameters and settings are displayed below the buttons.
- 8 **Action test** The set action can be tested to see the working method in the practice.

### 5.7.2. Create or Modify an Event

#### Wizard Mode

The wizard mode lists the most common conditions and actions, so the user does not have to look for LW3 nodes and properties.

- Step 1.** Click on the **Edit** button of the desired Event; the **Event editor** is displayed.
- Step 2.** The wizard mode is displayed as default. Select the desired **Category** first (e.g. Audio or Video).
- Step 3.** Select the desired **Expression** from the drop-down menu. If any other parameter is necessary to set, it is going to be displayed.
- Step 4.** Press the **Apply** button to store the settings of the Condition.

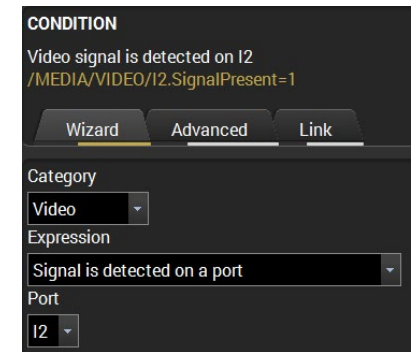

Conditions and actions in wizard mode in the transmitter			
<b>Condition</b>			
Category	Expression	Ports	
General	Select button is pressed		
	OPT link state changes to Connected		
	OPT link state changes to Disconnected		
Video	Signal is detected on a port	I1, I2, O1, O2	
	Signal is not detected on a port	I1, I2, O1, O2	
	Signal type changes to DVI	I1, I2, O1, O2	
	Signal type changes to HDMI	I1, I2, O1, O2	
	Signal type changes to Undefined (no signal)	I1, I2, O1, O2	
<b>Action</b>			
Category	Expression	Input	Output
Video	Switch input to output	I1, I2	O1, O2
	Enable autoselect on output		O1, O2
	Disable autoselect on output		O1, O2
	Mute input	I1, I2	
	Mute output		O1, O2
	Unmute input	I1, I2	
	Unmute output		O1, O2
		Port	Message
RS-232	Send RS-232 message	P1	
		Source EDID	Destination EDID
EDID	Switch EDID	F1-146	E1, E2
		D1-2	
		U1-14	



Conditions and actions in wizard mode in the receiver			
Condition			
Category	Expression	Ports	
General	Function button is pressed		
	OPT link state changes to Connected		
	OPT link state changes to Disconnected		
Video	Signal is detected on a port	I1, 01, 02, 03	
	Signal is not detected on a port	I1, 01, 02, 03	
	Signal type changes to DVI	I1, 01, 02, 03	
	Signal type changes to HDMI	I1, 01, 02, 03	
	Signal type changes to Undefined (no signal)	I1, 01, 02, 03	
Action			
Category	Expression	Input	Output
Video	Switch input to output	I1	01, 02, 03
	Enable autoselect on output		01, 02, 03
	Disable autoselect on output		01, 02, 03
	Mute input	I1	
	Mute output		01, 02, 03
	Unmute input	I1	
	Unmute output		01, 02, 03
RS-232	Send RS-232 message	P1	
		<b>Port</b>	<b>Message</b>
		<b>Source EDID</b>	<b>Destination EDID</b>
EDID	Switch EDID	F1-146	E1
		D1-2	
		U1-14	

### Advanced Mode

The goal of this mode is the same as of the wizard: set the properties and methods for conditions and actions. The difference is the number of the available and usable properties and methods of the LW3 protocol. Advanced mode allows almost all of it.

**Step 1.** Click on the **Edit** button of the desired Event; the **Event editor** is displayed.

**Step 2.** The wizard mode is the default, press the **Advanced** button. The LW3 protocol tree is displayed showing the list of the properties in the drop-down menu. Navigate to the desired node.

**Step 3.** Select the desired **Property** from the menu. The **manual** of the property is displayed below to help to select the necessary property and to set the value.

**Step 4.** Set the desired **value** and **operator**, then press the **Apply** button to store settings.

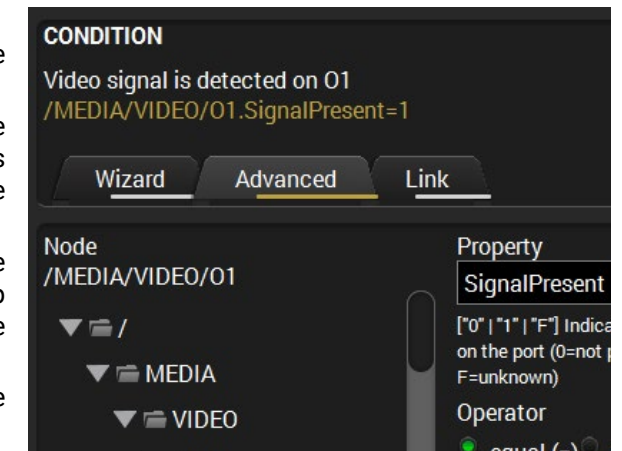

### The Link Tool

The interface allows creating more actions to the same condition. In that case, a condition can trigger more actions. To set such an Event, the Link tool has been introduced.

**Step 1.** Click on the **Edit** button of the desired Event; the **Event editor** is displayed.

**Step 2.** The wizard mode is displayed as default, press the **Link** button.

**Step 3.** All the saved Events are analyzed and the **conditions** are listed (it takes some seconds to finish). The **Show advanced expressions** option allows showing the exact path and set the value of the given property.

**Step 4.** Select the desired **Condition** and press the **Apply** button to store the settings.

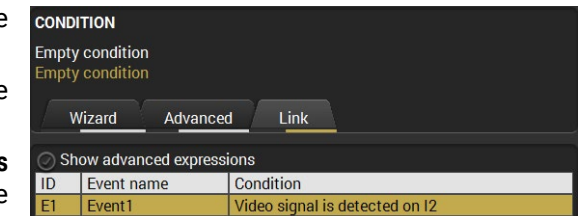

### 5.7.3. Special Tools and Accessories

#### The Name of the Event

The name of a port can be changed by typing the new name and clicking the **Set name** button. The following characters are allowed when naming:

Letters (A-Z) and (a-z), numbers (0-9), special characters: hyphen (-), underscore (\_), and space ( ).

#### Enable or Disable an Event

The set Event can be enabled or disabled in the Event list, or directly in the Event editor window by setting the **tick mark** beside the name.

#### Testing the Condition

When the desired Condition is arranged, the setting can be tested. The Event list and the Event editor contains a small panel that shows if the set condition is detected and how many times. The **Counter** can be reset by the button in Event editor. If the Condition is true, the **detected** mark turns green for two seconds and the **Counter** is increased.

#### Testing the Action

The method is the same as testing the Condition, but in this case, the Action can be triggered manually by pressing the **Test** button.

**TIPS AND TRICKS:** The Test button is also placed on the Action panel in the Event list. Thus, you can check the Actions without opening the Event editor.

#### Delay the Action

In most cases the Action is performed immediately after the Condition is detected. But sometimes a delay is necessary between the Condition and the Action. Therefore, the new Event manager contains the Delay panel which allows that feature with below settings:

- **No delay:** when the Condition is detected, the Action is launched.
- **Simple delay:** when the Condition is detected, the Action is launched after the set time interval.
- **Still exists:** when the Condition is detected, the Action is launched after the set time interval only if the Condition still exists.
- **Continuously exists:** when the Condition is detected, the Action is launched after the set time interval only if the Condition has been existing continuously.

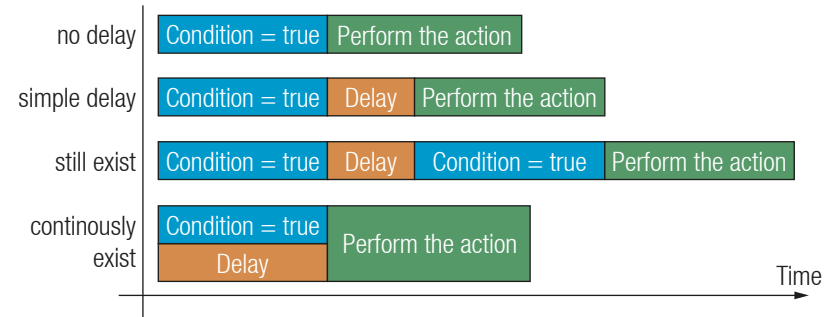

**The Available Delay Settings of an Event**

**TIPS AND TRICKS:** **Show advanced expressions** option is a useful tool when you look for the path or value of a property but just the expression is displayed. The option is available in the Event list window or when Link tool is used.

### 5.7.4. Clear One or More Event(s)

#### Clear an Event

Press the **Clear** button in the Event list or in the header section in the Event editor.

#### Clear all Events

When all the Events must be cleared press the **Load factory defaults** button above the Event list. You will be prompted to confirm the process.

### 5.7.5. Export and Import Events

The feature allows saving all the Events. The backup file can be uploaded to the same device type.

#### Export all the Events

**Step 1.** Press the **Export** button above the Event list.

**Step 2.** The Save as dialog box will appear. Set the desired folder and file name, then press the **Save** button.

The generated file is a simple text file which contains LW3 protocol commands. The file can be viewed by a simple text editor, e.g. Notepad.

**ATTENTION!** Editing the file is recommended only for expert users.

#### Import all the Events

**Step 1.** Press the **Import** button above the Event list.

**Step 2.** The Open dialog box will appear. Select the desired folder and file, then press the **Open** button.

## 5.8. Settings Menu

### 5.8.1. Status Tab

The most important hardware and software related information can be found on this tab: hardware and firmware version, serial numbers, temperatures, operation time, voltage information, and fan status. Device label can be changed to unique description by the **Set** button.

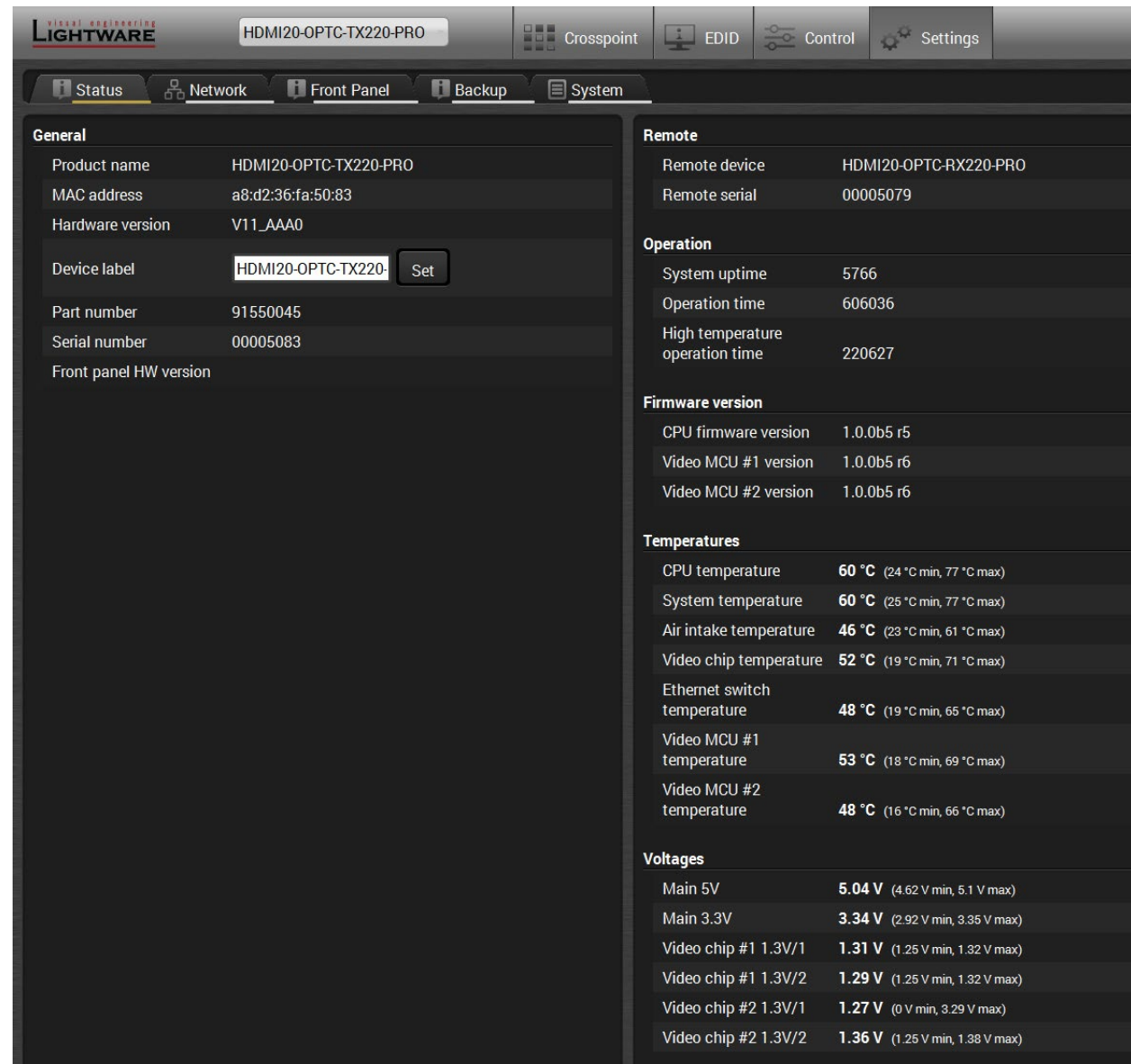

General	
Product name	HDMI20-OPTC-TX220-PRO
MAC address	a8:d2:36:fa:50:83
Hardware version	V11_AAA0
Device label	HDMI20-OPTC-TX220- <input type="button" value="Set"/>
Part number	91550045
Serial number	00005083
Front panel HW version	

Remote	
Remote device	HDMI20-OPTC-RX220-PRO
Remote serial	00005079

Operation	
System uptime	5766
Operation time	606036
High temperature operation time	220627

Firmware version	
CPU firmware version	1.0.0b5 r5
Video MCU #1 version	1.0.0b5 r6
Video MCU #2 version	1.0.0b5 r6

Temperatures	
CPU temperature	60 °C (24 °C min, 77 °C max)
System temperature	60 °C (25 °C min, 77 °C max)
Air intake temperature	46 °C (23 °C min, 61 °C max)
Video chip temperature	52 °C (19 °C min, 71 °C max)
Ethernet switch temperature	48 °C (19 °C min, 65 °C max)
Video MCU #1 temperature	53 °C (18 °C min, 69 °C max)
Video MCU #2 temperature	48 °C (16 °C min, 66 °C max)

Voltages	
Main 5V	5.04 V (4.62 V min, 5.1 V max)
Main 3.3V	3.34 V (2.92 V min, 3.35 V max)
Video chip #1 1.3V/1	1.31 V (1.25 V min, 1.32 V max)
Video chip #1 1.3V/2	1.29 V (1.25 V min, 1.32 V max)
Video chip #2 1.3V/1	1.27 V (0 V min, 3.29 V max)
Video chip #2 1.3V/2	1.36 V (1.25 V min, 1.38 V max)

### 5.8.2. Network Tab

IP address and DHCP settings can be set on this tab. Always press the **Apply changes** button to save changes. Factory default settings can be recalled with a dedicated button.

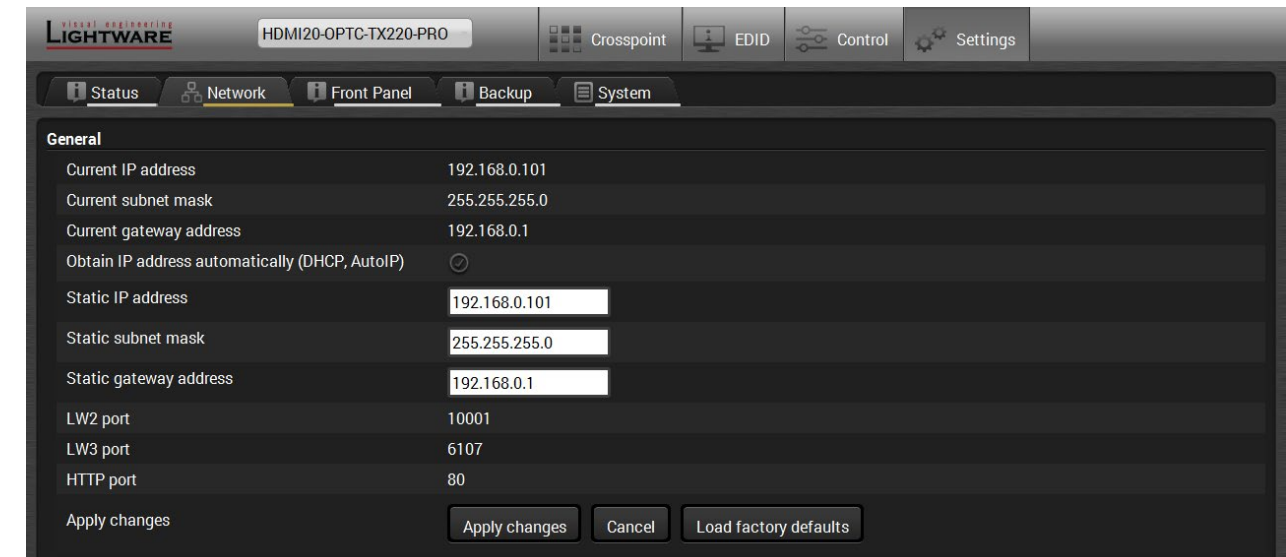

General	
Current IP address	192.168.0.101
Current subnet mask	255.255.255.0
Current gateway address	192.168.0.1
Obtain IP address automatically (DHCP, AutoIP)	<input type="radio"/>
Static IP address	<input type="text" value="192.168.0.101"/>
Static subnet mask	<input type="text" value="255.255.255.0"/>
Static gateway address	<input type="text" value="192.168.0.1"/>
LW2 port	10001
LW3 port	6107
HTTP port	80
Apply changes	<input type="button" value="Apply changes"/> <input type="button" value="Cancel"/> <input type="button" value="Load factory defaults"/>

### 5.8.3. Front Panel Tab

Certain settings in connection with the front panel LCD are available in the LDC as well.

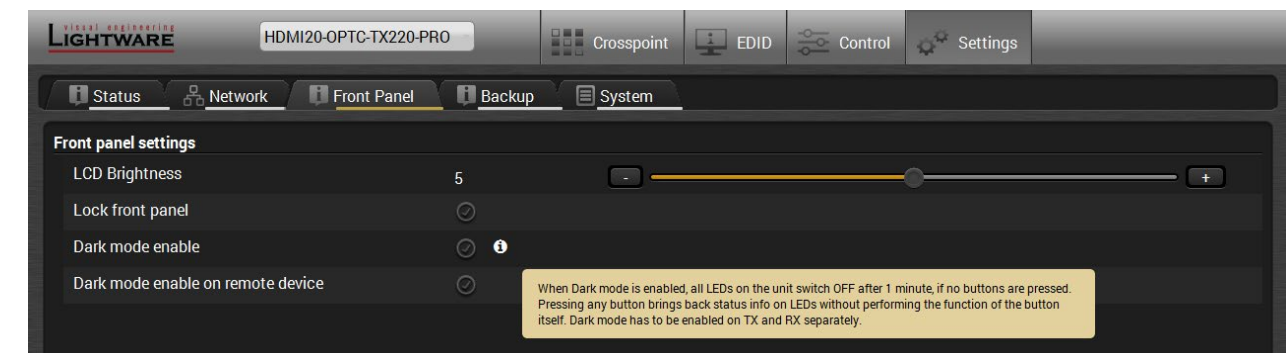

Front panel settings	
LCD Brightness	5 <input type="range"/>
Lock front panel	<input checked="" type="checkbox"/>
Dark mode enable	<input checked="" type="checkbox"/>
Dark mode enable on remote device	<input checked="" type="checkbox"/>

When Dark mode is enabled, all LEDs on the unit switch OFF after 1 minute, if no buttons are pressed. Pressing any button brings back status info on LEDs without performing the function of the button itself. Dark mode has to be enabled on TX and RX separately.

- **LCD brightness:** the slider can be set from 0 to 10. When the value is 0, the LCD is totally dark.
- **Lock front panel:** disables the control functions (button and jog dial knob) on the front panel.
- **Enable dark mode:** enable/disable lighting of the LEDs on the front panel of transmitter. See more about the dark mode in [Front Panel Submenu](#) section. The LEDs switch off after 60 s delay.
- **Enable dark mode on a remote device\*:** turn on/off the lighting of the LEDs on the front panel of the receiver (which connected directly to the transmitter via fiber).

\*Remote setting of the dark mode is available only in the transmitter.

### 5.8.4. Backup Tab (Configuration Cloning)

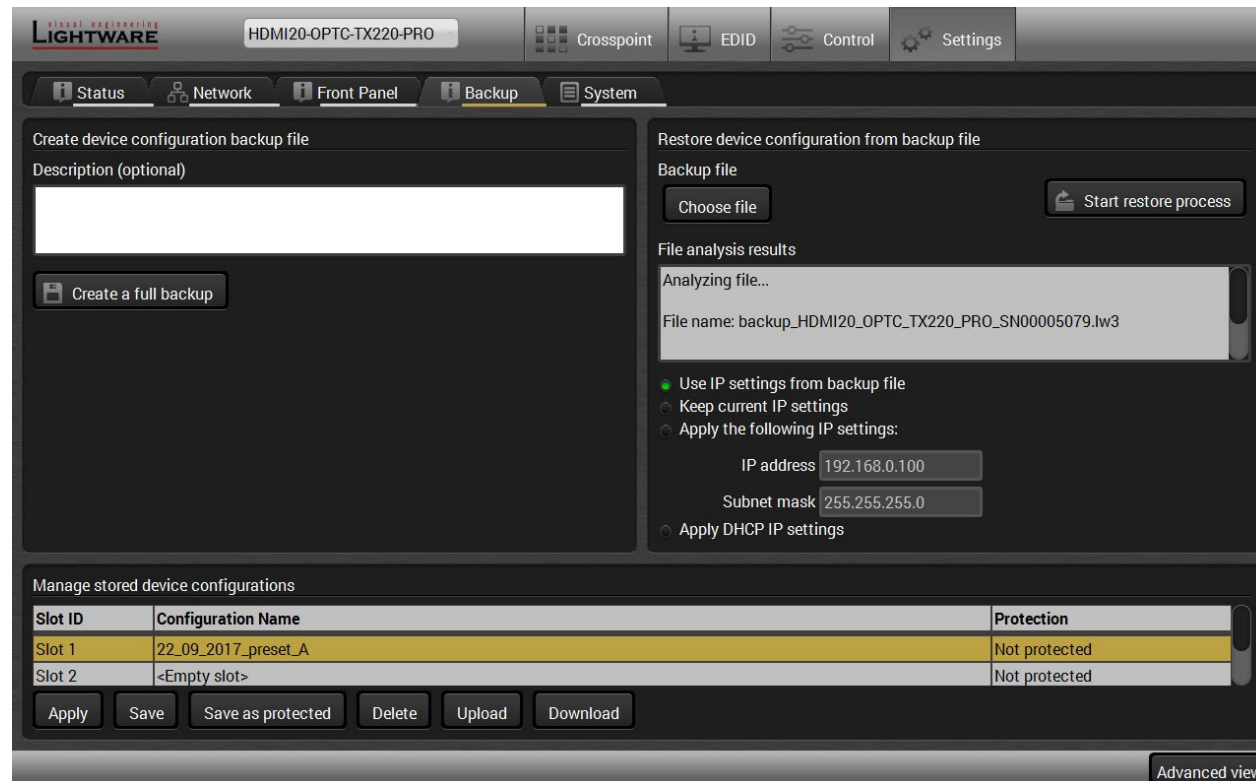

**Backup tab**

The configuration cloning of Lightware LW3 devices is a simple method that eliminates the need to repeatedly configure certain devices to have identical (non-factory) settings. If the devices are installed in the same type of system multiple times then it is enough to set up only one device to fit the user's needs and then copy those settings to the others, thus saving time and resources.

#### Cloning Steps in a Nutshell

Installing multiple devices with the same customized configuration settings can be done in a few easy steps:

- Step 1.** Configure one device with all your desired settings with the LDC software.
- Step 2.** Backup the full configuration file to your computer.
- Step 3.** If needed, make some modifications to the configuration file using a text editor (e.g. Notepad). E.g. modifying the static IP address is needed when DHCP is not used.
- Step 4.** Connect to the other device which has to be configured and upload (restore) your configuration file.
- Step 5.** Done! You can have as many totally identical, customized devices as you like.

#### Save the Settings of the Device (Backup)

- Step 1.** Apply the desired settings in the extender (port parameters, crosspoint, etc.)
- Step 2.** Select the **Settings / Backup** tab from the menu.
- Step 3.** Write a short **description** in the text box on the left (optional).
- Step 4.** Press the **Create a full backup** button. You will be prompted to save the file to the computer. The default file name is the following:

BACKUP\_<DEVICE TYPE>\_SN<SERIAL NUMBER>.LW3

- Step 5.** Set the desired **file name**, select the folder and **save** the file.

**TIPS AND TRICKS:** Using the exact product type in the filename is recommended since it makes the file usage more comfortable.

#### About the Backup File

The backup file is a simple text file which contains LW3 protocol commands. The first line is the description, and the further lines are the commands which will be executed during the restore process. The file can be viewed (and/or edited) by a simple text editor, e.g. Notepad.

**ATTENTION!** Editing the command lines is only recommended for expert users.

#### Upload the Settings to a Device (Restore)

**WARNING!** Please note that the settings will be permanently overwritten with the restored parameters in the device. Withdrawal is not possible.

**ATTENTION!** The cloning is successful when the backup file is downloaded from the same type of source device as the destination device.

#### The Restoring Process

- Step 1.** Select the **Settings / Backup** tab from the menu.
- Step 2.** Click on the **Choose file** button on the right panel and **browse** the desired file.
- Step 3.** The file is checked and the result will be displayed in the textbox below. If the file is correct, the settings can be restored.
- Step 4.** Choose **IP settings** what you want to use after backup. You can apply settings from the backup file, keep actual settings, set it manually in a dialog box or apply DHCP.
- Step 5.** Press the **Start restore process** button and click on the **Yes** button when asked.

### Create and Restore Backups from the Device Memory

HDMI20-OPTC series extenders are able to store backups in their own memory and these can be recalled from there so user does not need to save backup files to the local computer. Four slots are available for this purpose.

Slot ID	Configuration Name	Protection
Slot 1	Preset_0720	Not protected
Slot 2	backup_0125	Protected
Slot 3	<Empty slot>	Not protected
Slot 4	<Empty slot>	Not protected

Buttons: Apply, Save, Save as protected, Delete, Upload, Download

You can save presets as not protected with using **Save** button and as protected with using the **Save as protected** button. To restore a preset select the slot of the desired backup and click on the **Apply** button. You can save presets from a file from your local computer by clicking on the **Upload** button and you can also save a preset from the device's memory to a backup file with using the **Download** button. If you do not need a saved preset any more, select it and click on the **Delete** button.

**WARNING! Loading factory default settings will erase not protected presets which have been saved in the device memory!**

#### 5.8.5. System

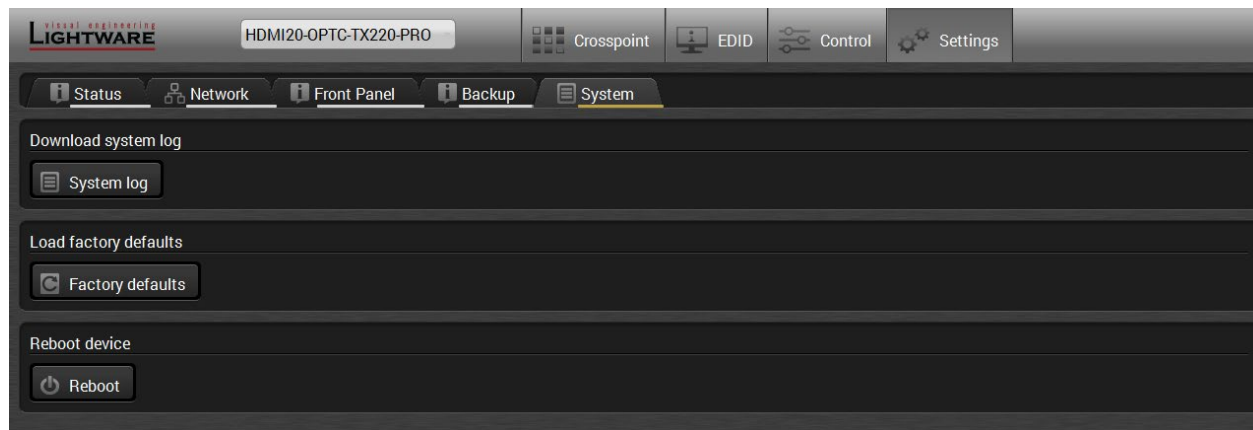

Three functions are available under System tab:

- **Download system log** - saving the log file of the device.
- **Load factory defaults** - recalling factory defaults settings and values. All factory default settings are listed in the [Factory Default Settings](#) section.
- **Reboot** - rebooting the system.

### 5.9. Advanced View Window

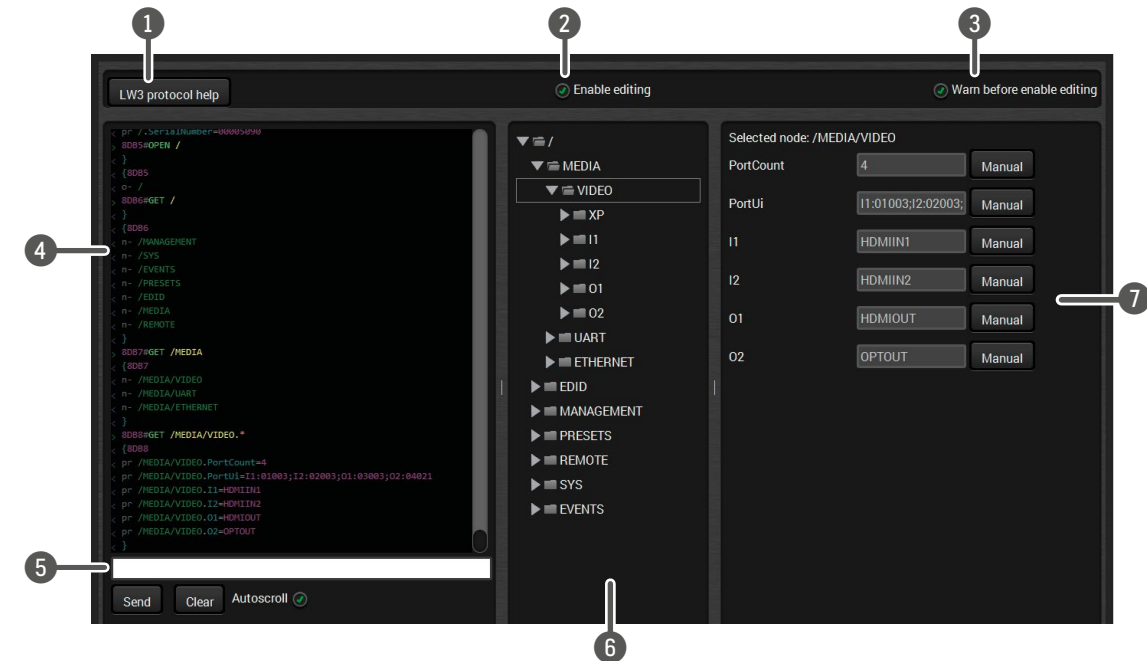

- LW3 protocol help** Pushing the button results a help window opening which describes the most important information about LW3 protocol commands in HTML format.
- Edit mode** The default appearance is the read-only mode. If you want to modify the values or parameters, tick the option. You will be prompted to confirm your selection.
- Warning mode** If this pipe checked in, a warning window pops up when you enable Edit mode.
- Terminal window** Commands and responses with time and date are listed in this window. Sent command starts with '>' character, received response starts with '<' character. The color of each item depends on the type of the command and response. The content of the window can be emptied by the **Clear** button. If the **Autoscroll** option is ticked, the list is scrolled automatically when a new line is added.
- Command line** Type the desired command and execute it by the **Send** button. .
- Protocol tree** LW3 protocol tree; select an item to see its content.
- Node list** Correspondent parameters and nodes are shown which are connected to the selected item in the protocol tree.
  - Manual button:** Manual (short description) of the node can be called and displayed in the terminal window.
  - Set button:** Saves the value/parameter typed in the textbox.
  - Call button:** Calls the method, e.g. reloads factory default settings.

# 6

## LW3 Programmers' Reference

The device can be controlled through Lightware 3 (LW3) protocol commands to ensure the compatibility with other Lightware products. The supported LW3 commands are described in this chapter.

- ▶ OVERVIEW
- ▶ THE TREE STRUCTURE
- ▶ LW3 COMMANDS
- ▶ FORMAL DEFINITIONS
- ▶ SYSTEM COMMANDS
- ▶ VIDEO PORT AND CROSSPOINT SETTINGS
- ▶ NETWORK CONFIGURATION
- ▶ RS-232 PORT CONFIGURATION
- ▶ SENDING MESSAGE VIA THE COMMUNICATION PORTS
- ▶ EDID MANAGEMENT
- ▶ LW3 COMMANDS - QUICK SUMMARY

### 6.1. Overview

The Lightware 3 protocol (LW3) is an ASCII-based, tree-structured protocol that provides outstanding flexibility. The protocol is easy to handle and programmatically still ease to parse, which is suitable for different products with a different feature list.

All commands are terminated with a carriage return (Cr, '\r') and line feed (Lf, '\n') pair. In order to implement a flexible, easy-to-use protocol that is straightforward to adapt to new devices and provides outstanding scalability and sustainability, we decided to organize all settings, parameters and properties of the device to a tree structure with **nodes**, **properties**, and **methods**.

#### 6.1.1. Elements of the Tree Structure

**ATTENTION!** All names and values are case-sensitive. The space character is replaced by the '•' character in the elements and commands descriptions.

##### 6.1.1.1. Node

- The basic building block of the tree structure is the 'node'.
- The node can have multiple child nodes, but only one parent.
- The tree has only one root the 'root node'.
- The leaves of the tree are also nodes, which do not have child nodes.
- The nodes are separated by a slash ('/') character.
- All the slashes are 'right slashes', no backslash is used.
- The identifier of the root node is a slash ('/')
- The node name can contain the elements of the English alphabet and numbers.
- Recommended convention for case sensitivity:
  - Fix nodes (that cannot be altered) are capitalized.
  - User created nodes can contain both lowercase and capital letters, no restrictions.
- The path of a node has to contain all parent nodes from the root node.

Format: (the root node): nX●/

Path: nX●/[nodeName]/[nodeName]/[nodeName]

##### Legend:

n: node

'X' can be:

':': default for a node.

'm': this is a manual for the node.

'E': this is an error message for the node.

's': this is a symlink node.

'v': this node has virtual children.

'r': this is a remote node.

**INFO:** All parent nodes must be listed in the path of a node.

Following example presents the structure of the tree traversal:

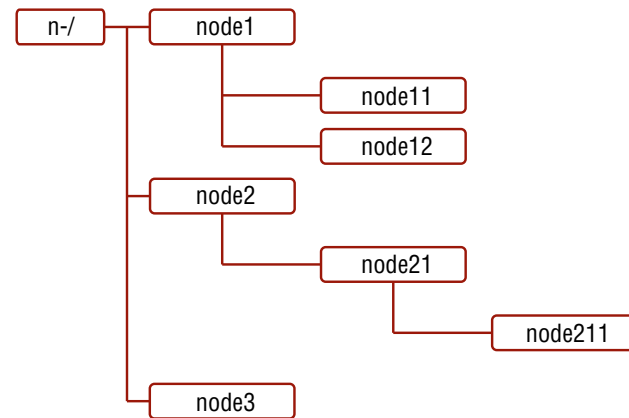

**Tree structure of the nodes**

**Path of the nodes:**

```

n- /node1
n- /node1/node11
n- /node1/node12
n- /node2
n- /node2/node21
n- /node2/node21/node211
n- /node3
  
```

### 6.1.1.2. Property

The 'property' in the LW3 protocol is basically a leaf, which has a well-defined value.

- A property has a value.
- A property cannot have child nodes or child properties. It is always a leaf.
- A node can have any number of properties (may not have any).
- A property is referenced with a dot ('.') after the node name.
- The properties' name can contain the elements of the English alphabet, numbers and underscore ('\_') character.
- By convention, properties are beginning with a capital letter, all other characters are lowercase ones. In the case of compound words, all words are beginning with a capital letter (CamelCase).
- The value of the property can contain any readable ASCII character.
- A property can be read-only or read/write.

**Format:** pX●/[nodeName].[propertyName]=[propertyValue]

**Legend:**

p: property

'X' can be:

'r': if the property is read-only.

'w': if the property is readable, writable.

'm': the manual of the property.

'E': error message for the property.

'v': virtual node property: contains a node path to a node which will be linked to the property's parent node.

**Example:**

The following two ones are read-only properties:

```
m●/node1/node12.ReadOnlyProperty=value1
```

```
m●/.ProductName=HDMI20-OPTC-TX22
```

The following two ones are read-write properties:

```
pw●/node1/node12.ReadWriteProperty=value2
```

```
pw●/.DeviceNickName=John
```

### 6.1.1.3. Method

The 'method' in the LW3 protocol is also a leaf. It cannot have a value, such as the properties, but it can be invoked with a parameter with the help of a special 'CALL' command.

- A method cannot have child nodes or child methods. It is always a leaf.
- A node can have any number of methods (may not have any).
- A method is referenced with a colon (':') after the node.
- The methods' name can contain the elements of the English alphabet, numbers and underscore ('\_') character.
- By convention, methods are beginning with a lowercase letter. In the case of compound words, the very first letter is lowercase, and the first letter of each other words are capitalized (lowerCamelCase).
- The parameter of the method can contain any readable ASCII character.
- The method always has a return 'state' if the method could be executed. The state could be either 'OK' or 'FAILED'.
- The method does not necessarily have a return 'value'. If it does, it can contain additional information, which is always specific to the current case (the return value can specify why the execution failed).
- When the method cannot be executed (e.g. the parameter list is illegal), there is an error message.

**Format:** mX●/[nodeName]:[methodName]=[returnValue]

**Legend:**

m: method

'X' can be:

'O': when the execution of the method was successful (OK).

'F': when the execution of the method failed.

'm': the manual of the method.

'E': error message for the method.

**Example:**

```
mO●/node1/node12:method1
```

```
mO●/MEDIA/XP/VIDEO:switch
```

```
mE●%E001:Syntax error
```

```
mm●/MEDIA/XP/VIDEO:lockSource:Lock one or more source ports
```

### 6.1.2. Escaping

Property values and method parameters can contain characters that are used as control characters in the protocol. They must be escaped. The escape character is the backslash ("\") and escaping means injecting a backslash before the character that should be escaped (like in C language).

Control characters are the followings: \ { } # % ( ) \r \n \t

#### Example:

The original text: John•(Doe).•#3:•5%2=1•node1\node11

The escaped text: John•\ (Doe\).•\#3:•5\%2=1•node1\\node11

### 6.1.3. Error Messages

There are several error messages defined in the LW3 protocol, all of them have a unique error number.

**Format:** XE•[primitive]•%EYYY:•[Error message]

#### Legend:

'X' can be:

'-': syntax error. Cannot parse the command at all.

'n': node error.

'p': property error.

'm': method error.

YYY: error code, which can be one of the followings:

Error code	Name	Default text
000	Lw3ErrorCodes_None	
001	Lw3ErrorCodes_Syntax	Syntax error
002	Lw3ErrorCodes_NotFound	Not found
003	Lw3ErrorCodes_AlreadyExists	Already exists
004	Lw3ErrorCodes_InvalidValue	Invalid value
005	Lw3ErrorCodes_IllegalParamCount	Illegal parameter count
006	Lw3ErrorCodes_IllegalOperation	Illegal operation
007	Lw3ErrorCodes_AccessDenied	Access denied
008	Lw3ErrorCodes_Timeout	Timeout
009	Lw3ErrorCodes_CommandTooLong	Command too long
010	Lw3ErrorCodes_InternalError	Internal error
011	Lw3ErrorCodes_NotImplemented	Not implemented
012	Lw3ErrorCodes_Node_Disabled	Node disabled or standby mode active

### 6.1.4. Prefix Summary

The following prefixes are defined in the LW3 protocol:

'n-': a node,

'nE': an error for a node,

'nm': a manual for a node,

'pr': a read-only property,

'pw': read-write property,

'pE': an error for the property,

'pm': a manual for the property,

'm-': a method,

'mO': a response to a success method execution,

'mF': a response to a failed method execution,

'mE': an error for a method,

'mm': a manual for a method.

## 6.2. The Tree Structure

The /MEDIA node is used by the LDC to connect input ports to output ports on different layers. Each subnode of /MEDIA is representing a layer, e.g. video (/MEDIA/ VIDEO), RS-232 (/MEDIA/ UART) or Ethernet(/MEDIA/ ETHERNET). Each layer has a crosspoint to define connections between the ports associated with the layer, all of them are represented by a specific node. E.g. the video layer node is /MEDIA/VIDEO: under the video layer node, the video crosspoint node (XP) and the video ports (I1, O1, ...) are located. The /SYS node is used for system-related settings such as front panel settings and health status parameters. The /MANAGEMENT node contains network-related parameters, date-time settings, and version numbers. The /EDID node contains all EDID-related settings such as factory pre-programmed EDIDs and User EDIDs. All input and output port settings, crosspoint state, etc... are under the /MEDIA node.

INFO: The tree structure is available in [Advanced View Window](#) the of LDC.

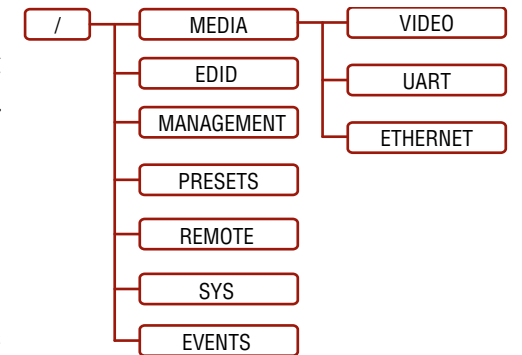



## 6.3. LW3 Commands

### 6.3.1. Get Command

The 'GET' command can be used to get the child nodes, properties and methods of a specific node. It can also be used to get the value of a property.

#### The response format

The first two characters of a response unambiguously identify the type of the element that the response line concerns. The first character is the type of the element (node, property or method), the second is for miscellaneous information (e.g. read/write rights).

The defined prefixes are:

'n-': node  
 'pr': property - only readable  
 'pw': property - writable, readable  
 'm-': method executable

After the prefix, the response contains the full path of the node, property or method after a space character.

#### Get all children of a node

Get all of the child nodes of a parent node, with one GET command.

**Command format:** GET●[nodePath]

**Response format:** n-●[nodePath]

**Example:**

```
> GET /MEDIA
< n- /MEDIA/VIDEO
< n- /MEDIA/UART
< n- /MEDIA/ETHERNET
```

#### Get all child nodes, properties and methods of a node

Get all child nodes, properties and methods of a node with one command, without using a wild card.

**Command format:** GETALL●[nodePath]

**Response format:** (for nodes)

n-●[nodePath]

**Response format:** (for properties)

pX●[nodePath].[propertyName]=[parameter]

**Legend:**

X can be:

'r': read-only  
 'w': read-write

**Response format:** (for methods)

m-●[nodePath]:[methodName]

**Example:**

```
> GETALL /EDID
< n- /EDID/F
< n- /EDID/D
< n- /EDID/U
< n- /EDID/E
< pr /EDID.EdidStatus=D1:E1;D1:E2
< m- /EDID:copy
< m- /EDID:delete
< m- /EDID:reset
< m- /EDID:switch
< m- /EDID:switchAll
```

#### Get all properties and methods of a node

Get all properties and methods of a node, with one GET command and asterisk character.

**Command format:** GET●[nodePath].\*

**Response format:** (for properties)

pX●[nodePath].[propertyName]=[parameter]

**Legend:**

X can be:

'r': read-only  
 'w': read-write

**Response format:** (for methods)

m-●[nodePath]:[methodName]

**Example:**

```
> GET /EDID.*
< pr /EDID.EdidStatus=D1:E1;D1:E2
< m- /EDID:copy
< m- /EDID:delete
< m- /EDID:reset
< m- /EDID:switch
< m- /EDID:switchAll
```

**6.3.2. Set Command**

The setter command can be used to modify the value of a property.

**Command format:** SET●[nodePath].[propertyName]=[newPropertyValue]

**Response format:**

The response for setting a property to a new value is the same as the response for the 'GET' command. The value in the response is the new value if the execution of the 'SET' command was successful, otherwise the unmodified 'old value' with an error message.

pw●[nodePath].[propertyName]=[newPropertyValue]

**Example:**

```
> SET /MANAGEMENT/NETWORK.DhcpEnabled=false
< pw /MANAGEMENT/NETWORK.DhcpEnabled=false
< CHG /MANAGEMENT/NETWORK.DhcpEnabled=false
```

**Error Response format:**

If there were errors during setting a property, an error message follows the unmodified property value.

pE●[nodePath].[propertyName]=[unmodifiedValue]●%E000:Error message

**Legend:** XXX: error number.

**Examples:**

```
> SET /MEDIA/UART/P1.CommandInjectionEnable=2
< pE /MEDIA/UART/P1.CommandInjectionEnable %E004:Invalid value
```

```
> SET /MANAGEMENT/NETWORK.NetworkMask=255.255.255.5
< pE /MANAGEMENT/NETWORK.NetworkMask %E007:Access denied
```

**6.3.3. Invocation**

A method can be invoked with the help of the 'CALL' command.

**Command format:** CALL●[nodePath]:[methodName]([parameter])

**Response format:**

The response for a method execution is a state and a value. The state is mandatory and always defined if the method could be executed. It can be either a success or a failure. The value is optional and it can contain additional information, such as the reason why the state is a failure or a specific value when the state is a success that the client can process. It is also possible to get an error message when the method could not be executed – e.g. the parameter was illegal - and hence not even the state of the execution could be specified.

mX●[nodePath]:[methodName]=Y

**Legend:**

X can be:

'O': if the execution is successful.  
 'F': if the execution is failed, but the method could be executed.  
 'E': if the method could not be executed: e.g. illegal parameter count.

Y can be:

- The return value of the method if any.
- It is valid that a method does not have any return value. In this case, the equal sign (=) can be omitted.

**Example:**

```
> CALL /EDID:switch(D1:E1)
< mO /EDID:switch
```

**Error Response format:**

If there were errors during the execution, an error message is received, which follows the method name.

mE●[nodePath]:[methodName]●%E000:Error message

**Example:**

```
> CALL /EDID:switch(D1:R1)
< mE /EDID:switch %E004: Invalid value
```

### 6.3.4. Manual

For every node, property and method in the tree there is a manual. The manual is a human-readable text that describes the syntax and provides a hint for how to use the primitives.

#### Command format:

for nodes:           MAN●[nodePath]  
for property:        MAN●[nodePath].[propertyName]  
for method:         MAN●[nodePath]:[methodName]

#### Response format:

The human readable manual is separated by a space ( ' ') character from the primitives.

for nodes:           nm●[nodePath]●Human readable manual  
for property:        pm●[nodePath].[propertyName]●Human readable manual  
for method:         mm●[nodePath]:[methodName]●Human readable manual

#### Example: (for a property)

```
> MAN /MEDIA/UART/P1.Baudrate
< pm /MEDIA/UART/P1.Baudrate [<id_of_baudrate>] Baud rate (0=4800; 1=7200; 2=9600;
3=14400; 4=19200; 5=38400; 6=57600; 7=115200)
```

#### Example: (for a method)

```
> MAN /SYS:factoryDefaults
< mm /SYS:factoryDefaults [] Restart the device and set all the settings to factory
default
```

### 6.3.5. Signature

For some command, the response can contain multiple lines. Each line is terminated with a carriage return (Cr, '\r') and line feed (Lf, '\n') characters. In several cases the number of the lines in the response cannot be determined in advance, e.g. the client is intended waiting for the whole response and also wants to be sure, that the received lines belong together and to the same command. In these cases, a special feature the 'signature' can be used.

The signature is a four digit long hexadecimal value that can be optionally placed before every command. In that case, the response to that particular command will also be preceded by the signature, and the corresponding lines will be between brackets.

**Command format:**   XXXX#[command]

**Legend:**        xxxx: 4-digit long hexadecimal value.

#### Response format:

```
{XXXX
[command lines]
}
```

#### Example:

```
> 1103#GET /MEDIA/VIDEO.*
< {1103
< pr /MEDIA/VIDEO.PortCount=4
< pr /MEDIA/VIDEO.PortUi=01:02003;02:03003;I1:01021;03:04003
< pr /MEDIA/VIDEO.01=HDMIOUT1A
< pr /MEDIA/VIDEO.02=HDMIOUT1B
< pr /MEDIA/VIDEO.I1=OPTIN
< pr /MEDIA/VIDEO.03=HDMIOUT2
< }
```

INFO: The lines of the signature are also Cr and Lf terminated.

### 6.3.6. Subscription

The user can subscribe to any node. Subscribe to a node means that the user will get a notification if any of the properties of the node is changed. These notifications are asynchronous messages - such as the ones described above - and hence, they are useful to keep the client application up-to-date, without receiving any unwanted information. When the user does not want to be informed about the changes anymore, he can simply unsubscribe from the node.

**ATTENTION!** The subscriptions are handled separately for connections. Hence, if the connection is terminated all registered subscriptions are deleted. After closing a connection the subscribe command has to be sent in order to get the notifications of the changes on that connection.

#### Subscribe to a node

**Command format:**   OPEN●[nodePath]

**Response format:**   o-●[nodePath]

#### Example:

```
> OPEN /MEDIA/VIDEO
< o- /MEDIA/VIDEO
```

#### Subscribe to multiple nodes

In order to subscribe to multiple nodes, the asterisk wild card can be used.

**Command format:**   OPEN●[nodePath]/\*

**Response format:**   o-●[nodePath]/\*

#### Example:

```
> OPEN /MEDIA/VIDEO/*
< o- /MEDIA/VIDEO/*
```

**Get the active subscriptions for the current connection****Command format:** OPEN**Response format:** o-•[nodePath]

Example:

```
> OPEN
< o- /MEDIA/VIDEO/XP
< os /MEDIA/VIDEO/I1
< os /MEDIA/VIDEO/I2
< o- /MEDIA/VIDEO
< os /REMOTE/D1
< o- /MANAGEMENT/UID
< o- /
```

**Unsubscribe from a node****Command format:** CLOSE•[nodePath]**Response format:** c-•[nodePath]

Example:

```
> CLOSE /MEDIA/VIDEO
< c- /MEDIA/VIDEO
```

**Unsubscribe from multiple nodes****Command format:** CLOSE•[nodePath]/\***Response format:** c-•[nodePath]/\*

Example:

```
> CLOSE /MEDIA/VIDEO/*
< c- /MEDIA/VIDEO/*
```

**6.3.7. Notifications about the Changes of the Properties**

When the value of a property is changed and the user is subscribed to the node, which the property belongs to, an asynchronous notification is generated. This is notification is called as the 'change message'. The format of such a message is very similar to the response for the 'GET' command.

**Format:** CHG•[nodePath].[propertyName]=[newPropertyValue]

Example:

```
< CHG /MEDIA/VIDEO/01.ForcedSignalType=HDMI
```

**A short example of how to use the subscription**

In the following, an example is presented, how the subscriptions are working and how to use them. In the example, there are two independent users controlling the device through two independent connections ('Connection #1' and 'Connection #2'). The events in the rows occur after each other.

```
Conn. #1 > OPEN /MEDIA/VIDEO/XP
          < o- /MEDIA/VIDEO/XP
          > GET /MEDIA/VIDEO/XP.DestinationConnectionList
          < pr /MEDIA/VIDEO/XP.DestinationConnectionList=I1;I1
          > GET /MEDIA/VIDEO/XP.DestinationConnectionList
          < pr /MEDIA/VIDEO/XP.DestinationConnectionList=I1;I1
Conn. #2 > CALL /MEDIA/VIDEO/XP:switch(I2:01)
          < mO /MEDIA/VIDEO/XP:switch
Conn. #1 < CHG /MEDIA/VIDEO/XP.DestinationConnectionList=I2;I2
```

**Explanation:** The first user (Connection #1) set a subscription to a node. Later the other user (Connection #2) made a change, and thanks for the subscription, the first user got a notification about the change.

**6.4. Formal Definitions**

Method parameters and property values are specified in a modified version of Backus-Naur Form (BNF). The syntax is the following:

"literal"	literals are quoted
<expression1> <expression2>	vertical bars denote alternatives
[<expression>]	expressions in square brackets are optional
<number>*<expression>	expression is repeated at least <number> times
*<expression>	<number> may be omitted, in this case number defaults to 0
<number>*<expression>}	expressions in curly brackets are repeated exactly <number> times
In	Input port number
Om	Output port number

## 6.5. System Commands

### 6.5.1. Querying the Product Name

The name of the product is a read-only parameter and cannot be modified.

**Command format:** GET●/.ProductName

**Response format:** pr●/.ProductName=<Product\_name>

**Example:**

```
> GET /.ProductName
< pr /.ProductName=HDMI20-OPTC-TX220-PRO
```

### 6.5.2. Setting the Device Label

**ATTENTION!** The device label can be changed to a custom text which is displayed in many windows of the LDC. This writable parameter is not the same as the ProductName parameter.

**Command format:** SET●/MANAGEMENT/UID/DeviceLabel=<Custom\_name>

**Response format:** pw●/MANAGEMENT/UID/DeviceLabel=<Custom\_name>

The Device Label can be 39 character length and ASCII characters are allowed. Longer names are truncated.

**Example:**

```
> SET /MANAGEMENT/UID.DeviceLabel=HDM20-OPTC_Control_room
< pw /MANAGEMENT/UID.DeviceLabel=HDM20-OPTC_Control_room
```

### 6.5.3. Querying the Serial Number

**Command format:** GET●/.SerialNumber

**Response format:** pr●/.SerialNumber=<serial\_nr>

**Example:**

```
> GET /.SerialNumber
< pr /.SerialNumber=92345083
```

### 6.5.4. Querying the Firmware Version

**Command format:** GET●/SYS/MB.FirmwareVersion

**Response format:** pr●/SYS/MB.FirmwareVersion=<firmware\_version>

**Example:**

```
> GET /SYS/MB.FirmwareVersion
< pr /SYS/MB.FirmwareVersion=1.0.0b9 r9
```

### 6.5.5. Resetting the Extender

The extender can be restarted – the current connections (LAN, RS-232) will be terminated.

**Command format:** CALL●/SYS:reset()

**Response format:** mO●/SYS:reset=

**Example:**

```
> CALL /SYS:reset()
< mO /SYS:reset=
```

### 6.5.6. Restoring the Factory Default Settings

**Command format:** CALL●/SYS:factoryDefaults()

**Response format:** mO●/SYS:factoryDefaults=

**Example:**

```
> CALL /SYS:factoryDefaults()
< mO /SYS:factoryDefaults=
```

### 6.5.7. Locking Front Panel

**Command format:** SET●/MANAGEMENT/UI.ControlLock=0|1|2

**Response format:** pw●/MANAGEMENT/UI.ControlLock=0|1|2

**Example:**

```
> SET /MANAGEMENT/UI.ControlLock=1
< pw /MANAGEMENT/UI.ControlLock=1
```

**Legend:**

- 0: None - All functions of the front panel button are enabled.
- 1: Locked - The front panel button is locked.
- 2: Force Locked - The front panel button is locked and unlock is only possible via protocol command.

### 6.5.8. Enabling Dark Mode

**Command format:** SET●/MANAGEMENT/UI.DARKMODE.DarkModeEnable=true|false

**Response format:** pw●/MANAGEMENT/UI.DARKMODE.DarkModeEnable=true|false

**Example:**

```
> SET /MANAGEMENT/UI/DARKMODE.DarkModeEnable=true
< pw /MANAGEMENT/UI/DARKMODE.DarkModeEnable=true
```

**Explanation:** The LEDs and the brightness of LCD display on the extender are turned off.

### 6.5.9. Setting the Dark Mode Delay

The LEDs turn off after the dark mode is enabled. The delay time can be set (the default value is 60s).

**Command format:** SET●/MANAGEMENT/UI.DARKMODE.DarkModeDelay=<delay\_sec>

**Response format:** pw●/MANAGEMENT/UI.DARKMODE.DarkModeDelay=<delay\_sec>

**Example:**

```
> SET /MANAGEMENT/UI/DARKMODE.DarkModeDelay=10
< pw /MANAGEMENT/UI/DARKMODE.DarkModeDelay=10
```

**Explanation:** When dark mode is enabled, the LEDs are turned off after 10s.

### 6.5.10. Setting the Dark Mode on the Remote Device

INFO: This command is available for HDMI20-OPTC-TX220-Pro model.

Dark mode on the receiver can be activated by sending a command to the transmitter.

**Command format:** SET●/REMOTE/D1.DarkModeEnable=true|false

**Response format:** pw●/REMOTE/D1.DarkModeEnable=true|false

**Example:**

```
> SET /REMOTE/D1.DarkModeEnable=true
< pw /REMOTE/D1.DarkModeEnable=true
```

**Explanation:** LEDs on the receiver are turned off.

### 6.5.11. Setting the Rotary Direction of the Jog Dial Knob

**Command format:** SET●/MANAGEMENT/UI.RotaryDirection=0|1

**Response format:** pw●/MANAGEMENT/UI.RotaryDirection=0|1

**Example:**

```
> SET /MANAGEMENT/UI.RotaryDirection=0
< pw /MANAGEMENT/UI.RotaryDirection=0
```

**Legend:**

- 0: The rotary direction of down is clockwise.
- 1: The rotary direction of down is counter clockwise.

## 6.6. Video Port and Crosspoint Settings

### 6.6.1. Querying the Crosspoint Setting

**Command format:** GET●/MEDIA/VIDEO/XP.DestinationConnectionList

**Response format:** pr●/MEDIA/VIDEO/XP.DestinationConnectionList=<O1\_state>;<O2\_state>

**Example:**

```
> GET /MEDIA/VIDEO/XP.DestinationConnectionList
< pr /MEDIA/VIDEO/XP.DestinationConnectionList=I1;I1
```

**Explanation:** I1 input port is connected to all output ports.

### 6.6.2. Switching Video Input

**Command format:** CALL●/MEDIA/VIDEO/XP:switch(<In>:<Om>)

**Response format:** mO●/MEDIA/VIDEO/XP:switch

**Example:**

```
> CALL /MEDIA/VIDEO/XP:switch(I1:O1)
< mO /MEDIA/VIDEO/XP:switch
```

### 6.6.3. Querying the Status of Source Ports

**Command format:** GET●/MEDIA/VIDEO/XP.SourcePortStatus

**Response format:** pr●/MEDIA/VIDEO/XP.SourcePortStatus=[<I<sub>1</sub>><I<sub>2</sub>>]

The response contains 5 ASCII characters for each port. The first character indicates the mute/lock state, the next four characters represent a 2-byte HEX code showing the current state of the input ports.

**Example:**

```
> GET /MEDIA/VIDEO/XP.SourcePortStatus
< pr /MEDIA/VIDEO/XP.SourcePortStatus=T008F;T008A
```

**Legend:**

Letter (Character 1)		
	Mute state	Lock state
T	Unmuted	Unlocked
L	Unmuted	Locked
M	Muted	Unlocked
U	Muted	Locked

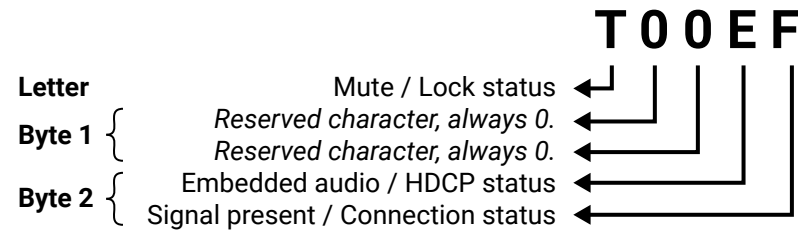

	Byte 1				Byte 2			
	Character 2		Character 3		Character 4		Character 5	
	BIT 7-6	BIT 5-4	BIT 3-2	BIT 1-0	BIT 7-6	BIT 5-4	BIT 3-2	BIT 1-0
	Reserved	Reserved	Reserved	Reserved	Embedded audio status	HDCP status	Signal present status	Connection status
00	Reserved	Reserved	Reserved	Reserved	Unknown			
01					Reserved			
10					No embedded audio	Not encrypted	No signal	Not connected
11					Embedded audio presents	Encrypted	Signal presents	Connected

**Example and Explanation (T008F):**

T	0		0		8		F	
Unlocked, Unmuted	00	00	00	00	10	00	11	11
	Reserved	Reserved	Reserved	Reserved	No embedded audio	Unknown	Signal presents	Connected

### The Most Common Received Port Status Responses

T00AA	T	0		0		A		A	
	Unlocked, Unmuted	00	00	00	00	10	10	10	10
	Reserved	Reserved	Reserved	Reserved	No embedded audio	Not encrypted	No signal	Not connected	

T00AB	T	0		0		A		B	
	Unlocked, Unmuted	00	00	00	00	10	10	10	11
	Reserved	Reserved	Reserved	Reserved	No embedded audio	Not encrypted	No signal	Connected	

T00AF	T	0		0		A		F	
	Unlocked, Unmuted	00	00	00	00	10	10	11	11
	Reserved	Reserved	Reserved	Reserved	No embedded audio	Not encrypted	Signal presents	Connected	

T00EF	T	0		0		E		F	
	Unlocked, Unmuted	00	00	00	00	11	10	11	11
	Reserved	Reserved	Reserved	Reserved	Embedded audio presents	Not encrypted	Signal presents	Connected	

T00BF	T	0		0		B		F	
	Unlocked, Unmuted	00	00	00	00	10	11	11	11
	Reserved	Reserved	Reserved	Reserved	No embedded audio	Encrypted	Signal presents	Connected	

T00FF	T	0		0		F		F	
	Unlocked, Unmuted	00	00	00	00	11	11	11	11
	Reserved	Reserved	Reserved	Reserved	Embedded audio presents	Encrypted	Signal presents	Connected	

#### 6.6.4. Querying the Status of Destination Ports

**Command format:** GET●/MEDIA/VIDEO/XP.DestinationPortStatus

**Response format:** pr●/MEDIA/VIDEO/XP.DestinationPortStatus=[<O<sub>1</sub>><O<sub>2</sub>>]

The response contains 5 ASCII characters for each port. The first character indicates the mute/lock state, the next 2-byte long HEX code showing the current state of the output port.

**Example:**

```
> GET /MEDIA/VIDEO/XP.DestinationPortStatus
< pr /MEDIA/VIDEO/XP.DestinationPortStatus=T008E;M008E
```

**Legend:** See at previous section.

**Example:**

M	O		O		8		E	
Unlocked, Muted	00	00	00	00	10	00	11	10
	Reserved	Reserved	Reserved	Reserved	No embedded audio	Unknown	Signal presents	Connected

#### 6.6.5. Muting Input Port

**Command format:** CALL●/MEDIA/VIDEO/XP:muteSource(<I<sub>n</sub>>)

**Response format:** mO●/MEDIA/VIDEO/XP:muteSource

**Example:**

```
> CALL /MEDIA/VIDEO/XP:muteSource(I1)
< mO /MEDIA/VIDEO/XP:muteSource
```

#### 6.6.6. Unmuting Input Port

**Command format:** CALL●/MEDIA/VIDEO/XP:unmuteSource(<I<sub>n</sub>>)

**Response format:** mO●/MEDIA/VIDEO/XP:unmuteSource

**Example:**

```
> CALL /MEDIA/VIDEO/XP:unmuteSource(I1)
< mO /MEDIA/VIDEO/XP:unmuteSource
```

#### 6.6.7. Locking Input Port

**Command format:** CALL●/MEDIA/VIDEO/XP:lockSource(<I<sub>n</sub>>)

**Response format:** mO●/MEDIA/VIDEO/XP:lockSource

**Example:**

```
> CALL /MEDIA/VIDEO/XP:lockSource(I1)
< mO /MEDIA/VIDEO/XP:lockSource
```

#### 6.6.8. Unlocking Input Port

**Command format:** CALL●/MEDIA/VIDEO/XP:unlockSource(<I<sub>n</sub>>)

**Response format:** mO●/MEDIA/VIDEO/XP:unlockSource

**Example:**

```
> CALL /MEDIA/VIDEO/XP:unlockSource(I1)
< mO /MEDIA/VIDEO/XP:unlockSource
```

#### 6.6.9. Querying the Video Autoselect Settings

**Command format:** GET●/MEDIA/VIDEO/XP.DestinationPortAutoselect

**Response format:** pr●/MEDIA/VIDEO/XP.DestinationPortAutoselect=<O<sub>1</sub>\_set>; <O<sub>2</sub>\_set>

The response shows the settings of output1 and output2.

**Example:**

```
> GET /MEDIA/VIDEO/XP.DestinationPortAutoselect
< pr /MEDIA/VIDEO/XP.DestinationPortAutoselect=EP;EP
```

**Legend:**

Letter	Explanation	
1 <sup>st</sup> letter	E:	Autoselect is enabled.
	D:	Autoselect is disabled.
2 <sup>st</sup> letter	F:	First detect mode: the first active video input is selected.
	P:	Priority detect mode: always the highest priority active video input will be selected.
	L:	Last detect mode: always the last attached input is switched to the output automatically.

**Explanation:**

EP: the Autoselect is Enabled on output 1 and output 2, selected mode is Priority detect.



### 6.6.10. Changing the Autoselect Mode

**Command format:** CALL●/MEDIA/VIDEO/XP:setDestinationPortAutoselect(<O<sub>n</sub>>:<On\_set>)

**Response format:** mO●/MEDIA/VIDEO/XP:setDestinationPortAutoselect

**Example1:**

```
> CALL /MEDIA/VIDEO/XP:setDestinationPortAutoselect(02:D)
< m0 /MEDIA/VIDEO/XP:setDestinationPortAutoselect
```

**Legend:** See the previous legend.

**Explanation:** D: the Autoselect is disabled on output 2.

**Example2:**

```
> CALL /MEDIA/VIDEO/XP:setDestinationPortAutoselect(01:EF)
< m0 /MEDIA/VIDEO/XP:setDestinationPortAutoselect
```

**Legend:** See previous legend.

**Explanation:** EF: First priority detect is set on output 1.

### 6.6.11. HDCP Setting

This setting allows to send non-encrypted content to a non-HDCP compliant display. See more information in [HDCP Management](#) section.

**Command format:** SET●/MEDIA/VIDEO/<In>.HdcpVersion=0|1|2

**Response format:** pw●/MEDIA/VIDEO/<In>.HdcpVersion=0|1|2

**Legend:**

Value	Description
0	Disable HDCP on input
1	Allow HDCP 1.4 only
2	Allow HDCP 2.2 and HDCP 1.4

**Example:**

```
> SET /MEDIA/VIDEO/I1.HdcpVersion=0
< pw /MEDIA/VIDEO/I1.HdcpVersion=0
```

### 6.6.12. Setting the Output Conversion Mode

INFO: This command is available on the O1 output of HDMI20-OPTC-RX220-Pro model.

**Command format:** SET●/MEDIA/VIDEO/O1.Conversion=OFF|420|LEFT|RIGHT

**Response format:** mO●/MEDIA/VIDEO/O1.Conversion=OFF|420|LEFT|RIGHT

**Example:**

```
> SET /MEDIA/VIDEO/O1.Conversion=420
< pw /MEDIA/VIDEO/O1.Conversion=420
```

**Legend:**

- **OFF:** No conversion mode (transparent)
- **420:** Converts to YCbCr 4:2:0
- **LEFT:** Split mode, output on the left side
- **RIGHT:** Split mode, output on the right side

**Explanation:** HDMI signal on the O1A and O1B of the receiver is downsampled to YCbCr 4:2:0. For more information see [Output Conversion Modes](#) section.

### 6.6.13. Setting the Output Conversion Mode of the Remote Device

INFO: This command is available for HDMI20-OPTC-TX220-Pro model.

Output conversion mode on the O1A and O1B ports of the receiver can be also set by sending a command to the transmitter.

**Command format:** SET●/REMOTE/D1.Conversion=OFF|420|LEFT|RIGHT

**Response format:** pw●/REMOTE/D1.Conversion=OFF|420|LEFT|RIGHT

**Example:**

```
> SET /REMOTE/D1.Conversion=LEFT
< pw /REMOTE/D1.Conversion=LEFT
```

**Legend:** See previous legend.

**Explanation:** HDMI signal is splitted on the O1A (left) and O1B (right) ports of the receiver. For more information see [Output Conversion Modes](#) section.

## 6.7. Network Configuration

### 6.7.1. Querying the IP Address

**Command format:** GET●/MANAGEMENT/NETWORK.IpAddress

**Response format:** pr●/MANAGEMENT/NETWORK.IpAddress=<IP\_Address>

**Example:**

```
> GET /MANAGEMENT/NETWORK.IpAddress
< pr /MANAGEMENT/NETWORK.IpAddress=192.168.0.101
```

### 6.7.2. Changing the IP Address (Static)

**Command format:** SET●/MANAGEMENT/NETWORK.StaticIpAddress=<IP\_address>

**Response format:** pw●/MANAGEMENT/NETWORK.StaticIpAddress=<IP\_address>

**Example:**

```
> SET /MANAGEMENT/NETWORK.StaticIpAddress=192.168.0.103
< pw /MANAGEMENT/NETWORK.StaticIpAddress=192.168.0.103
```

### 6.7.3. Querying the Subnet Mask

**Command format:** GET●/MANAGEMENT/NETWORK.NetworkMask

**Response format:** pr●/MANAGEMENT/NETWORK.NetworkMask=<netmask>

**Example:**

```
> GET /MANAGEMENT/NETWORK.NetworkMask
< pr /MANAGEMENT/NETWORK.NetworkMask=255.255.255.0
```

### 6.7.4. Changing the Subnet Mask (Static)

**Command format:** SET●/MANAGEMENT/NETWORK.StaticNetworkMask=<netmask>

**Response format:** pw●/MANAGEMENT/NETWORK.StaticNetworkMask=<netmask>

**Example:**

```
> SET /MANAGEMENT/NETWORK.StaticNetworkMask=255.255.255.0
< pw /MANAGEMENT/NETWORK.StaticNetworkMask=255.255.255.0
```

### 6.7.5. Querying the Gateway Address

**Command format:** GET●/MANAGEMENT/NETWORK.GatewayAddress

**Response format:** pr●/MANAGEMENT/NETWORK.GatewayAddress=<gw\_address>

**Example:**

```
> GET /MANAGEMENT/NETWORK.GatewayAddress
< pr /MANAGEMENT/NETWORK.GatewayAddress=192.168.0.1
```

### 6.7.6. Changing the Gateway Address (Static)

**Command format:** SET●/MANAGEMENT/NETWORK.StaticGatewayAddress=<gw\_address>

**Response format:** pw●/MANAGEMENT/NETWORK.StaticGatewayAddress=<gw\_address>

**Example:**

```
> SET /MANAGEMENT/NETWORK.StaticGatewayAddress=192.168.0.5
< pw /MANAGEMENT/NETWORK.StaticGatewayAddress=192.168.0.5
```

### 6.7.7. Querying the DHCP State

**Command format:** GET●/MANAGEMENT/NETWORK.DhcpEnabled

**Response format:** pw●/MANAGEMENT/NETWORK.DhcpEnabled=true|false

**Example:**

```
> GET /MANAGEMENT/NETWORK.DhcpEnabled
< pw /MANAGEMENT/NETWORK.DhcpEnabled=true
```

### 6.7.8. Changing the DHCP State

**Command format:** SET●/MANAGEMENT/NETWORK.DhcpEnabled=true|false

**Response format:** pw●/MANAGEMENT/NETWORK.DhcpEnabled=true|false

**Example:**

```
> SET /MANAGEMENT/NETWORK.DhcpEnabled=false
< pw /MANAGEMENT/NETWORK.DhcpEnabled=false
```

### 6.7.9. Enabling Ethernet Port

**Command format:** SET●/MEDIA/ETHERNET/<P<sub>n</sub>>.Enabled=true|false

**Response format:** pw●/MEDIA/ETHERNET/<P<sub>n</sub>>.Enabled=true|false

**Example:**

```
> SET /MEDIA/ETHERNET/P2.Enabled=false
< pw /MEDIA/ETHERNET/P2.Enabled=false
```

**Explanation:** Disabled the P2 Ethernet port.

## 6.8. RS-232 Port Configuration

### 6.8.1. Querying the RS-232 Operation Mode

**Command format:** GET●/MEDIA/UART/<P<sub>1</sub>>.Rs232Mode

**Response format:** pw●/MEDIA/UART/<P<sub>1</sub>>.Rs232Mode

**Legend:**

- 0: Pass-through
- 1: Control (local)
- 2: Command injection (local)

**Example:**

```
> GET /MEDIA/UART/P1.Rs232Mode
< pw /MEDIA/UART/P1.Rs232Mode
```

### 6.8.2. Setting the RS-232 Operation Mode

**Command format:** SET●/MEDIA/UART/<P<sub>1</sub>>.Rs232Mode=0|1|2

**Response format:** pw●/MEDIA/UART/<P<sub>1</sub>>.Rs232Mode=0|1|2

**Legend:** See the previous legend.

**Example:**

```
> SET /MEDIA/UART/P1.Rs232Mode=1
< pw /MEDIA/UART/P1.Rs232Mode=1
```

### 6.8.3. Setting the BAUD Rate

**Command format:** SET●/MEDIA/UART/<P<sub>1</sub>>.Baudrate=0|1|2|3|4|5|6|7

**Response format:** pw●/MEDIA/UART/<P<sub>1</sub>>.Baudrate=0|1|2|3|4|5|6|7

**Parameters:**

.Baudrate	0	1	2	3	4	5	6	7
BAUD rate value	4800	7200	9600	14400	19200	38400	57600	115200

**Example:**

```
> SET /MEDIA/UART/P1.Baudrate=2
< pw /MEDIA/UART/P1.Baudrate=2
```

### 6.8.4. Setting the Databit

**Command format:** SET●/MEDIA/UART/<P<sub>1</sub>>.DataBits=8|9

**Response format:** pw●/MEDIA/UART/<P<sub>1</sub>>.DataBits=8|9

**Example:**

```
> SET /MEDIA/UART/P1.DataBits=8
< pw /MEDIA/UART/P1.DataBits=8
```

### 6.8.5. Setting the Stopbits

**Command format:** SET●/MEDIA/UART/<P<sub>1</sub>>.StopBits=0|1|2

**Response format:** pw●/MEDIA/UART/<P<sub>1</sub>>.StopBits=0|1|2

**Parameters:**

.StopBits	0	1	2
Stopbit value	1	1,5	2

**Example:**

```
> SET /MEDIA/UART/P1.StopBits=0
< pw /MEDIA/UART/P1.StopBits=0
```

### 6.8.6. Setting the Parity

**Command format:** SET●/MEDIA/UART/<P<sub>1</sub>>.Parity=0|1|2

**Response format:** pw●/MEDIA/UART/<P<sub>1</sub>>.Parity=0|1|2

**Parameters:**

.Parity	0	1	2
Parity setting	no parity	odd	even

**Example:**

```
> SET /MEDIA/UART/P1.Parity=0
< pw /MEDIA/UART/P1.Parity=0
```

### 6.8.7. Enabling Command Injection Mode

**Command format:** SET●/MEDIA/UART/<P<sub>1</sub>>.CommandInjectionEnable=true|false

**Response format:** pw●/MEDIA/UART/<P<sub>1</sub>>.CommandInjectionEnable=true|false

**Example:**

```
> SET /MEDIA/UART/P1.CommandInjectionEnable=true
< pw /MEDIA/UART/P1.CommandInjectionEnable=true
```

**ATTENTION!** The Command injection status is stored in another read-only property: /MEDIA/UART/<P<sub>1</sub>>.CommandInjectionStatus.

## 6.9. Sending Message via the Communication Ports

### 6.9.1. Sending Message via an RS-232 Port

The RS-232 ports can be used for sending a command message to a device which can be controlled over serial port. Both local RS-232 and extended link RS-232 ports can be used. The three different commands allow to use different message formats.

#### Sending Message

The command is for sending a command messages in ASCII-format with an option for escaping special characters.

**Command format:** CALL●/MEDIA/UART/<P<sub>1</sub>>.sendMessage(<message>)

**Response format:** mO●/MEDIA/UART/<P<sub>1</sub>>.sendMessage

**Example:**

```
> CALL /MEDIA/UART/P1:sendMessage(PWR0\x0d\x0a)
< mO /MEDIA/UART/P1:sendMessage
```

#### Escaping in the Message

When commands need to be separated by <CR><LF> characters to be recognized by the controlled device, then they need to be escaped. You can use the following format for escaping:

<command<sub>1</sub>><\x0d\x0a><command<sub>2</sub>><\x0d\x0a>...<command<sub>n</sub>><\x0d\x0a>

See more details in [Escaping](#) section.

#### Sending Text Message

The command is for sending a text message in ASCII-format.

**INFO:** Escaping will not be processed using the **sendText** command.

**Command format:** CALL●/MEDIA/UART/<P<sub>1</sub>>.sendText(<message>)

**Response format:** mO●/MEDIA/UART/<P<sub>1</sub>>.sendText

**Example:**

```
> CALL /MEDIA/UART/P1:sendText(pwr_on)
< mO /MEDIA/UART/P1:sendText
```

### Sending Binary Message

The command is for sending a binary message in HEX format.

**Command format:** CALL●/MEDIA/UART/<P<sub>1</sub>>.sendBinaryMessage(<message>)

**Response format:** mO●/MEDIA/UART/<P<sub>1</sub>>.sendBinaryMessage

**Example:**

```
> CALL /MEDIA/UART/P1:sendBinaryMessage(110000006162000cdcc2c40)
< mO /MEDIA/UART/P1:sendBinaryMessage
```

### 6.9.2. Sending Message via TCP Port

The device can be used for sending a message to a certain IP:port address. The three different commands allow controlling the connected (third-party) devices.

#### Sending TCP Message

The command is for sending a command messages in ASCII-format with an option for escaping special characters.

**Command format:** CALL●/MEDIA/ETHERNET:tcpMessage(<IP\_address>:<port\_no>=<message>)

**Response format:** mO●/MEDIA/ETHERNET:tcpMessage

**Example:**

```
> CALL /MEDIA/ETHERNET:tcpMessage(192.168.0.20:5555=PWR0\x0d\x0a)
< mO /MEDIA/ETHERNET:tcpMessage
```

#### Escaping in the Message

When commands need to be separated by <CR><LF> characters to be recognized by the controlled device, then they need to be escaped. You can use the following format for escaping:

<command<sub>1</sub>><\x0d\x0a><command<sub>2</sub>><\x0d\x0a>...<command<sub>n</sub>><\x0d\x0a>

See more details in [Escaping](#) section.

**Sending Text Message**

The command is for sending a text message in ASCII-format.

INFO: Escaping will not be processed using the **tcpText** command.

**Command format:** CALL●/MEDIA/ETHERNET:tcpText(<IP\_address>:<port\_no>=<message>)

**Response format:** mO●/MEDIA/ETHERNET:tcpText

**Example:**

```
> CALL /MEDIA/ETHERNET:tcpText(192.168.0.20:5555=pwr_on)
< mO /MEDIA/ETHERNET:tcpText
```

**Sending Binary Message**

The command is for sending a binary message in HEX format.

**Command format:** CALL●/MEDIA/ETHERNET:tcpBinary(<IP\_address>:<port\_no>=<message>)

**Response format:** mO●/MEDIA/ETHERNET:tcpBinary

**Example:**

```
> CALL /MEDIA/ETHERNET:tcpBinary(192.168.0.20:5555=0100000061620000cdcc2c40)
< mO /MEDIA/ETHERNET:tcpBinary
```

**6.9.3. Sending Message via UDP Port**

The device can be used for sending a message to a certain IP:port address. The three different commands allow controlling the connected (third-party) devices.

**Sending UDP Message**

The command is for sending a command messages in ASCII-format with an option for escaping special charaters.

**Command format:** CALL●/MEDIA/ETHERNET:udpMessage(<IP\_address>:<port\_no>=<message>)

**Response format:** mO●/MEDIA/ETHERNET:udpMessage

**Example:**

```
> CALL /MEDIA/ETHERNET:udpMessage(192.168.0.20:5555=PWR0\x0d\x0a)
< mO /MEDIA/ETHERNET:udpMessage
```

**Escaping in the Message**

When commands need to be separated by <CR><LF> charaters to be recognized by the controlled device, then they need to be escaped. You can use the following format for escaping:

<command<sub>1</sub>><\x0d\x0a><command<sub>2</sub>><\x0d\x0a>...<command<sub>n</sub>><\x0d\x0a>

See more details in [Escaping](#) section.

**Sending Text Message**

The command is for sending a text message in ASCII-format.

INFO: Escaping will not be processed using the **udpText** command.

**Command format:** CALL●/MEDIA/ETHERNET:udpText(<IP\_address>:<port\_no>=<message>)

**Response format:** mO●/MEDIA/ETHERNET:udpText

**Example:**

```
> CALL /MEDIA/ETHERNET:udpText(192.168.0.20:5555=pwr_on)
< mO /MEDIA/ETHERNET:udpText
```

**Sending Binary Message**

The command is for sending a binary message in HEX format.

**Command format:** CALL●/MEDIA/ETHERNET:udpBinary(<IP\_address>:<port\_no>=<message>)

**Response format:** mO●/MEDIA/ETHERNET:udpBinary

**Example:**

```
> CALL /MEDIA/ETHERNET:udpBinary(192.168.0.20:5555=0100000061620000cdcc2c40)
< mO /MEDIA/ETHERNET:udpBinary
```

## 6.10. EDID Management

### 6.10.1. Querying the Emulated EDIDs

**Command format:** GET●/EDID.EdidStatus

**Response format:** pr●/EDID.EdidStatus=<E\_loc>:<E<sub>1</sub>>;<E\_loc>:<E<sub>2</sub>>

**Example:**

```
> GET /EDID.EdidStatus
< pr /EDID.EdidStatus=D1:E1;D1:E2
```

**Explanation:**

Dynamic EDID was emulated for both input port.

### 6.10.2. Querying the Validity of a Dynamic EDID

**Command format:** GET●/EDID/D/D<sub>n</sub>.Validity

**Response format:** pr●/EDID/D/D<sub>n</sub>.Validity=true|false

**Example:**

```
> GET /EDID/D/D1.Validity
< pr EDID/D/D1.Validity=true
```

**Explanation:**

The 'Validity' property is true, valid EDID is stored in D1 memory place.

### 6.10.3. Querying the Preferred Resolution of a User EDID

**Command format:** GET●/EDID/U/U<sub>n</sub>.PreferredResolution

**Response format:** pr●/EDID/U/U<sub>n</sub>.PreferredResolution=<preferred\_resolution>

**Example:**

```
> GET /EDID/U/U1.PreferredResolution
< pr /EDID/U/U1.PreferredResolution=3840x2160p60.00Hz
```

INFO: Use the "Manufacturer" property to query the manufacturer and the "MonitorName" property to query the name of the monitor.

### 6.10.4. Emulating an EDID to an Input Port

**Command format:** CALL●/EDID:switch(<source>:<destination>)

**Response format:** mO●/EDID:switch

**Example:**

```
> CALL /EDID:switch(F144:E2)
< mO /EDID:switch
```

**Legend:**

- <source>: Source EDID memory place: Factory / User / Dynamic.
- <destination>: The emulated EDID memory of the desired input port.

### 6.10.5. Copying an EDID to User Memory

**Command format:** CALL●/EDID:copy(<D<sub>n</sub>>|<E<sub>n</sub>>|<F<sub>n</sub>>|<U<sub>n</sub>>:<U<sub>m</sub>>)

**Response format:** mO●/EDID:copy

**Example:**

```
> CALL /EDID:copy(D1:U1)
< mO /EDID:copy
```

**Explanation:**

The EDID of the last connected sink of D1 (Output 1) has been copied to U2.

### 6.10.6. Deleting an EDID from User Memory

**Command format:** CALL●/EDID:delete(<U<sub>n</sub>>)

**Response format:** mO●/EDID:delete

**Example:**

```
> CALL /EDID:delete(U1)
< mO /EDID:delete
```

### 6.10.7. Resetting the Emulated EDIDs

**Command format:** CALL●/EDID:reset(1)

**Response format:** mO●/EDID:reset

**Example:**

```
> CALL /EDID:reset(1)
< mO /EDID:reset
```

**Explanation:** Calling this method switches all emulated EDIDs to factory default one. See the table in the [Factory EDID List](#) section.

## 6.11. LW3 Commands - Quick Summary

### System Commands

Operation / Path	
6.5.1	Querying the Product Name /MANAGEMENT/UID/ProductName
6.5.2	Setting the Device Label /MANAGEMENT/UID/DeviceLabel
6.5.3	Querying the Serial Number /MANAGEMENT/UID/SerialNumber
6.5.4	Querying the Firmware Version /SYS/MB.FirmwareVersion
6.5.5	Resetting the Extender /SYS:reset()
6.5.6	Restoring the Factory Default Settings /SYS:factoryDefaults()
6.5.7	Locking Front Panel /MANAGEMENT/UI_ControlLock
6.5.8	Enabling Dark Mode SET /MANAGEMENT/UI/DARKMODE.DarkModeEnable
6.5.9	Setting the Dark Mode Delay /MANAGEMENT/UI/DARKMODE.DarkModeDelay
6.5.10	Setting the Dark Mode on the Remote Device /REMOTE/D1.DarkModeEnable
6.5.11	Setting the Rotary Direction of the Jog Dial Knob /MANAGEMENT/UI.RotaryDirection

### Video Port and Crosspoint Settings

Operation / Path	
6.6.1	Querying the Crosspoint Setting /MEDIA/VIDEO/XP.DestinationConnectionList
6.6.2	Switching Video Input /MEDIA/VIDEO/XP:switch(<input>:<output>)
6.6.3	Querying the Status of Source Ports /MEDIA/VIDEO/XP.SourcePortStatus
6.6.4	Querying the Status of Destination Ports /MEDIA/VIDEO/XP.DestinationPortStatus
6.6.5	Muting Input Port /MEDIA/VIDEO/XP:muteSource(<input>)
6.6.6	Unmuting Input Port /MEDIA/VIDEO/XP:unmuteSource(<input>)

Operation / Path	
6.6.7	Locking Input Port /MEDIA/VIDEO/XP:lockSource(<input>)
6.6.8	Unlocking Input Port /MEDIA/VIDEO/XP:unlockSource(<input>)
6.6.9	Querying the Video Autoselect Settings /MEDIA/VIDEO/XP.DestinationPortAutoselect
6.6.10	Changing the Autoselect Mode /MEDIA/VIDEO/XP:setDestinationPortAutoselectoutput(<output>:<output_set>)
6.6.12	Setting the Output Conversion Mode /MEDIA/VIDEO/<output>.Conversion
6.6.13	Setting the Output Conversion Mode of the Remote Device /REMOTE/<output>.Conversion

### Network Configuration

Operation / Path	
6.7.1	Querying the IP Address /MANAGEMENT/NETWORK.IpAddress
6.7.2	Changing the IP Address (Static) /MANAGEMENT/NETWORK.StaticIpAddress
6.7.3	Querying the Subnet Mask /MANAGEMENT/NETWORK.NetworkMask
6.7.4	Changing the Subnet Mask (Static) /MANAGEMENT/NETWORK.StaticNetworkMask
6.7.5	Querying the Gateway Address /MANAGEMENT/NETWORK.GatewayAddress
6.7.6	Changing the Gateway Address (Static) /MANAGEMENT/NETWORK.StaticGatewayAddress
6.7.7	Querying the DHCP State /MANAGEMENT/NETWORK.DhcpEnabled
6.7.8	Changing the DHCP State /MANAGEMENT/NETWORK.DhcpEnabled
6.7.9	Enabling Ethernet Port /MEDIA/ETHERNET/<port_no>.Enabled

**RS-232 Port Configuration**

Operation / Path	
6.8.1	Querying the RS-232 Operation Mode /MEDIA/UART/P1.Rs232Mode
6.8.2	Setting the RS-232 Operation Mode /MEDIA/UART/P1.Rs232Mode
6.8.3	Setting the BAUD Rate /MEDIA/UART/P1.Baudrate
6.8.4	Setting the Databit /MANAGEMENT/NETWORK.StaticNetworkMask
6.8.5	Setting the Stopbits /MEDIA/UART/P1.StopBits
6.8.6	Setting the Parity /MEDIA/UART/P1.Parity
6.8.7	Enabling Command Injection Mode /MEDIA/UART/P1.CommandInjectionEnable

**Sending Message via the Communication Ports**

Operation / Path	
6.9.1	Sending Message via an RS-232 Port /MEDIA/UART/P1.sendMessage(<message>) /MEDIA/UART/P1.sendText(<text>) /MEDIA/UART/P1.sendBinaryMessage(<binarymessage>)
6.9.2	Sending Message via TCP Port /MEDIA/ETHERNET:tcpMessage(<IP_address>:<port_no>=<message>) /MEDIA/ETHERNET:tcpText(<IP_address>:<port_no>=<message>) /MEDIA/ETHERNET:tcpBinary(<IP_address>:<port_no>=<message>)
6.9.3	Sending Message via UDP Port /MEDIA/ETHERNET:udpMessage(<IP_address>:<port_no>=<message>) /MEDIA/ETHERNET:udpText(<IP_address>:<port_no>=<message>) /MEDIA/ETHERNET:udpBinary(<IP_address>:<port_no>=<message>)

**EDID Management**

Operation / Path	
6.10.1	Querying the Emulated EDIDs /EDID.EdidStatus
6.10.2	Querying the Validity of a Dynamic EDID /EDID/D/D1.Validity
6.10.3	Querying the Preferred Resolution of a User EDID /EDID/U/U1.PreferredResolution
6.10.4	Emulating an EDID to an Input Port /EDID:switch(<source>:<destination>)
6.10.5	Copying an EDID to User Memory /EDID:copy(<source>:<destination>)
6.10.6	Deleting an EDID from User Memory /EDID:delete(<user_edid_memory>)
6.10.7	Resetting the Emulated EDIDs /EDID:reset(1)



# 7

## Firmware Upgrade

This chapter is meant to help customers perform firmware upgrades on our products by giving a few tips on how to start and by explaining the features of the Lightware Device Updater (LDU) software. To get the latest software and firmware pack can be downloaded from [www.lightware.com](http://www.lightware.com).

- ▶ [ABOUT THE FIRMWARE PACKAGE \(LFP FILE\)](#)
- ▶ [SHORT INSTRUCTIONS](#)
- ▶ [INSTALL AND UPGRADE](#)
- ▶ [DETAILED INSTRUCTIONS](#)
- ▶ [KEEPING THE CONFIGURATION SETTINGS](#)

**ATTENTION!** While the firmware is being upgraded, the normal operation mode is suspended as the extender is switched to bootload mode. Signal processing is not performed. Do not interrupt the firmware upgrade. If any problem occurs, reboot the device and restart the process.

**ATTENTION!** The firmware upgrade process has an effect on the configuration and the settings of the device. For more details, please see the [Keeping the Configuration Settings](#) section before the upgrade.

### 7.1. About the Firmware Package (LFP File)

The firmware files are packed in an LFP package. You need only this file to do the upgrade on your device.

INFO: The same LFP file can be used to upgrade both the transmitter and the receiver.

- The package contains all the necessary components, binary, and other files; You do not have to get further files.
- There is a descriptor file in the package that contains each firmware with version number and a list showing the compatible devices. The descriptor is displayed after loaded the LFP file in the LDU.

### 7.2. Short Instructions

**Step 1.** Get the firmware pack and the Lightware Device Updater (LDU) application.

**Step 2.** Install the LDU application.

**Step 3.** Establish the connection between the computer and the device(s) over the Ethernet interface.

**Step 4.** Start the LDU and follow the instructions shown on the screen.

### 7.3. Install and Upgrade

#### Installation for Windows OS

INFO: The application can be installed under Windows XP or above.

Run the installer. If the User Account Control drops a pop-up message click **Yes**. During the installation you will be prompted to select the type of the installation

Normal install	Snapshot install
Available for Windows and Mac OS X	Available for Windows
The installer can update only this instance	Cannot be updated
Only one updateable instance can exist for all users	More than one different version can be installed for all users

#### Comparison of install types

**ATTENTION!** Using the Normal install as the default value is highly recommended.

#### Installation for Mac OS X

INFO: After the installation the Windows and the Mac application has the same look and functionality. This type of the installer is equal with the Normal install in case of Windows and results an updateable version with the same attributes.

Mount the DMG file with double clicking on it and drag the LDU icon over the Applications icon to copy the program into the Applications folder. If you want to copy the LDU into another location just drag the icon over the desired folder.

#### LDU Upgrade

**Step 1.** Run the application. In the welcome screen click on the  button in the top right corner; the About window will appear. Click on the **Check now** button. The program checks the available updates on Lightware website and shows its version.

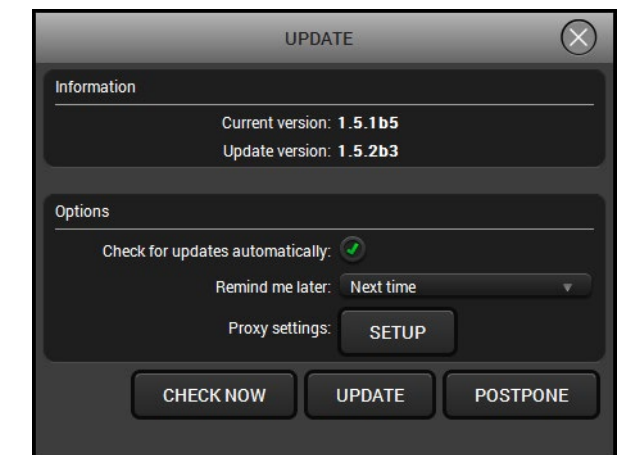

**Step 2.** Set the desired update settings in the **Options** section.

- If you do not want to check for the updates automatically, uncheck the **circle**, which contains the green tick.
- If you want to postpone the update, a reminder can be set with different delays from the **drop down list**.
- If the proxy settings traverse the update process, set the proper values then click the **OK** button.

**Step 3.** Press the **Update** button to download the new version; the installer will start.

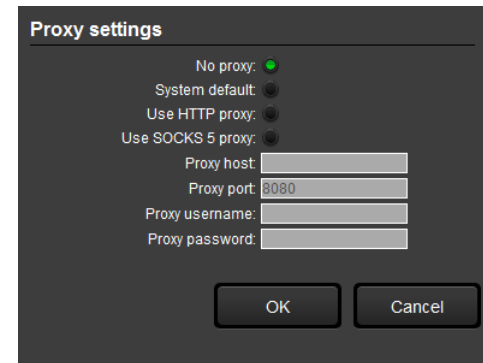

## 7.4. Detailed Instructions

### 7.4.1. Establish the Connection

Make sure that the computer and the device are connected via an Ethernet cable and the connection is established between them.

### 7.4.2. Start the LDU and Follow the Instructions

After launching LDU the welcome screen will appear

Pressing the **i** button a list will appear showing the supported devices:

Click on the **Extender** button on the main screen.

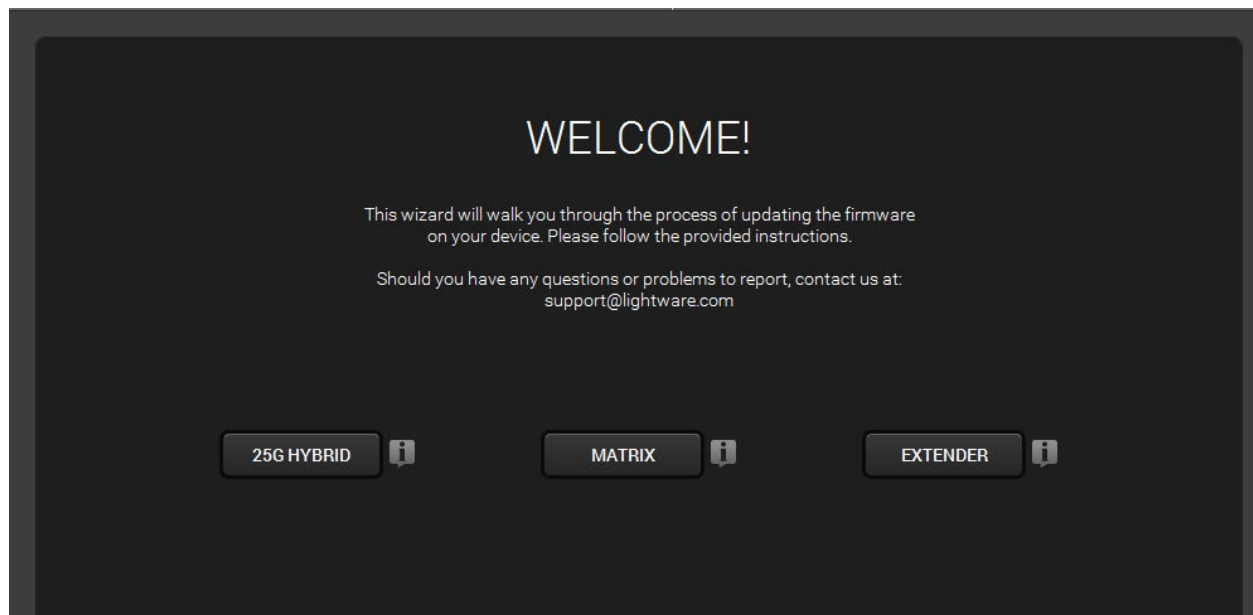

**Step 1. Select the package.**

Click on the Browse button and select the ".lfp" file that will be used for the upgrade.

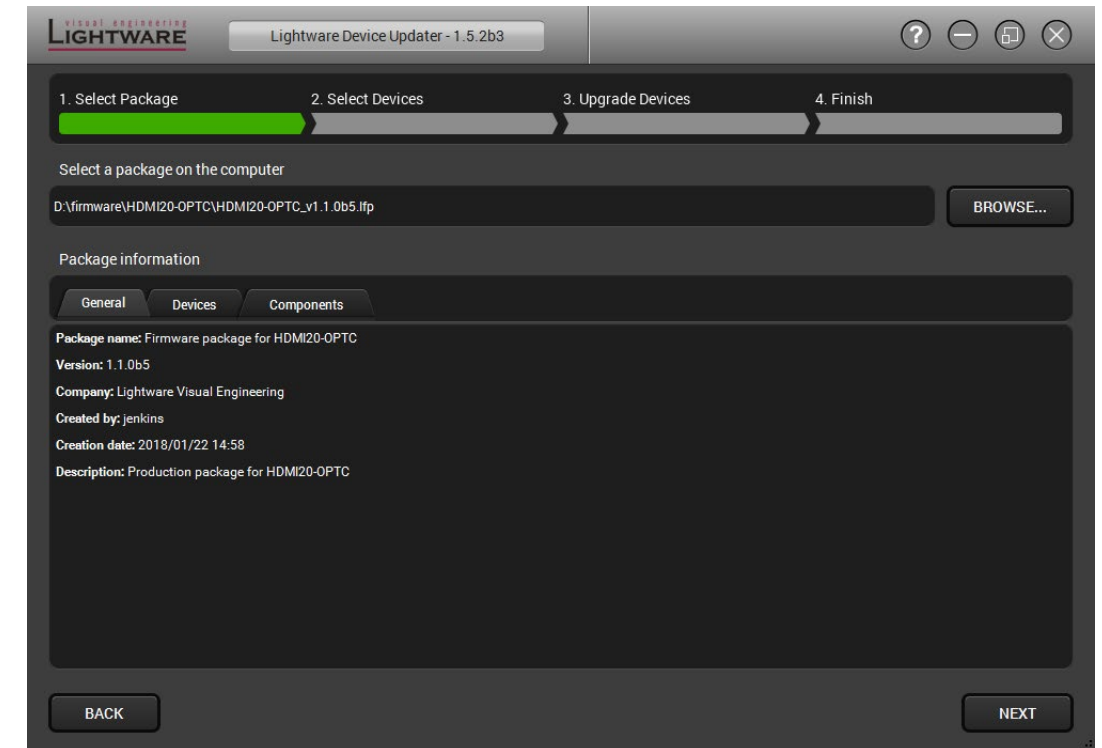

Package information is displayed:

- **General** version info, creation date, short description,
- **Devices** which are compatible with the firmware,
- **Components** in the package with release notes.

Click on the **Next** button and follow the instructions.

**TIPS AND TRICKS:** Files with ".lfp" extension are associated to LDU during installation. If you double click on the ".lfp" file, the application is launched, the package is loaded automatically and the above screen is shown.

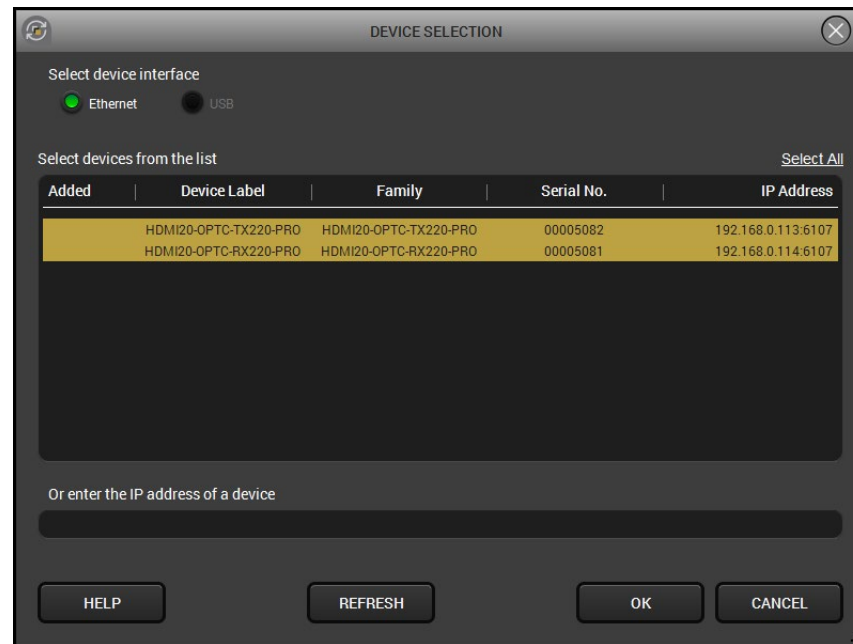
**Step 2. Select device.**

The following step is to select the desired device(s). The available and supported devices are searched and listed automatically. If the desired device is not listed, update the list by clicking the **Refresh** button. Select the desired devices: highlight them with a **yellow cursor**, then click **OK**.

A tick mark can be seen in the **Added** column if the device was added by the user previously.

**Firmware Components**

The firmware components of the selected devices are listed on the following screen: installed and update versions. (Update version will be uploaded to the device.)

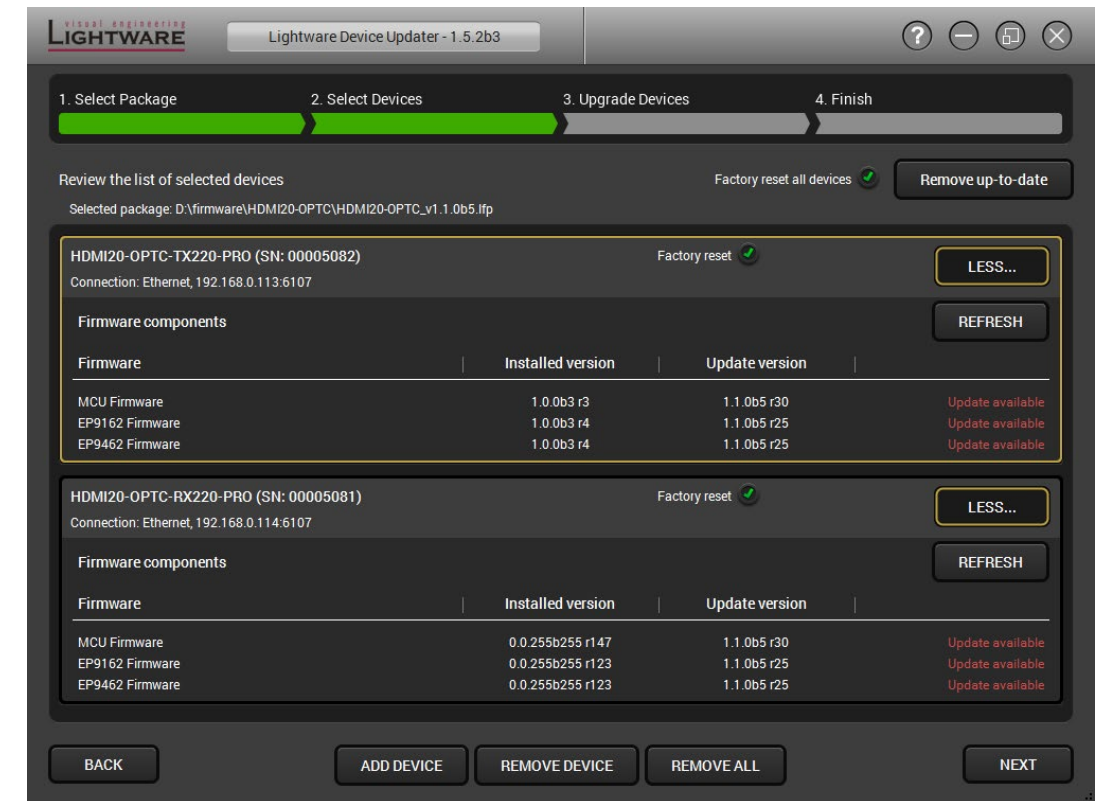

Add a device by clicking on the **Add device** button. The previous screen will be shown; select the desired device(s) and click on **OK**.

Remove a device by selecting it (highlight with yellow) and click on **Remove device** button, or click on **Remove all** button to empty the list.

Enabling **Factory reset** will perform factory default values for all settings in the device. Three different status can exist:

- **Enabled by user:** all settings will set to factory default values.
- **Disabled by user:** your settings will be saved and restored after upgrading.
- **Enabled by default and not changeable by user:** firmware upgrade must perform a factory reset to apply all changes coming with the new firmware version.

Click on the **Next** button to continue.

**Step 3. Upgrade the device.**

Click on the **Start** button to continue.

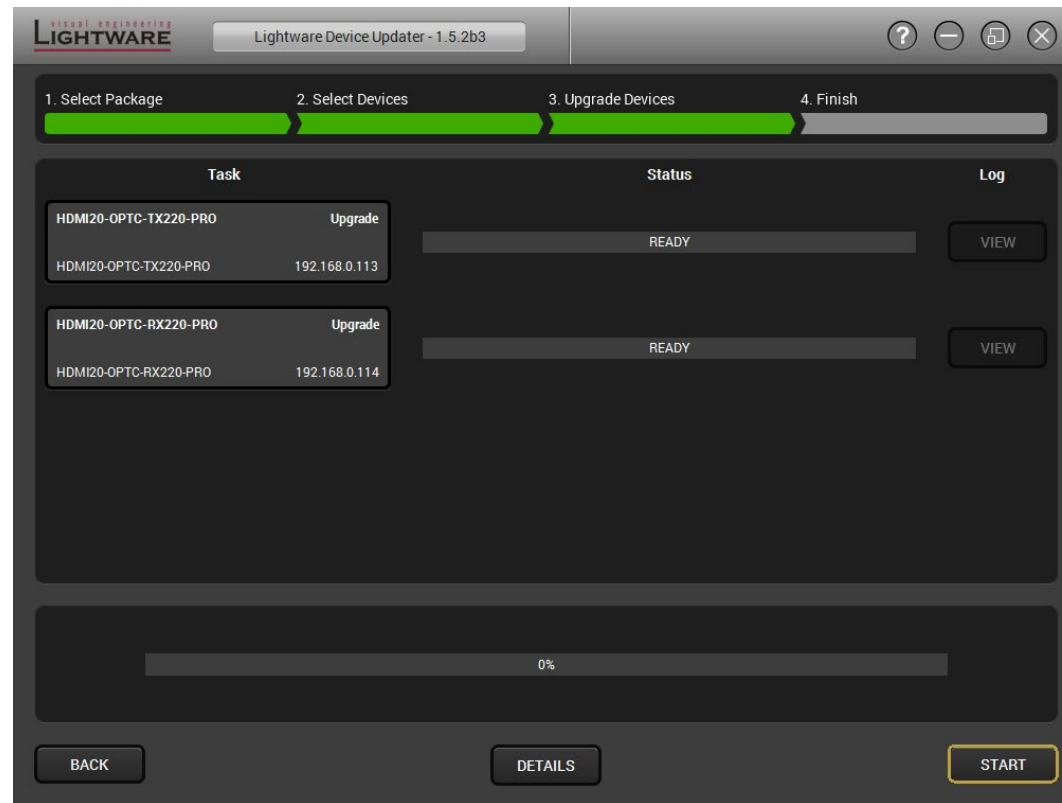

After you confirmed the warnings and clicked on the **Start** button, the upgrade process starts immediately.

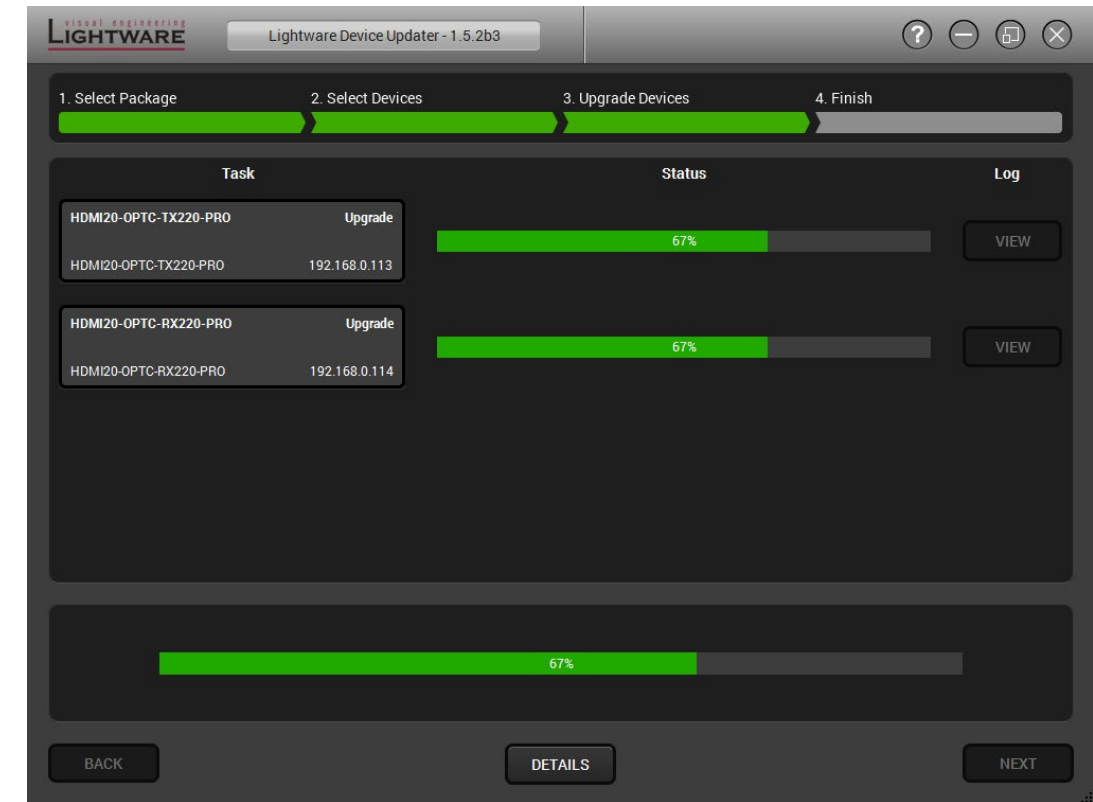

**Details** button opens a new window where the process is logged – see below.

A warning window will pop up before starting upgrading the device:

- Do not unplug the power cable and the LAN cable while the upgrade is in progress. Click **OK** to continue.

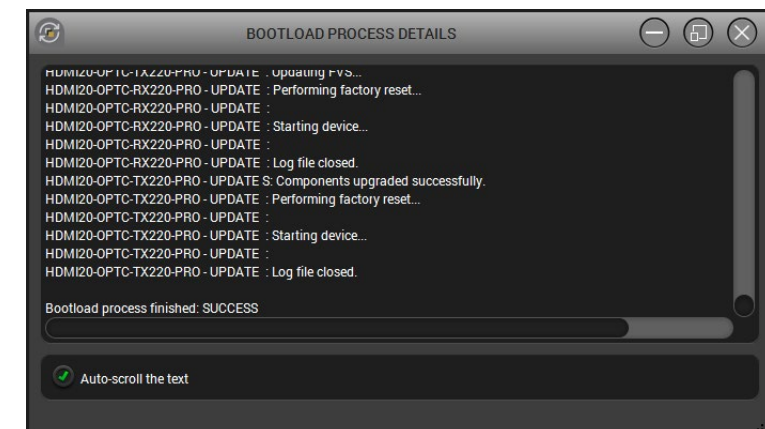
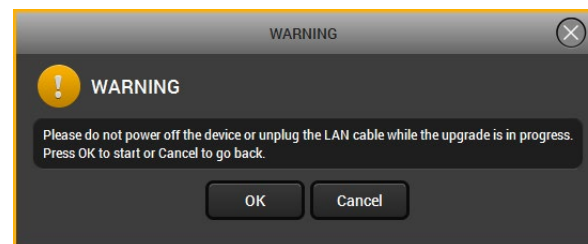

**Step 4. Finish.**

If the upload of the firmware package is finished, LDU gives a message in a pop up-window:

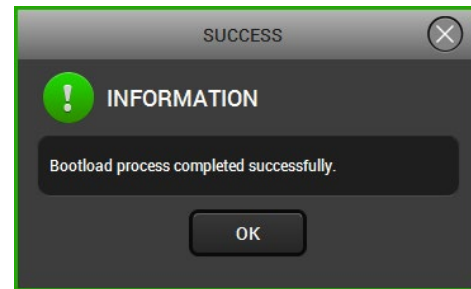

After that, the extender starts the self-upgrade procedure.

**ATTENTION!** Do not disconnect the power supply or the Ethernet cable! It is an automatic action and no user interruption is needed during the operation. The red LEDs show the status of the process. When none of the LEDs light red, the upgrade is finished.

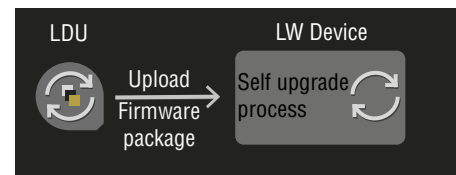

On the summary page logs can be opened by **Open Logs** button or exported with **Export Logs** button. Click **Exit** to close or **Repeat** to begin the upgrade process again.

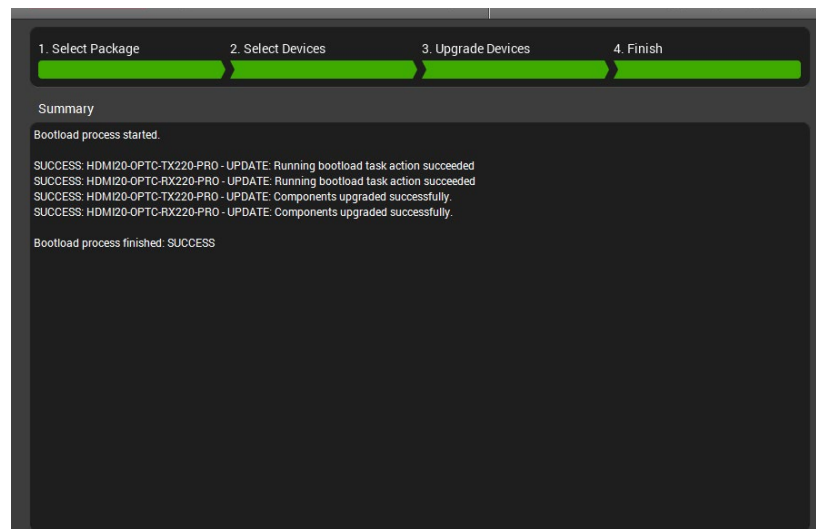

**ATTENTION!** However the device is rebooted after the firmware upgrade, switching it off and on again is recommended.

**7.5. Keeping the Configuration Settings**

User can keep all configuration settings and restore to the device after firmware upgrading or can choose to perform a factory reset – it means all settings will be erased in the device. In case of factory reset you can save the settings of the device and restore it later. For the detailed information about saved data refer to the [Content of Backup File](#) section.

The following flow chart demonstrates how this function works in the background.



**Flow chart of firmware upgrade**

The details about the procedure: when firmware upgrade starts, the first step is making a backup of the settings of the device. The firmware package checks the backup data and if it is needed, a conversion is applied to avoid incompatibility problems between the firmware versions. If you do not want to keep configuration settings, you can set the **Factory reset** option enabled.

The instruction in the firmware package of the device will inform you about this function availability, reading it is highly recommended in every case.

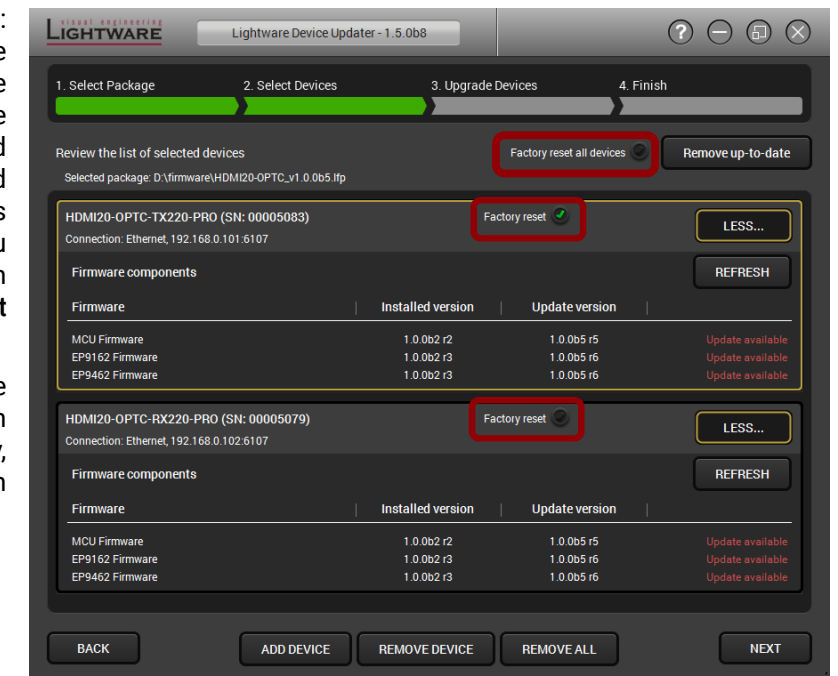

**Select devices page in the firmware package**

**ATTENTION!** In specific cases restoring cannot be applied fully and certain settings are not copied back to the device. If a warning message appears, user can get back the original data from the backup. Logs of the upgrade procedure contain all backup data, it can be exported at the end of the upgrade procedure. Details about the procedure of log exporting can be found in the [Detailed Instructions](#) section. In case of any question, please contact [support@lightware.com](mailto:support@lightware.com).





**ATTENTION!** In certain cases, the new firmware version requires setting all parameters to set factory defaults. In this case, the “Factory reset” option is enabled by default and not changeable by the user, see details in the [Detailed Instructions](#) section.

**ATTENTION!** The feature is only supported by LDU version 1.3.0 and above.











# 8

















## Troubleshooting

Usually, if the system seems not to transport the signal as expected, the best strategy for troubleshooting is to check signal integrity through the whole signal chain starting from source side and moving forward to receiver end.

-  Link to connections/cabling section.
-  Link to front panel operation section.
-  Link to LDC software section.
-  Link to LW3 protocol commands section

At first, check front panel LEDs and take the necessary steps according to their states. For more information about status, LEDs refer to the [Front View](#) and [Rear View](#) sections.

Symptom	Root cause	Action	Refer to
<b>Video signal</b>			
<b>No picture on the video output</b>	Device(s) not powered properly.	Check the extenders and the other devices if they are properly powered; try to unplug and reconnect them.	 <a href="#">3.3</a>
	Cable connection problem.	Due to the high data rates cables must fit very well, check all the connectors. If your source or display has more connectors then make sure that the proper port is selected.	 <a href="#">3.3</a>
	Cable quality problem.	Due to the high data rates, high quality cables must be used. It is recommended to use OM3 or OM4 fiber cables.	 <a href="#">10.4</a>
	Endface surface of the fiber optical cable became contaminated.	Use special fiber optical cable cleaning equipment to clean it carefully.	
	Display is not capable of receiving the sent video format.	Try emulating your display device's EDID to the source.	 <a href="#">4.3.3</a>  <a href="#">5.5</a>  <a href="#">6.10.4</a>
	Source power and configuration problems.	Check whether your source is powered on and configured properly. The HDMI output can be turned off on most DVD players. If the source is a computer, then verify that the HDMI output is selected and active. Try restarting your computer; if you get a picture during the booting process, you have to review the driver settings.	
<b>HDMI output signal contains no audio</b>	Video signal type was set to DVI.	Check the signal type properties of the output port and set to HDMI or Auto.	 <a href="#">5.4.2</a>  <a href="#">5.4.4</a>
	DVI EDID is emulated.	Check the EDID and select and HDMI EDID to emulate.	 <a href="#">4.3.3</a>  <a href="#">5.5</a>  <a href="#">6.10.1</a>

Symptom	Root cause	Action	Refer to
<b>RS-232 signal</b>			
<b>Connected serial device cannot be controlled</b>	Cable connection problem	Check whether your serial cable is properly connected and check the wiring of the plugs.	 3.3
	RS-232 mode is not right	Check the RS-232 mode settings (pass, control and command injection)	 4.3.1  5.6.1  6.8.1
<b>Network</b>			
<b>No LAN connection can be established</b>	Incorrect IP address is set (fix IP)	Use dynamic IP address by enabling DHCP option.	 4.3.1  5.8.2  6.7.8
		Restore the factory default settings (with fix IP).	 4.3.1  5.6.1  6.5.6
	IP address conflict	Check the IP address of the other devices, too.	 5.2
<b>Miscellaneous</b>			
<b>No LEDs are light</b>	Dark mode is enabled	Disable the dark mode	 4.3.1  4.3.5  5.8.3  6.6.12
<b>Select/function button not toggles the inputs/conversion modes</b>	Front panel buttons are locked	Unlock the buttons.	 5.8.3  6.5.7

### How to Speed up the Troubleshooting Process?

Lightware's technical support team is always working hard to provide the fastest support possible. Our team's response time is one of the best in the industry and in the toughest of cases we can directly consult with the hardware or software engineer who designed the product to get the information from the most reliable source.

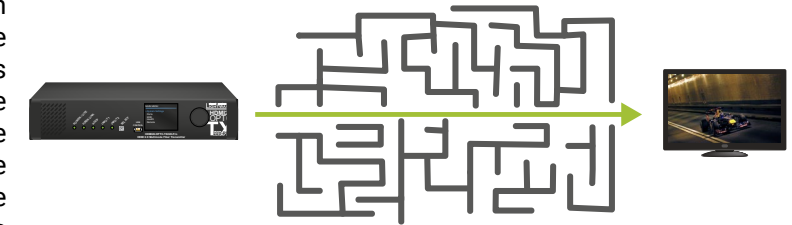

However, the troubleshooting process can be even faster... with your help.

There are certain pieces of information that push us in the right direction to finding the root cause of the problem. If we receive most of this information in the first e-mail or it is gathered at the time when you call us, then there is a pretty high chance that we will be able to respond with the final solution right away.

#### This information is the following:

- Schematic (a pdf version is preferred, but a hand drawing is sufficient).
- Serial number(s) of the device(s) (it is either printed somewhere on the box or you can query it in the Device Controller software or on the built-in website).
- Firmware versions of the devices (please note that there may be multiple CPUs or controllers in the device and we need to know all of their firmware versions, a screenshot is the best option).
- Cable lengths and types (in our experience, it's usually the cable).
- Patch panels, gender changers or anything else in the signal path that can affect the transmission.
- Signal type (resolution, refresh rate, color space, deep color).
- Emulated EDID(s) (please save them as file and send them to us).
- Actions to take in order to re-create the problem (if we cannot reproduce the problem, it is hard for us to find the cause).
- Photo or video about the problem ('image noise' can mean many different things, it's better if we see it too).
- Error logs and backup files from the Lightware Device Controller software.

The more of the above information you can give us the better. Please send these information to the Lightware [Support Team](#) to speed up the troubleshooting process.

# 9

## Technologies

The following sections contain descriptions and useful technical information how the devices work in the background. The content is based on experiences and cases we met in the practice. These sections help to understand features and technical standards like the followings:

- ▶ EDID MANAGEMENT
- ▶ HDCP MANAGEMENT
- ▶ PIXEL ACCURATE RECLOCKING
- ▶ SERIAL MANAGEMENT

### 9.1. EDID Management

#### 9.1.1. Understanding the EDID

The Extended Display Identification Data (EDID) is the passport of display devices (monitors, TV sets, projectors). It contains information about the capabilities of the display, such as supported resolutions, refresh rates (these are called Detailed Timings), the type and manufacturer of the display device, etc.

After connecting a source to a display (DVI, HDMI, DP), the source reads out the EDID to determine the resolution and refresh rate of the image to be transmitted.

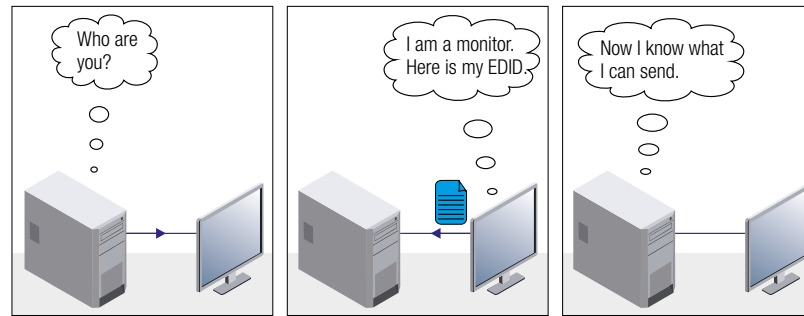

EDID Communication

Most DVI computer displays have 128-byte long EDID structure. However, Digital Televisions and HDMI capable displays may have another 128 bytes, which is called E-EDID and defined by CEA (Consumer Electronics Association). This extension contains information about additional Detailed Timings, audio capabilities, speaker allocation and HDMI capabilities. It is important to know that all HDMI capable devices must have CEA extension, but not all devices with CEA extension are HDMI capable.

#### Common Problems Related to EDID

**Problem:** “My system consists of the following: a computer, a Lightware device, a WUXGA (1920x1200) LCD monitor, and an SXGA (1280x1024) projector. I would like to see the same image on the monitor and the projector. What EDID should I choose on the Lightware device?”

**Solution:** If you want to see the image on both displays, you need to select the resolution of the smaller display (in this case SXGA), otherwise the smaller display may not show the higher resolution image.

**Problem:** “I have changed to a different EDID on an input port of the Lightware device to have a different resolution but nothing happens.”

**Solution:** Some graphics cards and video sources read out the EDID only after power-up and later they do not sense that EDID has been changed. You need to restart your source to make it read out the EDID again.

#### 9.1.2. Advanced EDID Management

Each DVI sink (e.g. monitors, projectors, plasma displays, etc...) must support the EDID data structure. Source BIOS and operating systems are likely to query the sink using DDC2B protocol to determine what pixel formats and interface are supported. DVI standard uses EDID data structure to identify the monitor type and capabilities. Most DVI sources (VGA cards, set top boxes, etc.) will output DVI signal after accepting the connected sink's EDID information. In the case of EDID readout failure or missing EDID, the source will not output DVI video signal.

Lightware devices provide the Advanced EDID Management function that helps system integration. The built-in EDID Router can store and emulate factory pre-programmed- and User programmable EDIDs. The EDID of the attached monitors or projectors for each output are stored in a non-volatile memory. This way the EDID of a monitor is available when the monitor is unplugged or switched off.

Any EDID can be emulated on any input. An emulated EDID can be copied from the EDID router's memory (static EDID emulation), or from the last attached monitor's memory (dynamic EDID emulation). For example, the Lightware device can be set up to emulate a sink device, which is connected to one of the outputs. In this case, the EDID automatically changes, if the monitor is replaced with another display device (as long as it has a valid EDID).

EDID is independently programmable for all inputs without affecting each other. All inputs have their own EDID circuit.

**INFO:** The user is not required to disconnect the video cable to change an EDID as opposed to other manufacturer's products. EDID can be changed even if a source is connected to the input and powered ON.

**INFO:** When EDID has been changed, the router toggles the HOTPLUG signal for 2 seconds. Some sources do not sense this signal. In such cases, the source device must be restarted or powered OFF and ON again.



## 9.2. HDCP Management

Lightware Visual Engineering is a legal HDCP adopter. Several functions have been developed which helps to solve HDCP related problems. Complex AV systems often have both HDCP and non-HDCP components. The extender allows transmitting HDCP encrypted and unencrypted signals. The devices will be still HDCP compliant as they will never output an encrypted signal to a non-HDCP compliant display device. If an encrypted signal is switched to a non-compliant output, a red screen alert or muted screen will appear.

### 9.2.1. Protected and Unprotected Content

Many video sources send HDCP protected signal if they detect that the sink is HDCP capable – even if the content is not copyrighted. This can cause trouble if an HDCP capable device is connected between the source and the display. In this case, the content cannot be viewed on non-HDCP capable displays and interfaces like event controllers. Rental and staging technicians often complain about certain laptops, which are always sending HDCP encrypted signals if the receiver device (display, extender router, etc.) reports HDCP compliancy. However, HDCP encryption is not required all the time e.g. computer desktop image, certain laptops still do that.

To avoid unnecessary HDCP encryption, Lightware introduced the HDCP enabling/disabling function: the HDCP capability can be disabled in the Lightware device. If HDCP is disabled, the connected source will detect that the sink is not HDCP capable, and turn off authentication.

### 9.2.2. Disable Unnecessary Encryption

#### HDCP Compliant Sink

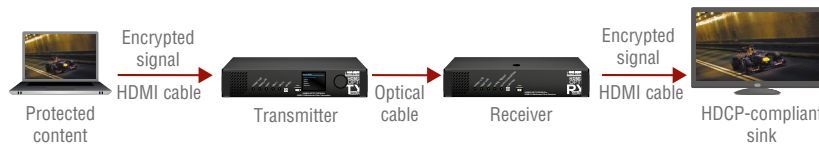

All the devices are HDCP-compliant, no manual setting is required, both protected and unprotected contents are transmitted and displayed on the sink.

#### Not HDCP-compliant Sink 1.

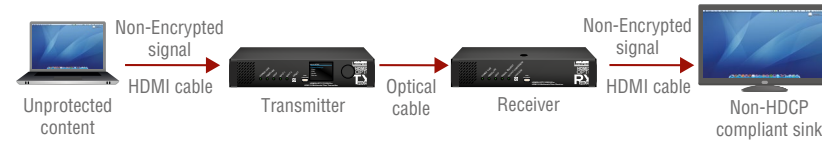

Non-HDCP compliant sink is connected to the extender. Some sources (e.g. computers) always send HDCP encrypted signals if the receiver device reports HDCP compliancy, however, HDCP encryption is not required all the time (e.g. computer desktop image). If HDCP is enabled in the extender, the image will not be displayed on the sink.

Setting the HDCP parameter to Auto on the output port and disable HDCP on the input port, the transmitted signal will not be encrypted if the content is not protected. Thus, non-HDCP compliant sinks will display non-encrypted signal.

#### Not HDCP-compliant Sink 2.

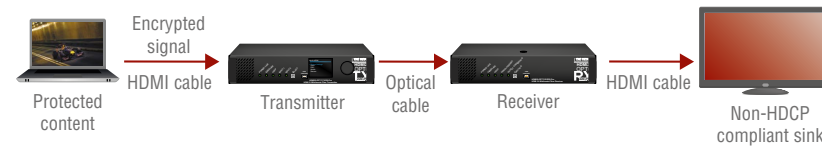

The layout is the same as in the previous case: non-HDCP compliant display device is connected to the extender but the source would send protected content with encryption. If HDCP is enabled on the input port of the extender, the source will send encrypted signal. The sink is not HDCP compliant, thus, it will not display the video signal (but blank/red/muted/etc. screen). If HDCP is disabled on the input port of the extender, the source will not send the signal. The solution is to replace the display device to an HDCP-capable one.

### 9.3. Pixel Accurate Reclocking

Signal reclocking is an essential important procedure in digital signal transmission. After passing the reclocking circuit, the signal becomes stable, jitter-free, and can be transmitted over more equipment like processors, or event controllers. Without reclocking, sparkles, noise, and jaggies appear on the image.

Lightware's sophisticated Pixel Accurate Reclocking technology fixes more problems than general TMDS reclocking. It removes not only intra-pair skew but inter-pair skew as well. The Pixel Accurate Reclocking circuit eliminates the following errors:

#### Intra-pair skew

Skew between the + and - wires within a differential wire pair (e.g. Data2- and Data2+). It's caused by different wire lengths or slightly different wire construction (impedance mismatch) in DVI cable. It results in jitter.

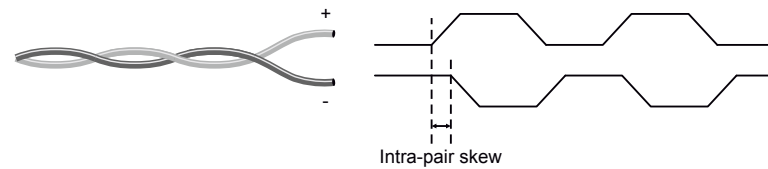

#### Inter-pair skew

Skew between two differential wire pairs in a cable. It is caused by different wire pair lengths or different number of twists in the DVI cable. Too much inter-pair skew results color shift in the picture or sync loss.

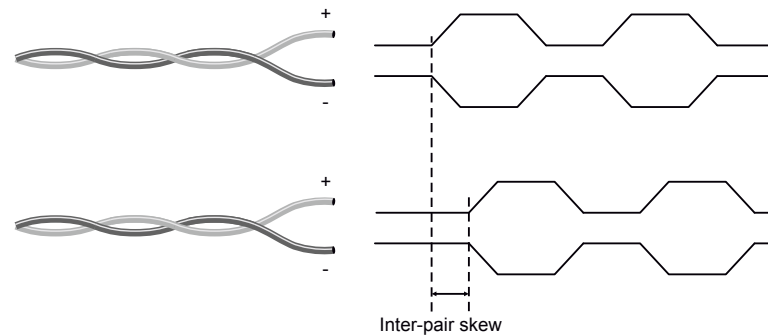

#### Jitter

Signal instability in the time domain. The time difference between two signal transitions should be a fixed value, but noise and other effects cause variations.

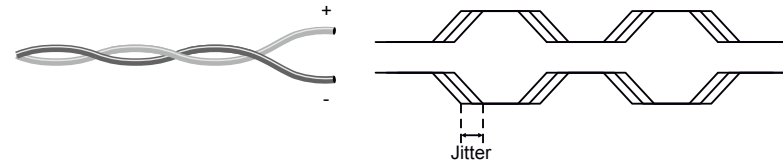

#### Noise

Electromagnetic interference between other electronic devices such as mobile phones, motors, etc. and the DVI cable are coupled onto the signal. Too much noise results in increased jitter.

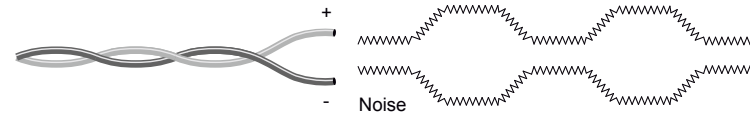

## 9.4. Serial Management

### 9.4.1. General Information

There are two types of devices in general serial communication:

- **Data Terminal Equipment:** Data Terminal Equipment (DTE) is an end instrument that converts user information into signals or reconverts received signals. Typical DTE devices: computers, LCD touch panels and control systems.
- **Data Circuit-terminating Equipment:** Data Circuit-terminating Equipment (DCE) is a device that sits between the DTE and a data transmission circuit. It is also called data communication equipment and data carrier equipment. Typical DCE devices: projectors, industrial monitors and amplifiers.

Among others the pin assignment is different between DTE and DCE.

	DTE	DCE
Pin 2:	RD	TD
Pin 3:	TD	RD



RD: Received Data (digital input)  
TD: Transmitted Data (digital output)

Different type of serial cables must be used between different serial devices.

	DTE	DCE
DTE	Null-modem	Straight
DCE	Straight	Null-modem*

\* In general contact DCE with DCE by tail-circuit serial cable.

### 9.4.2. Types of Serial Cables

Straight Serial Cable	Null-modem Serial Cable
Straight pin-outs both ends.	Straight pin-out at the one end and cross pin-out at the other end (interchange lines of TX and RX).
	

Serial cables between devices may have male or female plugs and their type may be straight or null-modem in usual.

**ATTENTION!** The cable type does not depend on the plug type.

### 9.4.3. RS-232 Signal Transmission over Lightware Extender Devices

The following examples describe the detailed integration of Lightware devices between different RS-232 pin assignment units.

INFO: Both HDMI20-OPTC-TX220-Pro and HDMI20-OPTC-RX220-Pro are DTE units (according to their pinouts) with male plugs.

#### Extending RS-232 between DTE and DCE third-party devices

Connect null-modem serial cable between controller system (DTE) and the transmitter (DTE) and straight serial cable between receiver (DTE) and projector (DCE).

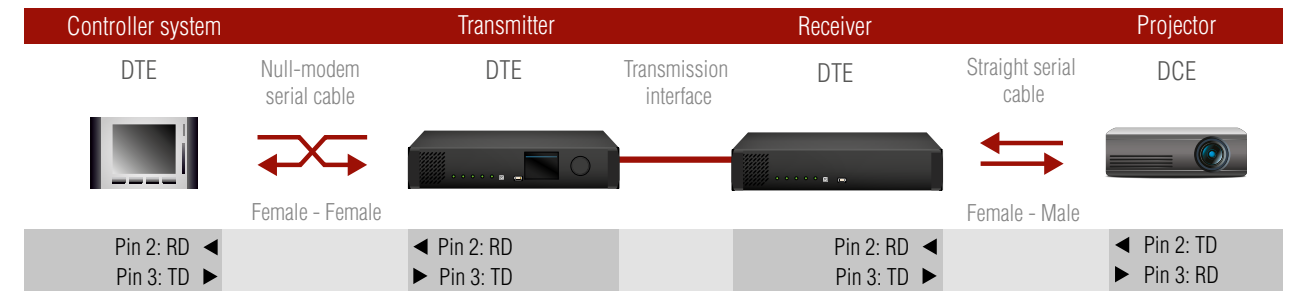

RS-232 connection example between a controller system and a projector

#### Extending RS-232 between DCE and DCE third-party devices

Connect straight serial cable between controller system (DTE) and the transmitter (DCE) and null-modem serial cable between receiver (DTE) and computer (DTE).

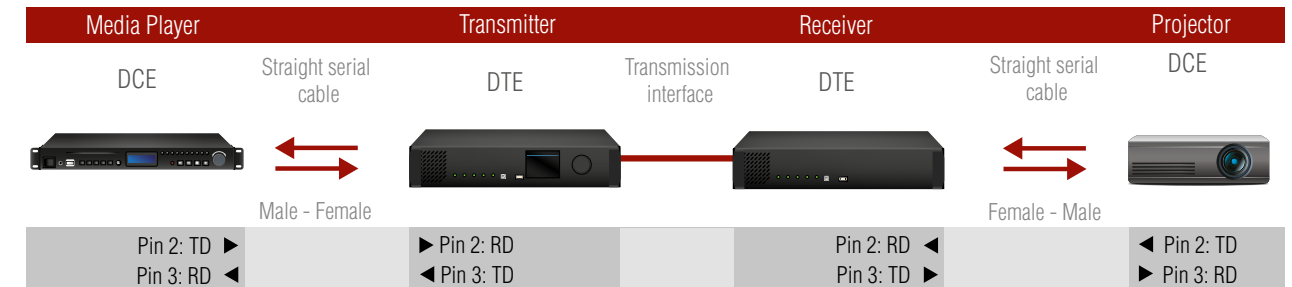

RS-232 connection example between a media player and a projector

# 10

## Appendix

- ▶ SPECIFICATION
- ▶ CONTENT OF BACKUP FILE
- ▶ FACTORY DEFAULT SETTINGS
- ▶ MAXIMUM EXTENSION DISTANCES
- ▶ FACTORY EDID LIST
- ▶ MECHANICAL DRAWINGS
- ▶ FURTHER INFORMATION

### 10.1. Specification

#### General

Compliance .....	CE
EMI/EMC compliance .....	EN 55035:2017, EN 55032:2015
RoHS compliance.....	Yes
Safety.....	EN 60065 Class I
Cooling.....	Cooling fan
Operating temperature .....	0 to +50°C (+32 to +122°F)
Storage temperature.....	-40 to +85°C (-40 to +185°F)
Operating humidity .....	10% to 80%, non-condensing
HDCP compliance.....	Yes
Warranty .....	3 years

#### Power

Power source.....	100-240V AC, 50/60Hz
Power consumption - typical (TX) .....	7,1 W
Power consumption -max (TX) .....	11,6 W
Power consumption - typical (RX) .....	6,5 W
Power consumption -max (RX).....	9,9 W

#### Enclosure

Rack mountable .....	Yes
Material.....	1 mm steel
Dimensions in mm (with device ears) .....	221W x 222,25D x 42,9H
Weight TX/RX.....	1480 g/1475 g

#### Optical Port

Optical connector.....	Neutrik opticalCON DUO LC
Optical break-out connector.....	LC
Fiber .....	50/125 µm Multimode (OM3 or OM4 recommended)
Laser forward wavelengths.....	5ch.: 778; 801; 824; 850; 911 nm
Laser return wavelength.....	980nm
Laser class specification.....	Class 3R
Transmission distance .....	700 meters (using OM4 type fiber)

#### Video Ports

Port connector type.....	19-pole HDMI type A receptacle
Supported video formats .....	DVI 1.0, HDMI 1.4, HDMI 2.0
Max. resolution .....	4096x2160@60Hz
Max. cable length on input (22 AWG).....	30 m
Color depth.....	Deep color support up to 36 bits,
Color space .....	RGB, YCbCr 4:4:4/4:2:0
Data rate TX (I1, I2, O1).....	18 Gbps
Data rate RX (O1A, O2) .....	18 Gbps
Data rate RX (O1B).....	9 Gbps
3D support.....	Yes
Audio formats.....	all formats in line with HDMI 2.0 standard
EDID emulation .....	Yes, Advanced EDID management
Reclocking.....	Pixel Accurate Reclocking

#### Control Ports

##### LAN

LAN connector .....	Neutrik etherCON
Data rate .....	1 Gbit/s

##### RS-232 Control

Serial port connector .....	D-SUB connector
Available Baud rates .....	between 4800 and 115200

##### USB Control

USB connector .....	USB mini B type
USB 2.0 compliance.....	Yes

## 10.2. Content of Backup File

Transmitter	Receiver
<b>HDMI Input (I1, I2)</b>	
Port name	
Mute/ unmute input ports	
Lock/ unlock input ports	
Crosspoint settings	
<b>Optical Output (O1)</b>	<b>Optical Input (I1)</b>
Port name	Port name
Mute/ unmute output port	Mute/ unmute output port
Lock/ unlock output port	Lock/ unlock output port
Autoselect settings	
Signal type	Signal type
<b>HDMI Output (O2)</b>	<b>HDMI Output (O1,O2,O3)</b>
Port name	Port name
Mute/ unmute output port	Mute/ unmute output port
Lock/ unlock output port	Lock/ unlock output port
Autoselect settings	
Signal type	Signal type
+5V Enable	+5V Enable
<b>RS-232</b>	<b>RS-232</b>
Port name	Port name
RS-232 mode	RS-232 mode
Baud rate/ Data bits/ Stop bits/ Parity	Baud rate/ Data bits/ Stop bits/ Parity
Command injection enable/ Port	Command injection enable/ Port
Control protocol	Control protocol
<b>Ethernet</b>	<b>Ethernet</b>
Port name (P1, P2, P3, P4)	Port name (P1, P2, P3, P4)
Enable (P1, P2)	Enable (P1, P2)
<b>EDID Settings</b>	<b>EDID Settings</b>
User EDID U1-14	User EDID U1-13
Emulated EDIDs	Emulated EDIDs
<b>Event Manager</b>	<b>Event Manager</b>
Events 1-20	Events 1-20
<b>Front Panel Control</b>	<b>Front Panel Control</b>
Display brightness	
Rotary direction	
Control lock	
Dark mode enable	Dark mode enable

Transmitter	Receiver
Dark mode delay	Dark mode delay
Device label	Device label
<b>Network</b>	<b>Network</b>
DHCP enable	DHCP enable
Static IP address	Static IP address
Static network mask	Static network mask
Static gateway address	Static gateway address
<b>Remote device (Receiver)</b>	
Conversion mode	
O1 +5V Enable	
O2 +5V Enable	
O3 +5V Enable	

## 10.3. Factory Default Settings

### Factory Default Settings of the HDMI20-OPTC-TX220-Pro

Transmitter	
<b>Video settings: HDMI Input</b>	
Port number	I1, I2
Port name	HDMIIN1, HDMIIN2
Mute/ unmute input ports	Unmuted
Lock/ unlock input ports	Unlocked
Crosspoint settings	I1:O1; I1:O2
<b>Video settings: Optical Output</b>	
Port name	OPTOUT
Port number	O1
Mute/ unmute output port	Unmuted
Lock/ unlock output port	Unlocked
Autoselect settings	Disabled
Signal type	Auto
<b>Video settings: HDMI Output</b>	
Port name	HDMIOUT
Port number	O2
Mute/ unmute output port	Unmuted
Lock/ unlock output port	Unlocked
Autoselect settings	Disabled
Signal type	Auto
+5V Enable	Always on

Transmitter	
<b>Front panel settings</b>	
Display brightness	10
Rotary direction	CW
Control lock	Unlock
Dark mode enable, dark mode delay	Disable
<b>General</b>	
Device label	HDMI20-OPTC-TX220-PRO
<b>Network</b>	
DHCP enable	Disabled
Static IP address	192.168.0.101
Static network mask	255.255.255.0
Static gateway address	192.168.0.1
<b>Remote device (Receiver)</b>	
Conversion mode	No conversion
O1 +5V Enable (Output 1/A)	Always on
O2 +5V Enable (Output 1/B)	Always on
O3 +5V Enable (Output 2)	Always on

## Factory Default Settings of the HDMI20-OPTC-RX220-Pro

Receiver	
<b>Video settings: Optical Input</b>	
Port name	OPTIN
Port number	I1
Mute/ unmute input ports	Unmute
Lock/ unlock input ports	Unlock
<b>Video settings: HDMI Output</b>	
Port name	HDMIOUT1A, HDMIOUT1B, HDMIOUT2
Port number	O1, O2, O3
Mute/ unmute output port	Unmuted
Lock/ unlock output port	Unlocked
Signal type	Auto
+5V Enable	Always on
Conversion mode*	No conversion
<b>Front panel</b>	
Control lock	Unlock
Dark mode enable, dark mode delay	Disable
<b>General</b>	
Device label	HDMI20-OPTC-RX220-PRO
<b>Network</b>	
DHCP enable	Disabled
Static IP address	192.168.0.102
Static network mask	255.255.255.0
Static gateway address	192.168.0.1

\* This setting is only available at HDMIOUT1A (O1) port.

## Factory Default Settings of the HDMI20-OPTC-TX220-Pro and HDMI20-OPTC-TX220-Pro

Transmitter	Receiver
<b>RS-232</b>	
Port name	Local
RS-232 mode	Pass-through
Baud rate	57600
Data bits	8
Stop bits	N
Parity	1
Command injection enable	Disabled
Port	8001
Control protocol	LW2
<b>Ethernet</b>	
Port name (P1, P2, P3, P4)	Ethernet, Ethernet, OPT, CPU
Enable (P1, P2)	Enable
<b>EDID Settings</b>	
Emulated EDIDs	D1* for all inputs
<b>Front panel</b>	
Display brightness	10
Rotary direction	CW
Control lock	Unlock
Dark mode enable, dark mode delay	Disable
<b>Remote device (Receiver)</b>	
Conversion mode	No conversion
O1 +5V Enable (Output 1/A)	Always on
O2 +5V Enable (Output 1/B)	Always on
O3 +5V Enable (Output 2)	Always on

\*The default emulated EDID is D1 both the transmitter and the receiver. The EDID, which is from the attached monitor of HDMIOUT1A (O1) port of the receiver, is copied to all the input ports.

## 10.4. Maximum Extension Distances

The below table shows the transmission distances via optical cable between the HDMI20-OPTC-TX220-Pro HDMI20-OPTC-RX220-Pro depending on the cable quality and pixel clock frequency.

Resolution, Pixel clock rate	Cable lengths			
	OM1	OM2	OM3	OM4
1280x720p60 Hz	800m	1000m	2500m	2500m
1920x1080p60 Hz	500m	1000m	2500m	2500m
3840x2160p30 Hz (4k30 4:4:4)	200m	600m	1500m	1500m
3840x2160p60 Hz (4k60 4:2:0)				
3840x2160p60 Hz (4k60 4:4:4)	<b>Not supported</b>	300m	700m	700m
4096x2160p60 Hz (DCI 4K60)				

## 10.5. Factory EDID List

Mem.	Resolution	Type
F1	640 x 480 @ 60.00 Hz	DVI
F2	848 x 480 @ 60.00 Hz	DVI
F3	800 x 600 @ 60.32 Hz	DVI
F4	1024 x 768 @ 60.00 Hz	DVI
F5	1280 x 768 @ 50.00 Hz	DVI
F6	1280 x 768 @ 59.94 Hz	DVI
F7	1360 x 768 @ 75.00 Hz	DVI
F8	1360 x 768 @ 60.02 Hz	DVI
F9	1280 x 1024 @ 50.00 Hz	DVI
F10	1280 x 1024 @ 60.02 Hz	DVI
F11	1280 x 1024 @ 75.02 Hz	DVI
F12	1400 x 1050 @ 50.00 Hz	DVI
F13	1400 x 1050 @ 60.00 Hz	DVI
F14	1400 x 1050 @ 75.00 Hz	DVI
F15	1680 x 1050 @ 60.00 Hz	DVI
F16	1920 x 1080 @ 50.00 Hz	DVI
F17	1920 x 1080 @ 60.00 Hz	DVI
F18	2048 x 1080 @ 50.00 Hz	DVI
F19	2048 x 1080 @ 60.00 Hz	DVI
F20	1600 x 1200 @ 50.00 Hz	DVI
F21	1600 x 1200 @ 60.00 Hz	DVI
F22	1920 x 1200 @ 50.00 Hz	DVI
F23	1920 x 1200 @ 59.56 Hz	DVI
F24	2048 x 1200 @ 59.96 Hz	DVI
F25-F28	Reserved	
F29	Universal DVI EDID	
F30	1440 x 480i @ 60.05 Hz	HDMI
F31	1440 x 576i @ 50.08 Hz	HDMI
F32	640 x 480 @ 59.95 Hz	HDMI
F33	720 x 480 @ 59.94 Hz	HDMI
F34	720 x 576 @ 50.00 Hz	HDMI
F35	1280 x 720 @ 50.00 Hz	HDMI
F36	1280 x 720 @ 60.00 Hz	HDMI
F37	1920 x 1080i @ 50.04 Hz	HDMI

Mem.	Resolution	Type
F38	1920 x 1080i @ 50.00 Hz	HDMI
F39	1920 x 1080i @ 60.05 Hz	HDMI
F40	1920 x 1080i @ 60.05 Hz	HDMI
F41	1920 x 1080 @ 24.00 Hz	HDMI
F42	1920 x 1080 @ 25.00 Hz	HDMI
F43	1920 x 1080 @ 30.00 Hz	HDMI
F44	1920 x 1080 @ 50.00 Hz	HDMI
F45	1920 x 1080 @ 60.00 Hz	HDMI
F46	1920 x 1080 @ 60.00 Hz	HDMI
F47	Universal HDMI EDID; PCM audio	
F48	Universal HDMI EDID; all audio	
F49	Universal HDMI EDID; all audio, deep color	
F50-F89	Reserved	
F90	1920 x 2160 @ 59.99 Hz	DVI
F91	1024 x 2400 @ 60.01 Hz	DVI
F92-F93	Reserved	
F94	2048 x 1536 @ 60.00 Hz	DVI
F95	Reserved	
F96	2560 x 1600 @ 59.86 Hz	DVI
F97	3840 x 2400 @ 24.00 Hz	DVI
F98	1280 x 720 @ 60.00 Hz	HDMI
F99	1920 x 1080 @ 60.00 Hz	HDMI
F100	1024 x 768 @ 60.00 Hz	HDMI
F101	1280 x 1024 @ 50.00 Hz	HDMI
F102	1280 x 1024 @ 60.02 Hz	HDMI
F103	1280 x 1024 @ 75.02 Hz	HDMI
F104	1600 x 1200 @ 50.00 Hz	HDMI
F105	1600 x 1200 @ 60.00 Hz	HDMI
F106	1920 x 1200 @ 59.56 Hz	HDMI
F107	2560 x 1440 @ 59.95 Hz	HDMI
F108	2560 x 1600 @ 59.86 Hz	HDMI
F109	3840 x 2400 @ 24.00 Hz	HDMI
F110	3840 x 2160 @ 24.00 Hz	HDMI
F111	3840 x 2160 @ 25.00 Hz	HDMI
F112	3840 x 2160 @ 30.00 Hz	HDMI

Mem.	Resolution	Type
F113-F117	Reserved	
F118	Universal HDMI EDID; 4K, PCM audio	
F119	Universal HDMI EDID; 4K, all audio	
F120	3840 x 2160 @ 60.00 Hz	HDMI
F121	1440 x 1080 @ 59.91 Hz	HDMI
F122	2560 x 2048 @ 59.98 Hz	HDMI
F123	1280 x 800 @ 59.91 Hz	HDMI
F124	1440 x 900 @ 59.90 Hz	HDMI
F125	1368 x 768 @ 59.85 Hz	HDMI
F126	1600 x 900 @ 59.98 Hz	HDMI
F127	2048 x 1080 @ 60.00 Hz	HDMI
F128	2560 x 1080 @ 60.00 Hz	HDMI
F129	3440 x 1440 @ 24.99 Hz	HDMI
F130	3440 x 1440 @ 29.99 Hz	HDMI
F131	4096 x 2160 @ 25.00 Hz	HDMI
F132	4096 x 2160 @ 30.00 Hz	HDMI
F133	4096 x 2160 @ 60.00 Hz	HDMI
F134	3440 x 1440 @ 23.99 Hz	HDMI
F135	4096 x 2160 @ 24.00 Hz	HDMI
F136	3840 x 2400 @ 29.99 Hz	HDMI
F137	3840 x 2160 @ 60.00 Hz	HDMI 2.0
F138	3840 x 2160 @ 50.00 Hz	HDMI 2.0
F139	Universal HDMI 2.0 EDID; UHD, PCM audio	
F140	Universal HDMI 2.0 EDID; UHD, all audio	
F141	4096 x 2160 @ 60.00 Hz	HDMI 2.0
F142	4096 x 2160 @ 50.00 Hz	HDMI 2.0
F143	Universal HDMI EDID; 4K, PCM audio	
F144	Universal HDMI EDID; 4K, all audio	
F145	Reserved	
F146	3840 x 2160 @ 60.00 Hz	HDMI 2.0
F147	3840 x 2160 @ 60.00 Hz	HDMI 2.0
F148	3840 x 2160 @ 60.00 Hz	HDMI 2.0

## 10.6. Mechanical Drawings

### 10.6.1. HDMI20-OPTC-TX220-Pro

The following drawings present the physical dimensions of the transmitter. Dimensions are in mm.

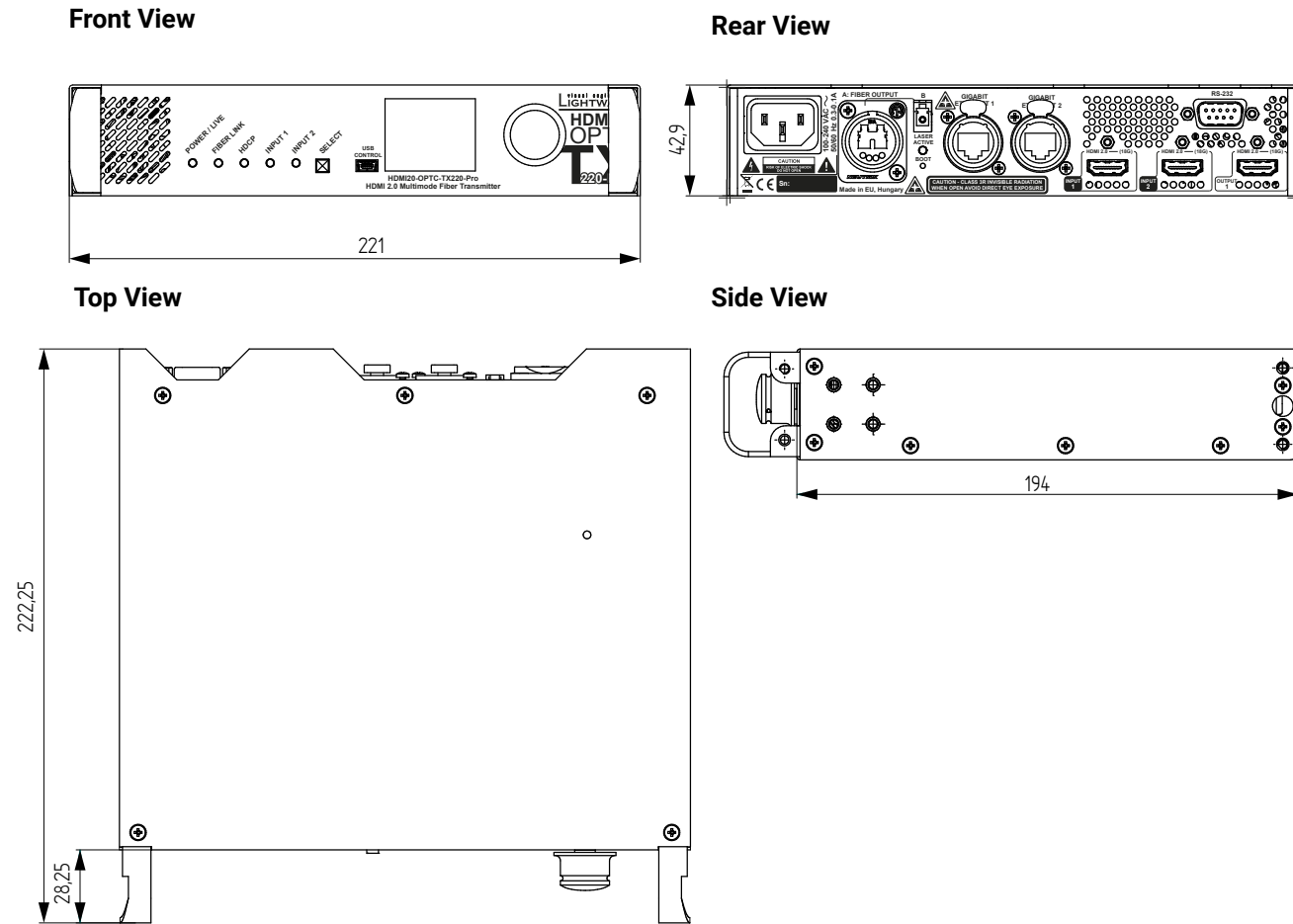

### 10.6.2. HDMI20-OPTC-RX220-Pro

The following drawings present the physical dimensions of the receiver. Dimensions are in mm.

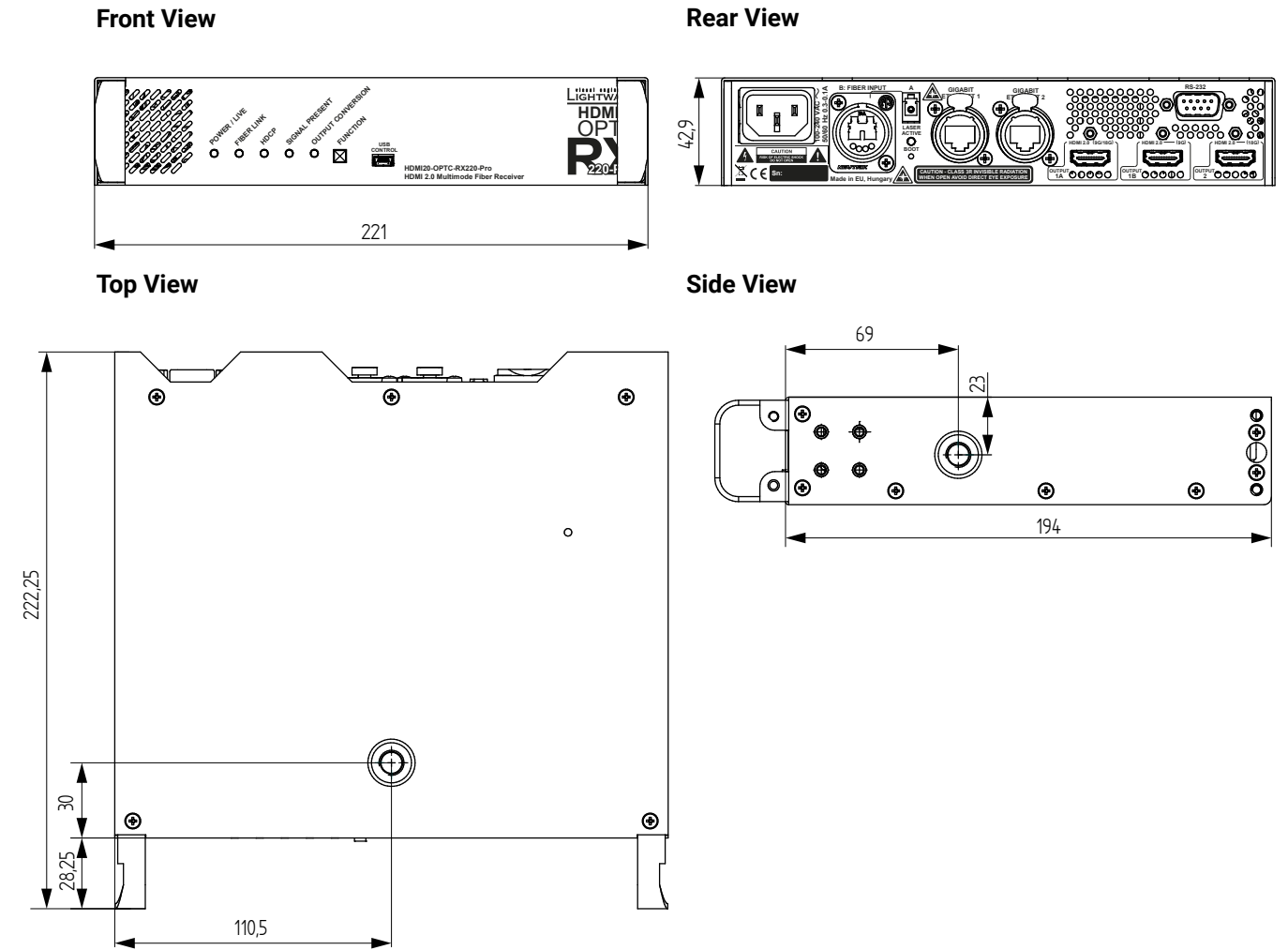



## 10.7. Further Information

### Limited Warranty Statement

1. Lightware Visual Engineering LLC (Lightware) warrants to all trade and end user customers that any Lightware product purchased will be free from manufacturing defects in both material and workmanship for three (3) years from purchase unless stated otherwise below. The warranty period will begin on the latest possible date where proof of purchase/delivery can be provided by the customer. In the event that no proof can be provided (empty 'Date of purchase' field or a copy of invoice), the warranty period will begin from the point of delivery from Lightware.

1.1. 25G and MODEX product series will be subject to a seven (7) year warranty period under the same terms as outlined in this document.

1.2. If during the first three (3) months of purchase, the customer is unhappy with any aspect of a Lightware product, Lightware will accept a return for full credit.

1.3. Any product that fails in the first six (6) months of the warranty period will automatically be eligible for replacement and advanced replacement where available. Any replacements provided will be warranted for the remainder of the original unit's warranty period.

1.4. Product failures from six (6) months to the end of the warranty period will either be repaired or replaced at the discretion of Lightware. If Lightware chooses to replace the product then the replacement will be warranted for the remainder of the original unit's warranty period.

2. The above-stated warranty and procedures will not apply to any product that has been:

2.1. Modified, repaired or altered by anyone other than a certified Lightware engineer unless expressly agreed beforehand.

2.2. Used in any application other than that for which it was intended.

2.3. Subjected to any mechanical or electrical abuse or accidental damage.

2.4. Any costs incurred for repair/replacement of goods that fall into the above categories (2.1., 2.2., 2.3.) will be borne by the customer at a pre-agreed figure.

3. All products to be returned to Lightware require a return material authorization number (RMA) prior to shipment and this number must be clearly marked on the box. If an RMA number is not obtained or is not clearly marked on the box, Lightware will refuse the shipment.

3.1. The customer will be responsible for in-bound and Lightware will be responsible for out-bound shipping costs.

3.2. Newly repaired or replaced products will be warranted to the end of the originally purchased products warranty period.

### Document Revision History

Rev.	Release date	Changes	Editor
1.0	08-11-2017	Initial version	Judit Barsony
1.1	28-02-2018	Correction of the appl. diagram and the description, add info to the conversion modes, HDCP related info	Judit Barsony

### Contact Us

[sales@lightware.com](mailto:sales@lightware.com)

+36 1 255 3800

[support@lightware.com](mailto:support@lightware.com)

+36 1 255 3810

**Lightware Visual Engineering LLC.**

Peterdy 15, Budapest H-1071, Hungary

[www.lightware.com](http://www.lightware.com)

©2018 Lightware Visual Engineering. All rights reserved. All trademarks mentioned are the property of their respective owners. Specifications subject to change without notice.